

2024 FORD MOTORHOME Owner's Manual

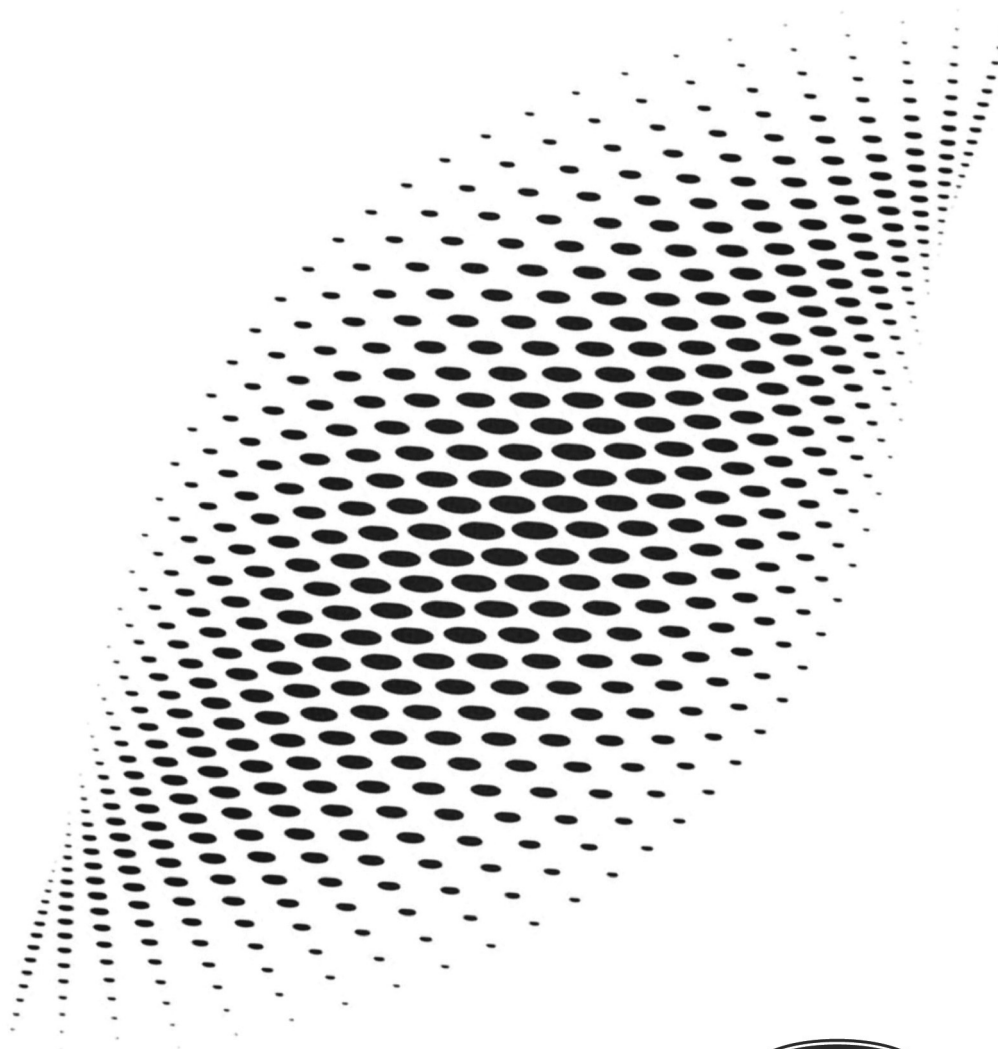

The information contained in this publication was correct at the time of release. In the interest of continuous development, we reserve the right to change specifications, design or equipment at any time without notice or obligation. No part of this publication may be reproduced, transmitted, stored in a retrieval system or translated into any language in any form by any means without our written permission. Errors and omissions excepted.

© Ford Motor Company 2023

All rights reserved.

Part Number: -202310-20231030135855

California Proposition 65



WARNING: Operating, servicing and maintaining a passenger vehicle or off-highway motor vehicle can expose you to chemicals including engine exhaust, carbon monoxide, phthalates, and lead, which are known to the State of California to cause cancer and birth defects or other reproductive harm. To minimize exposure, avoid breathing exhaust, do not idle the engine except as necessary, service your vehicle in a well-ventilated area and wear gloves or wash your hands frequently when servicing your vehicle. For more information go to www.P65Warnings.ca.gov/passenger-vehicle.



WARNING: Battery posts, terminals and related accessories contain lead and lead compounds, chemicals known to the State of California to cause cancer and reproductive harm.
Wash your hands after handling.

Table of Contents

Introduction

About This Manual	5
Symbols Glossary	5
Perchlorate	8
Ford Credit	8
Replacement Parts Recommendation	8
Special Notices	9
Mobile Communications Equipment	10
Export Unique Options	10

Data Privacy

Data Privacy	11
Service Data	12
Event Data	12
Settings Data	13
Connected Vehicle Data	13
Emergency Call System Data	14

Environment

Protecting the Environment	15
----------------------------------	----

Steering Wheel

Adjusting the Steering Wheel	16
Cruise Control - Vehicles With: Adaptive Cruise Control	16
Cruise Control - Vehicles With: Cruise Control	16
Information Display Control	17
Horn	17

Wipers and Washers

Windshield Wipers	18
Windshield Washers	18

Lighting

Lighting Control	19
Autolamps	19
Instrument Lighting Dimmer	20

Daytime Running Lamps - Vehicles With: Daytime Running Lamps (DRL)	20
Daytime Running Lamps - Vehicles With: Configurable Daytime Running Lamps	20
Direction Indicators	21

Automatic High Beam Control

What Is Automatic High Beam Control	22
Switching Automatic High Beam Control On and Off	22
Automatic High Beam Control Indicators	22
Overriding Automatic High Beam Control	23

Instrument Cluster

Gauges	24
Warning Lamps and Indicators	27
Audible Warnings and Indicators	29

Information Displays

General Information	30
Information Messages	34

Starting and Stopping the Engine

General Information	38
Ignition Switch	38
Starting a Gasoline Engine	39
Engine Block Heater	40

Fuel and Refueling

Safety Precautions	42
Fuel Quality	42
Running Out of Fuel	43
Refueling	44
Fuel Consumption	45

Table of Contents

Engine Emission Control

Emission Law	47
Catalytic Converter	48

Transmission

Automatic Transmission	51
------------------------------	----

Brakes

General Information	55
Hints on Driving With Anti-Lock Brakes	56
Parking Brake	56
Hill Start Assist	57

Traction Control

Principle of Operation	58
Using Traction Control	58

Stability Control

Principle of Operation	59
------------------------------	----

Cruise Control

What Is Cruise Control	61
Switching Cruise Control On and Off	61
Setting the Cruise Control Speed	61
Canceling the Set Speed	62
Resuming the Set Speed	62
Cruise Control Indicators	62
Using Adaptive Cruise Control	62

Driving Aids

Driver Alert	69
Lane Keeping System	70
Steering	73
Pre-Collision Assist	73

Load Carrying

Load Limit	78
------------------	----

Towing

Towing a Trailer	83
Recommended Towing Weights	84
Essential Towing Checks	85
Towing the Vehicle on Four Wheels	87

Driving Hints

Reduced Engine Performance	88
Economical Driving	88
Breaking-In	89
Driving Through Water	89

Roadside Emergencies

Hazard Flashers	90
Jump Starting the Vehicle	90
Transporting the Vehicle	92

Crash and Breakdown Information

Roadside Assistance	93
---------------------------	----

Customer Assistance

Getting the Services You Need	95
In California (U.S. Only)	96
The Better Business Bureau (BBB) Auto Line Program (U.S. Only)	97
Getting Assistance Outside the U.S. and Canada	98
Ordering Additional Owner's Literature	99
Reporting Safety Defects (U.S. Only)	99
Reporting Safety Defects (Canada Only)	100

Fuses

Fuse Specification Chart	101
Changing a Fuse	108

Table of Contents

Maintenance

General Information	110
Under Hood Overview - Commercial Chassis	111
Under Hood Overview - Motorhome Chassis	112
Engine Oil Dipstick	113
Engine Oil Check	113
Oil Change Indicator Reset	114
Changing the Engine Air Filter	114
Engine Coolant Check	115
Automatic Transmission Fluid Check	119
Brake Fluid Check	121
Power Steering Fluid Check	122
Changing the 12V Battery	124
Fuel Filter	125

Vehicle Care

General Information	126
Cleaning Products	126
Cleaning the Exterior	127
Cleaning the Engine	128
Cleaning the Wheels	128
Vehicle Storage	129

Wheels and Tires

Tire Care	131
Using Snow Chains	147
Technical Specifications	148

Capacities and Specifications

Engine Specifications	149
Motorcraft Parts	150
Vehicle Identification Number	151
Transmission Code Designation	152
Capacities and Specifications	153

Connected Vehicle

Connected Vehicle Requirements	160
Connected Vehicle Limitations	160
Connecting the Vehicle to a Mobile Network	160
Connecting the Vehicle to a Wi-Fi Network	160
Connected Vehicle – Troubleshooting	161

Ford Protect

Ford Protect	163
--------------------	-----

Scheduled Maintenance

General Maintenance Information	165
Normal Scheduled Maintenance	168
Special Operating Conditions Scheduled Maintenance	170

Customer Information

Radio Frequency Certification Labels	173
Warranty Information	177

Appendices

Electromagnetic Compatibility	179
-------------------------------------	-----

Introduction

ABOUT THIS MANUAL

Thank you for choosing Ford. We recommend that you take some time to get to know your vehicle by reading this manual. The more that you know about your vehicle, the greater the safety and pleasure you will get from driving it.



WARNING: Driving while distracted can result in loss of vehicle control, crash and injury. We strongly recommend that you use extreme caution when using any device that may take your focus off the road. Your primary responsibility is the safe operation of your vehicle. We recommend against the use of any hand-held device while driving and encourage the use of voice-operated systems when possible. Make sure you are aware of all applicable local laws that may affect the use of electronic devices while driving.

Note: *This manual describes product features and options available throughout the range of available models, sometimes even before they are generally available. It may describe options not fitted to the vehicle you have purchased.*

Note: *Some of the illustrations in this manual may show features as used in different models, so may appear different to you on your vehicle.*

Note: *Always use and operate your vehicle in line with all applicable laws and regulations.*

Note: *Pass on this manual when selling your vehicle. It is an integral part of your vehicle.*

Note: *Either Ford Motor Company or an authorized Ford dealer may have originally sold this incomplete vehicle to a vehicle modifier who upfitted it. As a result, it may have different options and features than described in this manual.*

This manual may qualify the location of a component as left-hand side or right-hand side. The side is determined when facing forward in the seat.

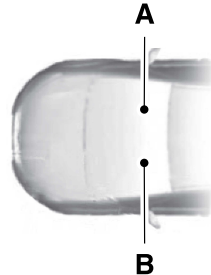

- A Right-hand side.
- B Left-hand side.

SYMBOLS GLOSSARY

These are some of the symbols you may see on your vehicle.



Airbag



Air conditioning system



Air conditioning system lubricant type



Anti-lock braking system

Introduction



Avoid smoking, flames or sparks



Engine air filter



Battery



Engine coolant



Battery acid



Engine coolant temperature



Blower motor



Engine oil



Brake fluid - non petroleum based



Explosive gas



Brake system



Fan warning



Brake system



Fasten seatbelt



Cabin air filter



Flammable



Check fuel cap



Front fog lamps



Child safety door lock or unlock



Fuel pump reset



Child seat lower anchor



Fuse compartment



Child seat tether anchor



Hazard flashers



Cruise control



Headlamp high beams



Do not open when hot



Headlamps on



Electric Parking brake



Heated rear window

Introduction



Hill descent control



Horn control



Interior luggage compartment release



Jack



Keep out of reach of children



Lighting control



Low fuel level



Low tire pressure warning



Maintain correct fluid level



Malfunction Indicator Lamp (MIL)



Note operating instructions



Panic alarm



Parking aid



Parking lamps



Passenger airbag activated



Passenger airbag deactivated



Power steering fluid



Power windows front/rear



Power window lockout



Requires registered technician



Safety alert



See Owner's Manual



See Service Manual



Side airbag



Shield the eyes



Stability control



Stability control off



Trail control



Turn Signal



Windshield defrosting system

Introduction



Windshield wiping system



Windshield wash and wipe

PERCHLORATE

Certain components in your vehicle such as airbag modules, seatbelt pretensioners and remote control batteries may contain perchlorate material. Special handling may apply for service or vehicle end of life disposal.

For more information visit:

Web Address
www.dtsc.ca.gov/hazardouswaste/perchlorate

FORD CREDIT

US Only

Ford Credit offers a full range of financing and lease plans to help you acquire your vehicle. If you have financed or leased your vehicle through Ford Credit, thank you for your business.

For assistance call 1-800-727-7000, or for more information about Ford Credit and access to the online Account Manager tool, visit www.ford.com/finance.

REPLACEMENT PARTS RECOMMENDATION

We have built your vehicle to the highest standards using quality parts. We recommend that you demand the use of genuine Ford and Motorcraft parts whenever your vehicle requires scheduled maintenance or repair. You can clearly identify genuine Ford and Motorcraft parts by looking for the Ford, FoMoCo or Motorcraft branding on the parts or their packaging.

Scheduled Maintenance and Mechanical Repairs

One of the best ways for you to make sure that your vehicle provides years of service is to have it maintained in line with our recommendations using parts that conform to the specifications detailed in this Owner's Manual.

Genuine Ford and Motorcraft parts meet or exceed these specifications.

Collision Repairs

We hope that you never experience a collision, but accidents happen sometimes.

Genuine Ford replacement collision parts meet our stringent requirements for fit, finish, structural integrity, corrosion protection and dent resistance. During vehicle development we validate that these parts deliver the intended level of protection as a whole system. A great way to know for sure you are getting this level of protection is to use genuine Ford replacement collision parts.

Warranty on Replacement Parts

Genuine Ford and Motorcraft replacement parts are the only replacement parts that benefit from a Ford Warranty.

Introduction

The Ford Warranty may not cover damage caused to your vehicle as a result of failed non-Ford parts.

For additional information, refer to the terms and conditions of the Ford Warranty.

SPECIAL NOTICES

New Vehicle Limited Warranty

For a detailed description of what is covered by your New Vehicle Limited Warranty, see your warranty guide that is available online. For more information, refer to our website and download your copy of the warranty guide.

Special Instructions

For your added safety, your vehicle is fitted with sophisticated electronic controls.



WARNING: You risk death or serious injury to yourself and others if you do not follow the instruction highlighted by the warning symbol. Failure to follow the specific warnings and instructions could result in personal injury.



WARNING: NEVER use a rearward facing child restraint on a seat protected by an ACTIVE AIRBAG in front of it, DEATH or SERIOUS INJURY to the CHILD can occur.

On Board Diagnostics Data Link Connector



WARNING: Do not connect wireless plug-in devices to the data link connector. Unauthorized third parties could gain access to vehicle data and impair the performance of safety related systems. Only allow repair facilities that follow our service and repair instructions to connect their equipment to the data link connector.

Your vehicle has an OBD Data Link Connector (DLC) that is used in conjunction with a diagnostic scan tool for vehicle diagnostics, repairs and reprogramming services. Installing an aftermarket device that uses the DLC during normal driving for purposes such as remote insurance company monitoring, transmission of vehicle data to other devices or entities, or altering the performance of the vehicle, may cause interference with or even damage to vehicle systems. We do not recommend or endorse the use of unapproved aftermarket plug-in devices. The vehicle Warranty will not cover damage caused by an aftermarket plug-in device.

Notice to Owners of Pickup Trucks and Utility Type Vehicles



WARNING: Utility vehicles have a significantly higher rollover rate than other types of vehicles.

Before you drive your vehicle, please read this Owner's Guide carefully. Your vehicle is not a passenger car. As with other vehicles of this type, failure to operate this vehicle correctly may result in loss of vehicle control, vehicle rollover, personal injury or death.

Introduction

Using Your Vehicle With a Snowplow

Do not use this vehicle for snowplowing.

Your vehicle does not have a snowplowing package.

Using Your Vehicle as an Ambulance

Do not use this vehicle as an ambulance.

Your vehicle does not have the Ambulance Preparation Package.

MOBILE COMMUNICATIONS EQUIPMENT



WARNING: Driving while distracted can result in loss of vehicle control, crash and injury. We strongly recommend that you use extreme caution when using any device that may take your focus off the road. Your primary responsibility is the safe operation of your vehicle. We recommend against the use of any hand-held device while driving and encourage the use of voice-operated systems when possible. Make sure you are aware of all applicable local laws that may affect the use of electronic devices while driving.

Using mobile communications equipment is becoming increasingly important in the conduct of business and personal affairs. However, you must not compromise your own or others' safety when using such equipment. Mobile communications can enhance personal safety and security when appropriately used, particularly in emergency situations. Safety must be paramount when using mobile

communications equipment to avoid negating these benefits. Mobile communication equipment includes, but is not limited to, cellular phones, pagers, portable email devices, text messaging devices and portable two-way radios.

EXPORT UNIQUE OPTIONS

For your particular global region, your vehicle may be equipped with features and options that are different from the features and options that are described in this Owner's Manual. A market unique supplement may be supplied that complements this book. By referring to the market unique supplement, if provided, you can properly identify those features, recommendations and specifications that are unique to your vehicle. This Owner's Manual is written primarily for the U.S. and Canadian Markets. Features or equipment listed as standard may be different on units built for export. **Refer to this Owner's Manual for all other required information and warnings.**

Data Privacy



WARNING: Do not connect wireless plug-in devices to the data link connector. Unauthorized third parties could gain access to vehicle data and impair the performance of safety related systems. Only allow repair facilities that follow our service and repair instructions to connect their equipment to the data link connector.

We respect your privacy and are committed to protecting it. The information contained in this publication was correct at the time of release, but as technology rapidly changes, we recommend that you visit the local Ford website for the latest information.

Your vehicle has electronic control units that have data recording functionality and the ability to permanently or temporarily store data. This data could include information on the condition and status of your vehicle, vehicle maintenance requirements, events and malfunctions. The types of data that can be recorded are described in this section. Some of the data recorded is stored in event logs or error logs.

Note: *Error logs are reset following a service or repair.*

Note: *We may provide information in response to requests from law enforcement, other government authorities and third parties acting with lawful authority or through a legal process. Such information could be used by them in legal proceedings.*

Data recorded includes, for example:

- Operating states of system components, for example fuel level, tire pressure and battery charge level.
- Vehicle and component status, for example wheel speed, deceleration, lateral acceleration and seatbelt status.

- Events or errors in essential systems, for example headlamps and brakes.
- System responses to driving situations, for example airbag deployment and stability control.
- Environmental conditions, for example temperature.

Some of this data, when used in combination with other information, for example an accident report, damage to a vehicle or eyewitness statements, could be associated with a specific person.

Services That We Provide

If you use our services, we collect and use data, for example account information, vehicle location and driving characteristics, that could identify you. We transmit this data through a dedicated, protected connection. We only collect and use data to enable your use of our services to which you have subscribed, with your consent or where permitted by law. For additional information, see the terms and conditions of the services to which you have subscribed.

For additional information about our privacy policy, refer to the local Ford website.

Services That Third Parties Provide

We recommend that you review the terms and conditions and data privacy information for any services equipped with your vehicle or to which you subscribe. We take no responsibility for services that third parties provide.

Data Privacy

SERVICE DATA

Service data recorders in your vehicle are capable of collecting and storing diagnostic information about your vehicle. This potentially includes information about the performance or status of various systems and modules in the vehicle, such as engine, throttle, steering or brake systems. In order to properly diagnose and service your vehicle, Ford Motor Company (Ford of Canada in Canada), and service and repair facilities may access or share among them vehicle diagnostic information received through a direct connection to your vehicle when diagnosing or servicing your vehicle. Additionally, Ford Motor Company (Ford of Canada, in Canada) may, where permitted by law, use vehicle diagnostic information for vehicle improvement or with other information we may have about you, for example, your contact information, to offer you products or services that may interest you. Data may be provided to our service providers such as part suppliers that may help diagnose malfunctions, and who are similarly obligated to protect data. We retain this data only as long as necessary to perform these functions or to comply with law. We may provide information where required in response to official requests to law enforcement or other government authorities or third parties acting with lawful authority or court order, and such information may be used in legal proceedings. For U.S. only (if equipped), if you choose to use connected apps and services, you consent that certain diagnostic information may also be accessed electronically by Ford Motor Company and Ford authorized service facilities, and that the diagnostic information may be used to provide services to you, personalizing your experience, troubleshoot, and to improve products and services and offer you products and services that may interest

you, where permitted by law. For Canada only, for more information, please review the Ford of Canada privacy policy at www.ford.ca, including our U.S. data storage and use of service providers in other jurisdictions who may be subject to legal requirements in Canada, the United States and other countries applicable to them, for example, lawful requirements to disclose personal information to governmental authorities in those countries.

EVENT DATA

This vehicle is equipped with an event data recorder. The main purpose of an event data recorder is to record, in certain crash or near crash-like situations, such as an airbag deployment or hitting a road obstacle; this data will assist in understanding how a vehicle's systems performed. The event data recorder is designed to record data related to vehicle dynamics and safety systems for a short period of time, typically 30 seconds or less.

The event data recorder in this vehicle is designed to record such data as:

- How various systems in your vehicle were operating.
- Whether or not the driver and passenger seatbelts were buckled/fastened.
- How far (if at all) the driver was depressing the accelerator and/or the brake pedal.
- How fast the vehicle was traveling.
- Where the driver was positioning the steering wheel.

This data can help provide a better understanding of the circumstances in which crashes and injuries occur.

Data Privacy

Note: Event data recorder data is recorded by your vehicle only if a non-trivial crash situation occurs; no data is recorded by the event data recorder under normal driving conditions and no personal data or information (for example name, gender, age, and crash location) is recorded. However, parties, such as law enforcement, could combine the event data recorder data with the type of personally identifying data routinely acquired during a crash investigation.

To read data recorded by an event data recorder, special equipment is required, and access to the vehicle or the event data recorder is needed. In addition to the vehicle manufacturer, other parties, such as law enforcement, that have such special equipment, can read the information if they have access to the vehicle or the event data recorder.

SETTINGS DATA

Your vehicle has electronic control units that have the ability to store data based on your personalized settings. The data is stored locally in the vehicle or on devices that you connect to it, for example, a USB drive or digital music player. You can delete some of this data and also choose whether to share it through the services to which you subscribe.

Comfort and Convenience Data

Data recorded includes, for example:

- Seat and steering wheel position.
- Climate control settings.
- Radio presets.

Entertainment Data

Data recorded includes, for example:

- Music, videos or album art.
- Contacts and corresponding address book entries.
- Navigation destinations.

CONNECTED VEHICLE DATA



The modem has a SIM. The modem was enabled when your vehicle was built and periodically sends messages to stay connected to the cell phone network, receive automatic software updates and send vehicle-related information to us, for example diagnostic information. These messages could include information that identifies your vehicle, the SIM and the electronic serial number of the modem. Cell phone network service providers could have access to additional information, for example cell phone network tower identification. For additional information about our privacy policy, visit www.FordConnected.com or refer to your local Ford website.

Note: The modem continues to send this information unless you disable the modem or stop the modem from sharing vehicle data by changing the modem settings. See **Connected Vehicle** (page 160).

Note: The service can be unavailable or interrupted for a number of reasons, for example environmental or topographical conditions and data plan coverage.

Note: To find out if your vehicle has a modem, visit www.FordConnected.com.

EMERGENCY CALL SYSTEM DATA (IF EQUIPPED)

When the emergency call system is active, it may disclose to emergency services that your vehicle has been in a crash involving the deployment of an airbag or activation of the fuel pump shut-off. Certain versions or updates to the emergency call system may also be capable of electronically or verbally disclosing to emergency services operators your vehicle location or other details about your vehicle or crash to assist emergency services operators to provide the most appropriate emergency services. If you do not want to disclose this information, do not activate the emergency call system.

Note: *You cannot deactivate emergency call systems that are required by law.*

Environment

PROTECTING THE ENVIRONMENT

Sustainability is a priority at Ford. We are constantly looking for ways to reduce our impact on the planet while providing customers with great products and delivering a strong business. You should play your part in protecting the environment. Correct vehicle usage and the authorized disposal of waste, cleaning and lubrication materials are significant steps toward this aim.

For additional information about our sustainability progress and initiatives, visit www.sustainability.ford.com.

Steering Wheel

ADJUSTING THE STEERING WHEEL



WARNING: Do not adjust the steering wheel when your vehicle is moving.

Note: Make sure that you are sitting in the correct position.

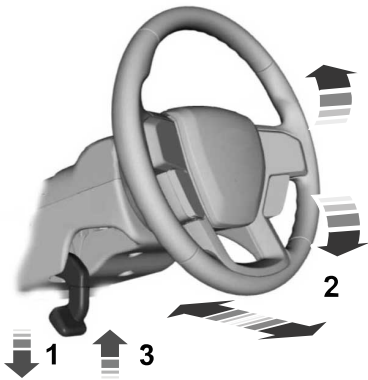

1. Unlock the steering column.
2. Adjust the steering wheel to the position you prefer.
3. Lock the steering column.

CRUISE CONTROL - VEHICLES WITH: ADAPTIVE CRUISE CONTROL



E191337

See **Using Adaptive Cruise Control** (page 62).

CRUISE CONTROL - VEHICLES WITH: CRUISE CONTROL



E191329

See **What Is Cruise Control** (page 61).

Steering Wheel

INFORMATION DISPLAY CONTROL



E191336

See **Information Displays** (page 30).

HORN



Wipers and Washers

WINDSHIELD WIPERS

Note: Fully defrost the windshield before you switch the windshield wipers on.

Note: Make sure you switch the windshield wipers off before entering a car wash.

Note: If streaks or smears appear on the windshield, clean the windshield and the wiper blades. If that does not resolve the issue, install new wiper blades.

Note: Do not operate the wipers on a dry windshield. This may scratch the glass, damage the wiper blades or cause the wiper motor to burn out. Always use the windshield washers before wiping a dry windshield.

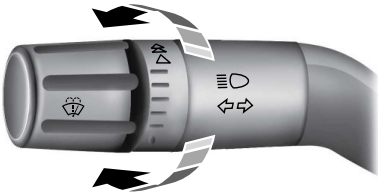

E172816

Use the rotary control to adjust the intermittent wipe interval:

- Rotate the control away from you for a long wipe interval.
- Rotate the control toward you for a short wipe interval.

WINDSHIELD WASHERS

Note: Do not operate the wipers on a dry windshield. This may scratch the glass, damage the wiper blades or cause the wiper motor to burn out. Always use the windshield washer before wiping a dry windshield.

Note: Do not operate the washers when the washer reservoir is empty. This may cause the washer pump to overheat.

Press the end of the stalk to activate the washer.

- A brief press causes a single wipe without washer fluid.
- A quick press and hold cause the wipers to swipe three times with washer fluid.
- A long press and hold activates the wipers and washer fluid for up to 10 seconds.



E172818

Lighting

LIGHTING CONTROL

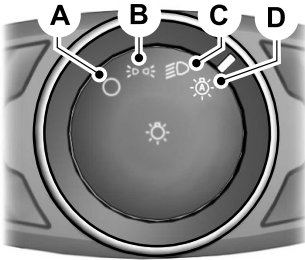

- A Lamps off.
- B Parking lamps, instrument panel lamps, license plate lamps and rear lamps.
- C Headlamps.
- D Autolamps.

Headlamp High Beam

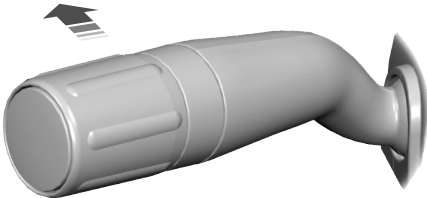

Push the lever away from you to switch the high beam on.

Push the lever forward again or pull the lever toward you to switch the high beams off.

Flashing the Headlamp High Beam

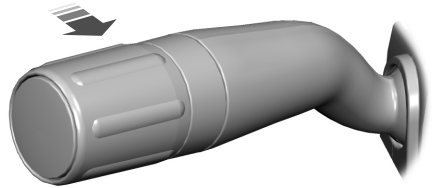

Slightly pull the lever toward you and release it to flash the headlamps.

AUTOLAMPS



WARNING: The system does not relieve you of your responsibility to drive with due care and attention. You may need to override the system if it does not turn the headlamps on in low visibility conditions, for example daytime fog.

Autolamps turn the headlamps on in low light situations or when the wipers operate.



Switch the lighting control to the autolamps position.

The headlamps remain on for a period of time after you switch the ignition off. Use the information display controls to adjust the period of time that the headlamps remain on.

Note: *If you switch the autolamps on, you cannot switch the high beams on until the system turns the low beams on.*

Lighting

Windshield Wiper Activated Headlamps

When you switch the autolamps on, the headlamps turn on within 10 seconds of switching the wipers on. They turn off approximately 60 seconds after you switch the windshield wipers off.

The headlamps do not turn on with the wipers:

- During a single wipe.
- When using the windshield washers.
- If the wipers are in intermittent mode.

Note: *If you switch the autolamps and the autowipers on, the headlamps turn on when the windshield wipers continuously operate.*

INSTRUMENT LIGHTING DIMMER

The instrument lighting dimmer buttons are on the lighting control.



Repeatedly press one of the buttons to adjust the brightness.



DAYTIME RUNNING LAMPS - VEHICLES WITH: DAYTIME RUNNING LAMPS (DRL)



WARNING: The daytime running lamps system does not activate the rear lamps and may not provide adequate lighting during low visibility driving conditions. Make sure you switch the headlamps on, as appropriate, during all low visibility conditions. Failure to do so may result in a crash.

The system turns the lamps on in daylight conditions.

To switch the system on, switch the lighting control to any position except headlamps.

DAYTIME RUNNING LAMPS - VEHICLES WITH: CONFIGURABLE DAYTIME RUNNING LAMPS



WARNING: The daytime running lamps system does not activate the rear lamps and may not provide adequate lighting during low visibility driving conditions. Make sure you switch the headlamps on, as appropriate, during all low visibility conditions. Failure to do so may result in a crash.

Switch the daytime running lamps on or off using the information display. See **General Information** (page 30).

The daytime running lamps turn on when:

1. The lamps are on in the information display.
2. You switch the ignition on.
3. The transmission is not in park (P) for vehicles with automatic transmissions or you release the parking brake for vehicles with manual transmissions.
4. The lighting control is in the autolamps position.
5. The headlamps are off.

The other lighting control switch positions do not turn on the daytime running lamps.

If the daytime running lamps are off in the information display, the lamps stay off in all switch positions.

Lighting

DIRECTION INDICATORS

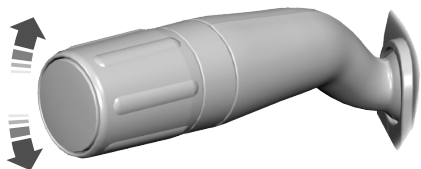

Push the lever up or down to use the direction indicators.

Note: *Push the direction indicator lever up or down to use the direction indicators.*

Automatic High Beam Control (If Equipped)

WHAT IS AUTOMATIC HIGH BEAM CONTROL

The system turns on high beams if it is dark enough and no other traffic is present. If it detects an approaching vehicle's headlamps or tail lamps, or street lighting ahead, the system turns the high beams off. Low beams remain on.

A camera sensor, centrally mounted behind the windshield of your vehicle, continuously monitors conditions to turn the high beams on and off.

SWITCHING AUTOMATIC HIGH BEAM CONTROL ON AND OFF

Switch the system on or off using the information display. See **General Information** (page 30).

Activating the Automatic High Beam Control



Switch the lighting control to the autolamps position to activate. See **Autolamps** (page 19).

Note: Automatic high beams are not available when you do not turn on autolamps.

When active, the high beams turn on if all of the following occur:

- The ambient light level is low enough.
- There is no traffic in front of your vehicle.
- The vehicle speed is greater than approximately 32 mph (52 km/h).

When active, the high beams turn off if any of the following occur:

- The ambient light level is high enough that it does not require high beams.
- The system detects an approaching vehicle's headlamps or tail lamps.

- The system detects severe rain, snow or fog.
- The camera is blocked.
- The vehicle speed falls below approximately 27 mph (44 km/h).

Note: The deactivation speed is lower on curves.

Note: There could be a delay in high beam reactivation in certain curvy road situations.

Note: If you have a blocked sensor, the system may not operate properly. Keep the windshield free from obstruction or damage.

Note: The system may not operate properly in cold or inclement conditions. You can switch on the high beams by overriding the system.

Note: If the system detects a blockage, for example bird droppings, bug splatter, snow or ice, the system goes into low beam mode until you clear the blockage. If you have a blocked camera, a message may appear in the information display.

Note: Using much larger tires or equipping vehicle accessories such as snowplows can modify your vehicle's ride height and degrade automatic high beam control performance.

AUTOMATIC HIGH BEAM CONTROL INDICATORS



The indicator illuminates to confirm when the system is ready to assist.

Automatic High Beam Control (If Equipped)

OVERRIDING AUTOMATIC HIGH BEAM CONTROL



WARNING: The system does not relieve you of your responsibility to drive with due care and attention. You may need to override the system if it does not turn the high beams on or off.



WARNING: You may need to override the system when approaching other road users.



WARNING: You may need to override the system during inclement weather.

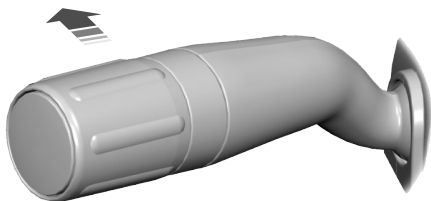

Push the lever away from you to switch between high beam and low beam.

Instrument Cluster

GAUGES

2.3 Inch Display

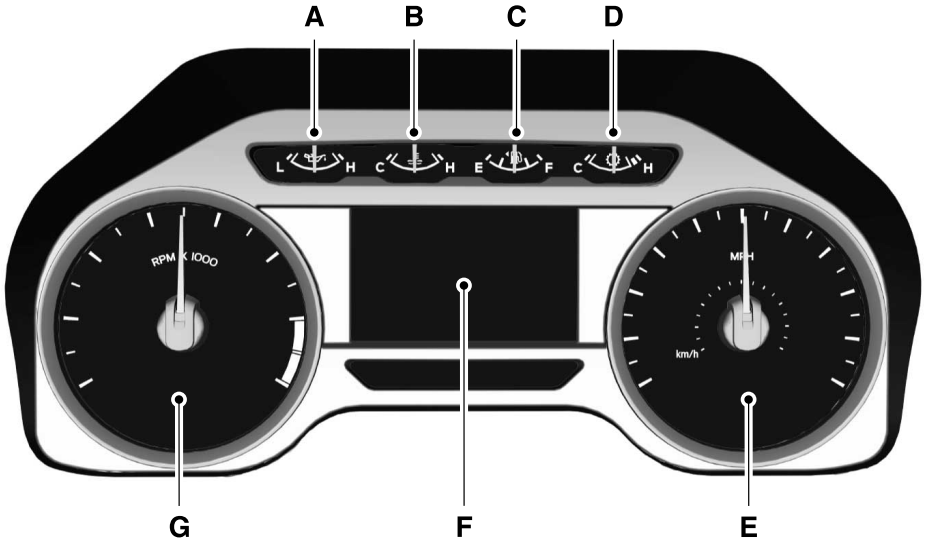

- A Engine oil pressure gauge.
- B Engine coolant temperature gauge.
- C Fuel gauge.
- D Transmission fluid temperature.
- E Speedometer.
- F Information display.
- G Tachometer.

Instrument Cluster

8 Inch Display

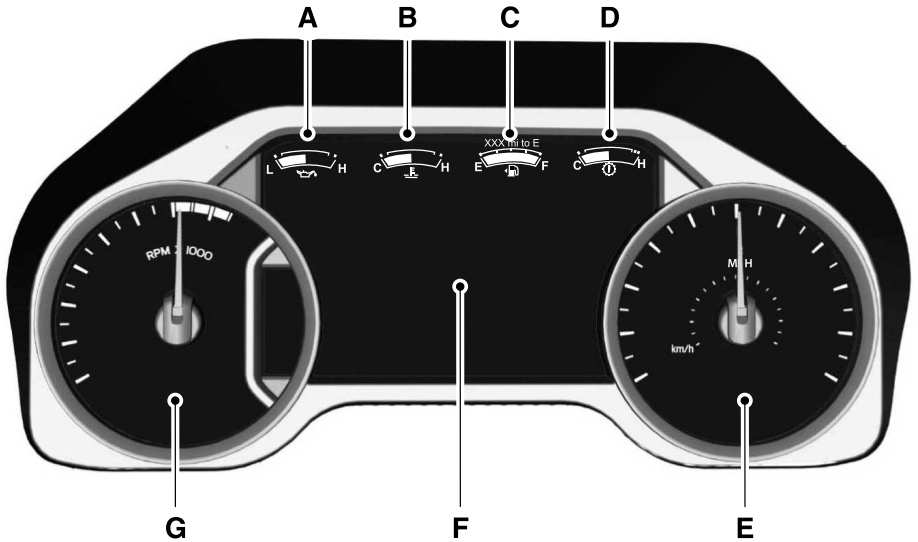

- A Engine oil pressure gauge.
- B Engine coolant temperature gauge.
- C Fuel gauge.
- D Configurable gauge.
- E Speedometer.
- F Information display.
- G Tachometer.

Instrument Cluster

Engine Oil Pressure Gauge

Indicates engine oil pressure. The needle should stay in the normal operating range, between the **L** and **H** marks. If the needle falls below the normal range, stop your vehicle, turn off the engine and check the engine oil level. Add oil if needed. If the oil level is correct and the gauge displays incorrectly, have your vehicle checked by an authorized dealer.

Engine Coolant Temperature Gauge



WARNING: Do not remove the coolant reservoir cap when the engine is on or the cooling system is hot. Wait 10 minutes for the cooling system to cool down. Cover the coolant reservoir cap with a thick cloth to prevent the possibility of scalding and slowly remove the cap. Failure to follow this instruction could result in personal injury.

Indicates engine coolant temperature. At normal operating temperature, the level indicator is in the normal range. If the engine coolant temperature exceeds the normal range, stop your vehicle as soon as possible, switch off the engine and let the engine cool.

Fuel Gauge

The fuel gauge indicates about how much fuel is in the fuel tank.

The arrow adjacent to the fuel pump symbol indicates on which side of your vehicle the fuel filler door is located.

Note: *The fuel gauge may vary slightly when your vehicle is moving or on a slope.*

Low Fuel Reminder

A low fuel level reminder displays and sounds when the distance to empty reaches 50 mi (80 km), 25 mi (40 km), 10 mi (20 km) and 0 mi (0 km).

Note: *The low fuel reminder can appear at different fuel gauge positions depending on fuel economy conditions. This variation is normal.*

Distance to Empty

Indicates the approximate distance your vehicle can travel on the fuel remaining in the tank. Changes in driving pattern can cause the value to not only decrease but also increase or stay constant for periods of time.

Configurable Gauge

Transmission Fluid Temperature Gauge

Indicates transmission fluid temperature. At normal operating temperature, the level indicator is in the normal range. If the transmission fluid temperature exceeds the normal range, stop your vehicle as soon as possible and verify the airflow is not restricted by snow or debris blocking airflow through the grille.

To lower the transmission temperature into the normal range, alter the severity of your driving conditions. Operating the transmission for extended periods with the gauge in the higher than normal area may cause internal transmission damage. If the gauge continues to show high temperatures, see an authorized dealer.

Voltmeter

Displays electrical system voltage.

Instrument Cluster

WARNING LAMPS AND INDICATORS

The following warning lamps and indicators alert you to a vehicle condition that may become serious. Some lamps illuminate when you start your vehicle to make sure they work. If any lamps remain on after starting your vehicle, refer to the respective system warning lamp for further information.

Note: *Some warning indicators appear in the information display and operate the same as a warning lamp but do not illuminate when you start your vehicle.*

Adaptive Cruise Control Indicator (If Equipped)



The speed control system indicator light changes color to indicate what mode the system is in.

On (white light): Illuminates when the adaptive cruise control system is turned on. Turns off when the speed control system is turned off.

Engaged (green light): Illuminates when the adaptive cruise control system is engaged. Turns off when the speed control system is disengaged.

Anti-Lock Brake System Warning Lamp



If it illuminates when you are driving, this indicates a malfunction. You will continue to have the normal braking system (without ABS) unless the brake system warning lamp is also illuminated. Have the system checked as soon as possible.

Autolamps Indicator



Illuminates when this feature is on. See **Autolamps** (page 19).

Battery



If it illuminates while driving, it indicates a malfunction. Switch off all unnecessary electrical equipment and have the system checked as soon as possible.

Brake System Warning Lamp



WARNING: Driving your vehicle with the warning lamp on is dangerous. A significant decrease in braking performance may occur. It may take you longer to stop your vehicle. Have your vehicle checked as soon as possible. Driving extended distances with the parking brake engaged can cause brake failure and the risk of personal injury.

Note: *Indicators vary depending on region.*

This lamp is a dual function lamp and will illuminate when:

- You apply the parking brake with the ignition on.
- Your vehicle has a brake fault or low brake fluid level, regardless of parking brake position.



If the lamp illuminates while you are moving, you may have the parking brake applied. Be sure that the parking brake is off. Have your vehicle checked as soon as possible if the lamp continues to illuminate.

Instrument Cluster

Cruise Control Indicator



Illuminates when you switch this feature on. See **What Is Cruise Control** (page 61).

Direction Indicator



Illuminates when you switch the left or right direction indicator or the hazard flasher on. If the indicators stay on or flash faster, check for a burned out bulb.

Electronic Throttle Control



Illuminates when the engine has defaulted to a limp-home operation. Have your vehicle checked as soon as possible.

Engine Coolant Temperature Warning Lamp



Illuminates when the engine coolant temperature is high. Stop the vehicle as soon as possible, switch off the engine and let cool.

Fasten Seatbelt Warning Lamp



It illuminates and a chime sounds until you fasten the seatbelts.

Headlamp High Beam Indicator



Illuminates when you switch the high beam headlamps on. It will flash when you use the headlamp flasher.

Hydromax (If Equipped)



If the light illuminates and remains on when the key is in the on position or the engine is running, this indicates inadequate hydraulic booster pressure or reserve pump system failure. Stop the vehicle as soon as possible and have your vehicle checked.

Lane Departure Warning Indicator (If Equipped)



Illuminates when the system activates. See **Lane Keeping System** (page 70).

Low Fuel Level Warning Lamp



Illuminates when the fuel level is low or the fuel tank is nearly empty. Refuel as soon as possible.

Oil Pressure Warning Lamp



If it illuminates with the engine running or when you are driving, this indicates a malfunction. Stop your vehicle as soon as it is safe to do so and switch the engine off. Check the engine oil level. See **Engine Oil Check** (page 113).

Parking Lamps



Illuminates when you switch the parking lamps on.

Service Engine Soon



If it illuminates when the engine is running this indicates a malfunction. The On Board Diagnostics system has detected a malfunction of the vehicle emission control system.

Instrument Cluster

If it flashes, engine misfire could be occurring. Increased exhaust gas temperatures could damage the catalytic converter or other vehicle components. Drive in a moderate fashion (avoid heavy acceleration and deceleration) and have your vehicle checked as soon as possible.

It illuminates when you switch the ignition on prior to engine start to check the bulb and to indicate whether your vehicle is ready for Inspection and Maintenance (I/M) testing.

Normally, it illuminates until the engine is cranked and automatically turns off if no malfunctions are present. However, if after 15 seconds it flashes eight times, this indicates that your vehicle is not ready for Inspection and Maintenance (I/M) testing. See **Emission Law** (page 47).

Stability Control Indicator (If Equipped)



Flashes during operation.

If it does not illuminate when you switch the ignition on, or remains on when the engine is running, this indicates a malfunction. Have your vehicle checked as soon as possible.

Traction Control Indicator



It flashes during a traction control event.

If it does not illuminate when you switch the ignition on, or remains on when the engine is running, this indicates a malfunction. Have your vehicle checked as soon as possible.

Traction Control System Off



Illuminates when you switch the system off.

Tow Haul Indicator



Illuminates when you switch the tow/haul feature on. If the light flashes steadily, immediately have the system serviced, damage to the transmission could occur.

AUDIBLE WARNINGS AND INDICATORS

Headlamps On Warning Chime

Sounds when you remove the key from the ignition and open the driver's door and you have left the headlamps or parking lamps on.

Key in Ignition Warning Chime

Sounds when you open the driver's door and you have left the key in the ignition.

Parking Brake On Warning Chime

Sounds when you have left the parking brake on and drive your vehicle. If the warning chime remains on after you have released the parking brake, have the system checked by your authorized dealer immediately.

Information Displays

GENERAL INFORMATION



WARNING: Driving while distracted can result in loss of vehicle control, crash and injury. We strongly recommend that you use extreme caution when using any device that may take your focus off the road. Your primary responsibility is the safe operation of your vehicle. We recommend against the use of any hand-held device while driving and encourage the use of voice-operated systems when possible. Make sure you are aware of all applicable local laws that may affect the use of electronic devices while driving.

Note: Trailer options are not available if your vehicle speed is greater than 3 mph (5 km/h).

Information Display Controls



- Press the up and down arrow buttons to scroll through and highlight the options within a menu.
- Press the right arrow button to enter a sub-menu.
- Press the left arrow button to exit a menu.
- Press the **OK** button to choose and confirm settings or messages.



This icon shows the features on or off status. A check in the box indicates the feature is on, and unchecked indicates the feature is off.

2.3 Inch Display Menu

Note: Some options could appear slightly different or not at all if the items are optional.

Main Menu
Trip 1
Trip 2
Fuel Economy
Driver Assist
Settings

Information Displays

Trip 1 or 2

Displays the following of an individual journey.

- Digital speed.
- Distance.
- Time.
- Distance to empty.
- Average fuel economy.

Note: Hold **OK** to reset fuel history and average fuel economy.

Fuel Economy

Displays the following:

- Instant fuel economy.
- Average fuel economy.
- Average speed.
- Distance to empty.

Note: Hold **OK** to reset fuel history and average fuel economy.

Driver Assist

Displays the following:

- Progressive range select.
- Engine hours.
- Maintenance monitor.

Settings

Settings		
Vehicle	Lighting	Select Your Setting
	Locks	
	FordPass	
	Windows	
	Wiper Controls	
Displ. Settings	Units	Select Your Setting
	Temperature	
	Language	

8 Inch Display Menu

Note: Some options could appear slightly different or not at all if the items are optional.

Information Displays

Main Menu
MyView
Trip/Fuel
Vehicle Info
Settings

MyView

MyView	
Trip 1	
Fuel Economy	
Configure MyView	For more options, press the OK button.

Trip/Fuel

Trip/Fuel
Trip 1
Trip 2
Fuel Economy
Fuel History

Trip 1 or 2

Displays the following of an individual journey.

- Trip timer.
- Distance to empty.
- Trip odometer.
- Average fuel economy.

Note: Hold **OK** to reset fuel history and average fuel economy.

Fuel Economy

Displays your instantaneous fuel usage as a bar graph and average mpg.

Fuel History

Displays your fuel usage based on time. The graph is updated each minute with the fuel economy that you achieved during 30 minutes of driving.

Information Displays

Vehicle Info

Vehicle Info
Gauge View
Digital Speedometer
Engine Information
Maintenance Monitor
Transmission Temp

- Engine Information - Shows engine hours, engine idle hours and engine oil temp and oil life.

Settings

Settings			
Driver Alert		Turn On or Off	
Pre-Collision		Select Your Setting	
Cruise Control		Select Your Setting	
Gauge Selection		Select Your Setting	
Advanced Settings	Vehicle	Lighting	Select Your Setting
		Locks	
		FordPass	
		Windows	
		Wiper Controls	
	Displ. Settings	Units	Select Your Setting
		Temperature	
		Tire Pressure	
		Language	

Information Displays

INFORMATION MESSAGES

Note: Depending on your vehicle options and instrument cluster type, not all messages display or are available. The instrument cluster display may shorten certain messages.

Press the **OK** button to acknowledge and remove some messages from the information display. The information display will automatically remove other messages after a short period of time.

You need to confirm certain messages before you can access the menus.



Battery and Charging System

Message	Action
Check Charging System	The charging system needs servicing. If the warning stays on or continues to come on, contact an authorized dealer as soon as possible.

Driver Alert

Message	Action
Driver Alert Warning Rest Now	Stop and rest as soon as it is safe to do so.
Driver Alert Warning Rest Suggested	Take a rest soon.

Engine

Message	Action
Power Reduced to Lower Engine Temp	The engine has reduced power to help reduce high engine temperature.

Information Displays

Fuel

Message	Action
Fuel Level Low	An early reminder of a low fuel condition.
Check Fuel Fill Inlet	The fuel fill inlet may not be properly closed.

Lane Departure Warning System

Message	Action
Front Camera Temporarily Not Available	The system has detected a condition that has caused the system to be temporarily unavailable. If the message continues to display, have the system checked as soon as possible.
Front Camera Low Visibility Clean Screen	The system has detected a condition that requires you to clean the windshield in order for it to operate properly.
Front Camera Malfunction Service Required	The system requires service, have the system checked as soon as possible.
Keep Hands on Steering Wheel	The system requests you to keep your hands on the steering wheel.

Maintenance

Message	Action
Low Engine Oil Pressure	Stop your vehicle as soon as safely possible and turn off the engine. Check the oil level. If the warning stays on or continues to come on with your engine running, contact an authorized dealer as soon as possible.
Change Engine Oil Soon	The engine oil life remaining is 10% or less.
Oil Change Required	The oil life left is at 0%.
Brake Fluid Level Low	The brake fluid level is low, inspect the brake system immediately. See Brake Fluid Check (page 121).

Information Displays

Message	Action
Check Brake System	The brake system needs servicing. Stop your vehicle in a safe place. Contact an authorized dealer.
Transport / Factory Mode Contact Dealer	Your vehicle is still in Transport or Factory mode. This may not allow some features to operate properly. See an authorized dealer.
See Manual	The powertrain needs service due to a powertrain malfunction.

Power Steering

Message	Action
Steering Fault Service Now	The power steering system detects a condition that requires service. See an authorized dealer.
Steering Loss Stop Safely	The power steering system is not working. Stop your vehicle in a safe place. Contact an authorized dealer.
Steering Assist Fault Service Required	The power steering system detects a condition within the power steering system or passive entry or passive start system requires service. Contact an authorized dealer.
Steering Lock Malfunction Service Now	The steering lock system detects a condition that requires service. See an authorized dealer.

Pre-Collision Assist

Message	Action
Pre-Collision Assist Not Available	The system requires service. Have the system checked as soon as possible.
Pre-Collision Assist Not Available Sensor Blocked	You have a blocked sensor due to inclement weather, ice, mud or water in front of the radar sensor. You can typically clean the sensor to resolve. If the message continues to appear, have the system checked as soon as possible.

Information Displays

Transmission

Message	Action
Shift to Park	You switched the engine off and shift select lever is in any position other than park (P).
Press Brake Pedal	Displays when the brake pedal needs to be pressed.
Transmission Over Temperature Stop Safely	The transmission is overheating and needs to cool. Stop in a safe place as soon as possible.
Transmission Service Required	See an authorized dealer.
Transmission Too Hot Press Brake	The transmission is overheating and needs to cool. Stop in a safe place as soon as possible.
Transmission Limited Function See Manual	The transmission has limited functionality. See an authorized dealer.
Transmission Not in Park	A reminder to shift into park (P). In addition, this message is typical after reconnecting or recharging the battery until you cycle the ignition to the on mode. See Changing the 12V Battery (page 124).
Transmission Fault Service Now	See an authorized dealer.
Transmission Adjusted	Displays when the transmission has adjusted the shift strategy.
Transmission Adapt-Mode	Displays when the transmission is adjusting the shift strategy.
Transmission Warming Up Please Wait	Transmission is too cold. Wait for it to warm up before you drive.
Transmission Indicat-Mode Lockup On	Displays when the transmission shift lever is locked and unable to select gears.
Transmission Indicat-Mode Lockup Off	Displays when the transmission shift lever is unlocked and free to select gears.
Transmission Overheating Stop Safely	The transmission is overheating and needs to cool. Stop in a safe place as soon as it is possible.

Starting and Stopping the Engine

GENERAL INFORMATION

WARNING: Extended idling at high engine speeds can produce very high temperatures in the engine and exhaust system, creating the risk of fire or other damage.

WARNING: Do not park, idle or drive your vehicle on dry grass or other dry ground cover. The emission system heats up the engine compartment and exhaust system, creating the risk of fire.

WARNING: Do not start the engine in a closed garage or in other enclosed areas. Exhaust fumes are toxic. Always open the garage door before you start the engine. Failure to follow this instruction could result in personal injury or death.

WARNING: Exhaust leaks may result in entry of harmful and potentially lethal fumes into the passenger compartment. If you smell exhaust fumes inside your vehicle, have your vehicle inspected immediately. Do not drive if you smell exhaust fumes.

The powertrain control system meets all Canadian interference-causing equipment standard requirements regulating the impulse electrical field or radio noise.

Note: If you use your vehicle regularly above the altitude of 5,000 ft (1,524 m) and under the temperature of -4.0°F (-20°C), it is recommended to use the alternative engine oil. See **Capacities and Specifications** (page 149).

If you disconnect the battery, your vehicle may exhibit some unusual driving characteristics for approximately 6 mi (10 km) after you reconnect it. This is because the engine management system must realign itself with the engine. You can disregard any unusual driving characteristics during this period.

When you start the engine, avoid pressing the accelerator pedal before and during operation. Only use the accelerator pedal when you have difficulty starting the engine.

IGNITION SWITCH

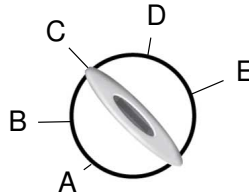

E161572

A (accessory) - Allows the electrical accessories, such as the radio, to operate while the engine is not running.

Note: Do not leave the ignition key in this position for too long. This could cause your vehicle battery to lose charge.

B (lock) - Locks the gearshift lever and allows key removal.

C (off) - The ignition is off.

Note: When you switch the ignition off and leave your vehicle, do not leave your key in the ignition. This could cause your vehicle battery to lose charge.

D (on) - All electrical circuits are operational and the warning lamps and indicators illuminate.

E (start) - Cranks the engine.

Starting and Stopping the Engine

STARTING A GASOLINE ENGINE

When you start the engine, the idle speed increases, this helps to warm up the engine. If the engine idle speed does not slow down automatically, have your vehicle checked by an authorized dealer.

Before starting the engine check the following:

- Make sure all occupants have fastened their safety belts.
- Make sure the headlamps and electrical accessories are off.
- Make sure the parking brake is on.
- Make sure the transmission is in park (P) or neutral (N).
- Turn the ignition key to the on position.

Note: Do not touch the accelerator pedal.

1. Fully press the brake pedal.
2. Turn the key to the start position to start the engine. Release the key when the engine starts.

Note: The engine may continue cranking for up to 15 seconds or until it starts.

Note: If you cannot start the engine on the first try, wait for a short period and try again.

Failure to Start

If you cannot start the engine after three attempts, wait 10 seconds and follow this procedure:

1. Fully press the brake pedal.
2. Shift into park (P).
3. Fully press the accelerator pedal and hold it there.
4. Attempt to start your vehicle and wait until the engine stops cranking.
5. Release the accelerator pedal.
6. Start the engine.

Stopping the Engine When Your Vehicle is Stationary

1. Shift into park (P) or neutral (N).
2. Turn the key to the off position.
3. Apply the parking brake.

Stopping the Engine When Your Vehicle is Moving



WARNING: Switching off the engine when your vehicle is still moving results in a significant decrease in braking assistance. Higher effort is required to apply the brakes and to stop your vehicle. A significant decrease in steering assistance could also occur. The steering does not lock, but higher effort could be required to steer your vehicle. When you switch the ignition off, some electrical circuits, for example airbags, also turn off. If you unintentionally switch the ignition off, shift into neutral (N) and restart the engine.

1. Put the transmission into neutral (N) and use the brakes to bring your vehicle to a safe stop.
2. When your vehicle has stopped, shift into park (P) or neutral (N) and switch the ignition off.
3. Apply the parking brake.

Guarding Against Exhaust Fumes



WARNING: Exhaust leaks may result in entry of harmful and potentially lethal fumes into the passenger compartment. If you smell exhaust fumes inside your vehicle, have your vehicle inspected immediately. Do not drive if you smell exhaust fumes.

Starting and Stopping the Engine

Important Ventilating Information

If you stop your vehicle and then leave the engine idling for long periods of time, we recommend that you do one of the following:

- Open the windows at least 1 in (3 cm).
- Set your climate control to outside air.

ENGINE BLOCK HEATER (IF EQUIPPED)



WARNING: Failure to follow engine block heater instructions could result in property damage or serious personal injury.



WARNING: Do not use your heater with ungrounded electrical systems or two-pronged adapters. There is a risk of electrical shock.



WARNING: Do not fully close the hood, or allow it to drop under its own weight when using the engine block heater. This could damage the power cable and may cause an electrical short resulting in fire, injury and property damage.

Note: *The engine block heater is most effective when outdoor temperatures are below 0°F (-18°C). We recommend the use of engine block heater to improve engine cold start performance.*

The heater acts as a starting aid by warming the engine coolant. This allows the climate control system to respond quickly. The equipment includes a heater element (installed in the engine block) and a wire harness. You can connect the system to a grounded 120-volt AC electrical source.

We recommend that you do the following for a safe and correct operation:

- Use a 16-gauge outdoor extension cord that is product certified by Underwriter's Laboratory (UL) or Canadian Standards Association (CSA). This extension cord must be suitable for use outdoors, in cold temperatures, and be clearly marked Suitable for Use with Outdoor Appliances. Do not use an indoor extension cord outdoors. This could result in an electric shock or become a fire hazard.
- Use as short an extension cord as possible.
- Do not use multiple extension cords.
- Make sure that when in operation, the extension cord plug and heater cord plug connections are free and clear of water. This could cause an electric shock or fire.
- Make sure your vehicle is parked in a clean area, clear of combustibles.
- Make sure the heater, heater cord and extension cord are firmly connected.
- Check for heat anywhere in the electrical hookup once the system has been operating for approximately 30 minutes.
- Make sure the system is unplugged and properly stowed before starting and driving your vehicle. Make sure the protective cover seals the prongs of the block heater cord plug when not in use.
- Make sure the heater system is checked for proper operation before winter.

Using the Engine Block Heater

Make sure the receptacle terminals are clean and dry prior to use. Clean them with a dry cloth if necessary.

Starting and Stopping the Engine

The heater uses 0.4 to 1.0 kilowatt-hours of energy per hour of use. The system does not have a thermostat. It achieves maximum temperature after approximately three hours of operation. Using the heater longer than three hours does not improve system performance and unnecessarily uses electricity.

Fuel and Refueling

SAFETY PRECAUTIONS



WARNING: Do not overfill the fuel tank. The pressure in an overfilled tank may cause leakage and lead to fuel spray and fire.



WARNING: The fuel system may be under pressure. If you hear a hissing sound near the fuel filler inlet, do not refuel until the sound stops. Otherwise, fuel may spray out, which could cause serious personal injury.



WARNING: Fuels can cause serious injury or death if misused or mishandled.



WARNING: Fuel may contain benzene, which is a cancer-causing agent.



WARNING: When refueling always shut the engine off and never allow sparks or open flames near the fuel tank filler valve. Never smoke or use a cell phone while refueling. Fuel vapor is extremely hazardous under certain conditions. Avoid inhaling excess fumes.

Follow these guidelines when refueling:

- Extinguish all smoking materials and any open flames before refueling your vehicle.
- Always switch the engine off before refueling.
- Automotive fuels can be harmful or fatal if swallowed. Fuel is highly toxic and if swallowed can cause death or permanent injury. If fuel is swallowed immediately call a physician, even if no symptoms are immediately apparent. The toxic effects of fuel may not be apparent for hours.

- Avoid inhaling fuel vapors. Inhaling fuel vapor can lead to eye and respiratory tract irritation. In severe cases, excessive or prolonged breathing of fuel vapor can cause serious illness and permanent injury.
- Avoid getting fuel in your eyes. If you splash fuel in your eyes, immediately remove contact lenses (if worn), flush with water for 15 minutes and seek medical attention. Failure to seek proper medical attention could lead to permanent injury.
- Fuels can be harmful if absorbed through the skin. If you splash fuel on your skin, clothing or both, promptly remove contaminated clothing and thoroughly wash your skin with soap and water. Repeated or prolonged skin contact causes skin irritation.
- Be particularly careful if you are taking Antabuse or other forms of Disulfiram for the treatment of alcoholism. Breathing fuel vapors could cause an adverse reaction, serious personal injury or sickness. Immediately call a physician if you experience any adverse reactions.

FUEL QUALITY

Choosing the Right Fuel

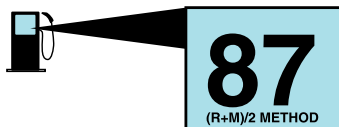

Your vehicle is designed to operate on regular unleaded gasoline with a minimum pump (R+M)/2 octane rating of 87.

Fuel and Refueling

Some fuel stations, particularly those in high altitude areas, offer fuels posted as regular unleaded gasoline with an octane rating below 87. The use of these fuels could result in engine damage that will not be covered by the vehicle warranty.

For best overall vehicle and engine performance, premium fuel with an octane rating of 91 or higher is recommended. The performance gained by using premium fuel is most noticeable in hot weather as well as other conditions, for example when towing a trailer. See **Towing** (page 83).

Do not be concerned if the engine sometimes knocks lightly. However, if the engine knocks heavily while using fuel with the recommended octane rating, contact an authorized dealer to prevent any engine damage.

We recommend Top Tier detergent gasolines, where available to help minimize engine deposits and maintain optimal vehicle and engine performance. For additional information, refer to www.toptiergas.com.

Note: *Use of any fuel for which the vehicle was not designed can impair the emission control system, cause loss of vehicle performance, and cause damage to the engine which may not be covered by the vehicle Warranty.*

Do not use:

- Diesel fuel.
- Fuels containing kerosene or paraffin.
- Fuel containing more than 15% ethanol or E85 fuel.
- Fuels containing methanol.
- Fuels containing metallic-based additives, including manganese-based compounds.

- Fuels containing the octane booster additive, methylcyclopentadienyl manganese tricarbonyl (MMT).
- Leaded fuel, using leaded fuel is prohibited by law.

The use of fuels with metallic compounds such as methylcyclopentadienyl manganese tricarbonyl (commonly known as MMT), which is a manganese-based fuel additive, will impair engine performance and affect the emission control system.

RUNNING OUT OF FUEL



WARNING: Flow of fuel through a fuel pump nozzle can produce static electricity. This can cause a fire if you are filling an ungrounded fuel container.

Avoid running out of fuel because this situation may have an adverse effect on engine components.

If you have run out of fuel:

- You may need to cycle the ignition from off to on several times after refueling to allow the fuel system to pump the fuel from the tank to the engine. On restarting, cranking time will take a few seconds longer than normal. With keyless ignition, just start the engine. Crank time will be longer than usual.
- Normally, adding 1 gal (4 L) of fuel is enough to restart the engine. If the vehicle is out of fuel and on a steep grade, more than 1 gal (4 L) may be required.

Fuel and Refueling

REFUELING



WARNING: Do not overfill the fuel tank. The pressure in an overfilled tank may cause leakage and lead to fuel spray and fire.



WARNING: Do not remove the fuel pump nozzle from its fully inserted position when refueling.



WARNING: When refueling always shut the engine off and never allow sparks or open flames near the fuel tank filler valve. Never smoke or use a cell phone while refueling. Fuel vapor is extremely hazardous under certain conditions. Avoid inhaling excess fumes.



WARNING: Wait at least five seconds before removing the fuel pump nozzle to allow any residual fuel to drain into the fuel tank.



WARNING: Stop refueling when the fuel pump nozzle automatically shuts off for the first time. Failure to follow this will fill the expansion space in the fuel tank and could lead to fuel overflowing.

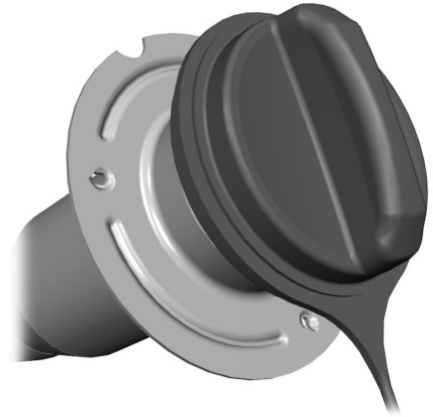

1. Remove the fuel filler cap.

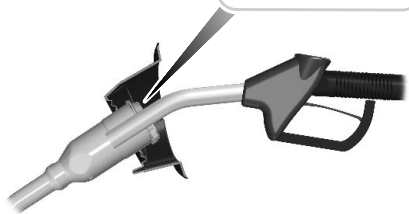
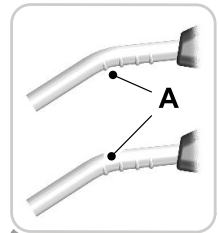

2. Insert the fuel pump nozzle up to the first notch on the nozzle A. Keep it resting on the cover of the fuel tank filler pipe opening.

Fuel and Refueling

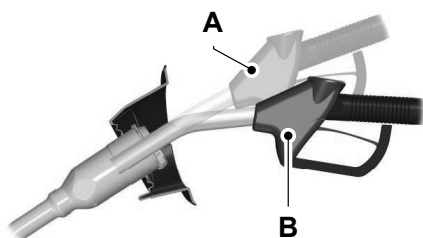

3. Hold the fuel pump nozzle in the lower position B when refueling. Holding the fuel pump nozzle in the higher position A may affect the flow of fuel and shut off the fuel pump nozzle before the fuel tank is full.

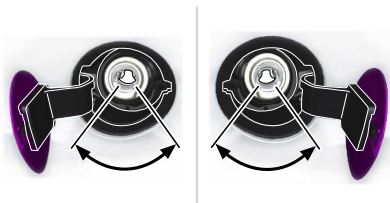

4. Operate the fuel pump nozzle within the area shown.

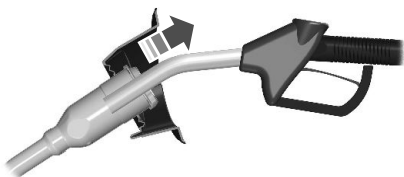

5. When the nozzle shuts off, wait at least 5 seconds, then slightly raise the fuel pump nozzle and slowly remove it.
6. Install the fuel filler cap by rotating it clockwise until it clicks.

Note: Do not attempt to start the engine if you have filled the fuel tank with incorrect fuel. Incorrect fuel use can cause damage and could void the vehicle Warranty. Have your vehicle checked immediately.

FUEL CONSUMPTION

Advertised Capacity

The advertised capacity is the maximum amount of fuel that you can add to the fuel tank after running out of fuel. Included in the advertised capacity is an empty reserve. The empty reserve is an unspecified amount of fuel that remains in the fuel tank when the fuel gauge indicates empty.

Note: The amount of fuel in the empty reserve varies and should not be relied upon to increase driving range.

Fuel Economy

Your vehicle calculates fuel economy figures through the trip computer average fuel function. See **General Information** (page 30).

The first 1,000 mi (1,500 km) of driving is the break-in period of the engine. A more accurate measurement is obtained after 2,000 mi (3,000 km).

Impacting Fuel Economy

- Incorrect tire inflation pressures.
- Fully loading your vehicle.
- Carrying unnecessary weight.
- Adding certain accessories to your vehicle such as bug deflectors, rollbars or light bars, running boards and ski racks.
- Using fuel blended with alcohol. See **Fuel Quality** (page 42).
- Fuel economy may decrease with lower temperatures.

Fuel and Refueling

- Fuel economy may decrease when driving short distances.
- You may get better fuel economy when driving on flat terrain than when driving on hilly terrain.

Engine Emission Control

EMISSION LAW



WARNING: Do not remove or alter the original equipment floor covering or insulation between it and the metal floor of the vehicle. The floor covering and insulation protect occupants of the vehicle from the engine and exhaust system heat and noise. On vehicles with no original equipment floor covering insulation, do not carry passengers in a manner that permits prolonged skin contact with the metal floor. Failure to follow these instructions may result in fire or personal injury.

U.S. federal laws and certain state laws prohibit removing or rendering inoperative emission control system components. Similar federal or provincial laws may apply in Canada. We do not approve of any vehicle modification without first determining applicable laws.



Tampering with emissions control systems including related sensors or the Diesel Exhaust Fluid system can result in reduced engine power and the illumination of the service engine soon light.

Tampering With a Noise Control System

Federal laws prohibit the following acts:

- Removal or rendering inoperative by any person other than for purposes of maintenance.
- Repair or replacement of any device or element of the design incorporated into a new vehicle for the purpose of noise control prior to its sale or delivery to the ultimate purchaser or while it is in use.
- The use of the vehicle after any person removes or renders inoperative any device or element of the design.

The U.S. Environmental Protection Agency may presume to constitute tampering as follows:

- Removal of hood blanket, fender apron absorbers, fender apron barriers, underbody noise shields or acoustically absorptive material.
- Tampering or rendering inoperative the engine speed governor, to allow engine speed to exceed manufacturer specifications.

If the engine does not start, runs rough, experiences a decrease in engine performance, experiences excess fuel consumption or produces excessive exhaust smoke, check for the following:

- A plugged or disconnected air inlet system hose.
- A plugged engine air filter element.
- Water in the fuel filter and water separator.
- A clogged fuel filter.
- Contaminated fuel.
- Air in the fuel system, due to loose connections.
- An open or pinched sensor hose.
- Incorrect engine oil level.

Engine Emission Control

- Incorrect fuel for climatic conditions.
- Incorrect engine oil viscosity for climactic conditions.

Note: *Some vehicles have a lifetime fuel filter that is integrated with the fuel tank. Regular maintenance or replacement is not needed.*

Note: *If these checks do not help you correct the concern, have your vehicle checked as soon as possible.*

Noise Emissions Warranty, Prohibited Tampering Acts and Maintenance

On January 1, 1978, Federal regulation became effective governing the noise emission on trucks over 10,000 lb (4,536 kg) Gross Vehicle Weight Rating (GVWR). The preceding statements concerning prohibited tampering acts and maintenance, and the noise warranty found in the Warranty Guide, are applicable to complete chassis cabs over 10,000 lb (4,536 kg) GVWR.

CATALYTIC CONVERTER



WARNING: Do not park, idle or drive your vehicle on dry grass or other dry ground cover. The emission system heats up the engine compartment and exhaust system, creating the risk of fire.



WARNING: The normal operating temperature of the exhaust system is very high. Never work around or attempt to repair any part of the exhaust system until it has cooled. Use special care when working around the catalytic converter. The catalytic converter heats up to a very high temperature after only a short period of engine operation and stays hot after the engine is switched off.



WARNING: Exhaust leaks may result in entry of harmful and potentially lethal fumes into the passenger compartment. If you smell exhaust fumes inside your vehicle, have your vehicle inspected immediately. Do not drive if you smell exhaust fumes.

Your vehicle has various emission control components and a catalytic converter that enables it to comply with applicable exhaust emission standards.

To make sure that the catalytic converter and other emission control components continue to work properly:

- Do not crank the engine for more than 10 seconds at a time.
- Do not run the engine with a spark plug lead disconnected.
- Do not push-start or tow-start your vehicle. Use booster cables. See **Jump Starting the Vehicle** (page 90).
- Use only the specified fuel listed.
- Do not switch the ignition off when your vehicle is moving.
- Avoid running out of fuel.
- Have the items listed in scheduled maintenance information performed according to the specified schedule.

Note: *Your vehicle warranty does not cover resulting component damage.*

The scheduled maintenance items listed in scheduled maintenance information are essential to the life and performance of your vehicle and to its emissions system.

If you use anything other than our parts for maintenance replacements or for service of components affecting emission control, such aftermarket parts should be equivalent to our genuine parts in performance and durability.

Engine Emission Control

Illumination of the service engine soon indicator, charging system warning light or the temperature warning light, fluid leaks, strange odors, smoke or loss of engine power could indicate that the emission control system is not working properly.

An improperly operating or damaged exhaust system may allow exhaust to enter the vehicle. Have a damaged or improperly operating exhaust system inspected and repaired immediately.

Do not make any unauthorized changes to your vehicle or engine. By law, vehicle owners and anyone who manufactures, repairs, services, sells, leases, trades vehicles, or supervises a fleet of vehicles are not permitted to intentionally remove an emission control device or prevent it from working. Information about your vehicle's emission system is on the Vehicle Emission Control Information Decal located on or near the engine. This decal also lists engine displacement.

Please consult your warranty information for complete details.

On-Board Diagnostics (OBD-II)

Your vehicle has a computer known as the on-board diagnostics system (OBD-II) that monitors the engine's emission control system. The system protects the environment by making sure that your vehicle continues to meet government emission standards. The OBD-II system also assists a service technician in properly servicing your vehicle.



When the service engine soon indicator illuminates, the OBD-II system has detected a malfunction. Temporary malfunctions may cause the service engine soon indicator to illuminate. Examples are:

1. Your vehicle has run out of fuel—the engine may misfire or run poorly.
2. Poor fuel quality or water in the fuel—the engine may misfire or run poorly.
3. The fuel fill inlet may not have closed properly. See **Refueling** (page 44).
4. Driving through deep water—the electrical system may be wet.

You can correct these temporary malfunctions by filling the fuel tank with good quality fuel, properly closing the fuel fill inlet or letting the electrical system dry out. After three driving cycles without these or any other temporary malfunctions present, the service engine soon indicator should stay off the next time you start the engine. A driving cycle consists of a cold engine startup followed by mixed city and highway driving. You do not require additional vehicle service.

If the service engine soon indicator remains on, have your vehicle serviced at the first available opportunity. Although some malfunctions detected by the OBD-II may not have symptoms that are apparent, continued driving with the service engine soon indicator on can result in increased emissions, lower fuel economy, reduced engine and transmission smoothness and lead to more costly repairs.

Readiness for Inspection and Maintenance (I/M) Testing

Some state and provincial and local governments may have Inspection/Maintenance (I/M) programs to inspect the emission control equipment on your vehicle. Failure to pass this inspection could prevent you from getting a vehicle registration.



If the service engine soon indicator is on or the bulb does not work, your vehicle may need service. See On-Board Diagnostics.

Engine Emission Control

Your vehicle may not pass the I/M test if the service engine soon indicator is on or not working properly, for example, the bulb does not work, or if the OBD-II system has determined that some of the emission control systems have not been properly checked. In this case, the vehicle is not ready for I/M testing.

If you have just serviced the vehicle's engine or transmission or the battery has recently run down or you have replaced it, the OBD-II system may indicate that the vehicle is not ready for I/M testing. To determine if the vehicle is ready for I/M testing, turn the ignition key to the on position for 15 seconds without cranking the engine. If the service engine soon indicator blinks eight times, it means that the vehicle is not ready for I/M testing; if the service engine soon indicator stays on solid, it means that your vehicle is ready for I/M testing.

The OBD-II system checks the emission control system during normal driving. A complete check may take several days.

If the vehicle is not ready for I/M testing, you can perform the following driving cycle consisting of mixed city and highway driving:

1. 15 minutes of steady driving on an expressway or highway followed by 20 minutes of stop-and-go driving with at least four 30-second idle periods.
2. Allow your vehicle to sit for at least eight hours with the ignition off. Then, start the vehicle and complete the above driving cycle. The vehicle must warm up to its normal operating temperature. Once started, do not turn off the vehicle until the above driving cycle is complete.

If the vehicle is still not ready for I/M testing, you need to repeat the above driving cycle.

Transmission

AUTOMATIC TRANSMISSION



WARNING: Apply the parking brake, shift into park (P), switch the ignition off and remove the key before you leave your vehicle. Failure to follow this instruction could result in personal injury or death.



WARNING: Do not apply the brake pedal and accelerator pedal simultaneously. Applying both pedals simultaneously for more than a few seconds limits vehicle performance, which may result in difficulty maintaining speed in traffic and could lead to serious injury.

Understanding the Positions of Your Automatic Transmission

P R N D M 2 1

P R N D 4 2 1

Selecting a Transmission Position

1. Fully press down the brake pedal.
2. Move the gearshift lever into the preferred gear.

3. When you are done driving, come to a complete stop.
4. Move the gearshift lever and securely latch it in park (P).

The instrument cluster displays the current gear.

Park (P)

This position locks the transmission and prevents the wheels from turning.

Reverse (R)

With the gearshift lever in reverse (R), your vehicle moves backward. Always come to a complete stop before shifting into and out of reverse (R).

Neutral (N)

With the gearshift lever in neutral (N), your vehicle can be started and is free to roll. Hold the brake pedal down when in this position.

Drive (D)

Drive (D) is the normal driving position for the best fuel economy. The overdrive function allows automatic upshifts through all available gears.

Manual (M)

With the gearshift lever in manual (M), the driver can change gears up or down as preferred. By moving the gearshift lever from drive (D) to manual (M), you now have control of selecting the gear you prefer using buttons on the shift lever.

To return to normal drive (D) position, move the shift lever back from manual (M) to drive (D).

The transmission operates in gears one through six.

Transmission

Fourth (4)

The transmission operates in fourth (4) gear only. Use fourth (4) gear for improved traction on slippery roads.

Second (2)

The transmission operates in second (2) gear only. Use second (2) gear to start-up on slippery roads.

First (1)

- The transmission operates in first (1) gear only.
- Provides maximum engine braking.
- Allows upshifts by moving the gearshift lever.
- Does not downshift into first (1) gear at high speeds. Allows for first (1) gear when the vehicle reaches slower speeds.

Tow/Haul Mode



WARNING: Do not use tow/haul when the road surface is slippery. Failure to follow this instruction could result in the loss of control of your vehicle.



To activate tow/haul, press the button on the gearshift lever once. The TOW HAUL indicator light illuminates in the instrument cluster.

To deactivate the tow/haul feature and return to normal driving mode, press the button on the gearshift lever again. The TOW HAUL light deactivates. Tow/haul can also deactivate when you power down your vehicle.

The tow/haul feature:

- Delays upshifts to reduce the frequency of transmission shifting.
- Provides engine braking in all forward gears, which can slow your vehicle and assist you in controlling your vehicle when descending a slope.
- Depending on driving conditions and load conditions, may downshift the transmission, slow your vehicle and control your vehicle speed when descending a hill, without pressing the accelerator pedal. The amount of downshift braking provided varies based on the amount the brake pedal is pressed.

The tow/haul feature improves transmission operation when towing a trailer or a heavy load. All transmission gear ranges are available when using tow/haul.

Forced Downshifts

To achieve a forced downshift, press the accelerator pedal to the floor to allow the forced downshift.

- Allowed in drive (D) with the tow/haul feature on or off.
- Allows transmission to select an appropriate gear.

Transmission

Progressive Range Selection (PRS) (If Equipped)

This feature gives you the ability to lockout gears from the automatic shifting range. This may provide you with an improved driving experience, for example, in slippery conditions, or when experiencing a steep slope.

With the gearshift lever in drive (D), press the – button to activate PRS. The instrument cluster indicates the available and selected gears.

Press the – button again to lock out gears beginning with the highest gear. Only the available gears display, and the transmission automatically shifts between the available gears. Press the + button to unlock gears to allow the transmission to shift to higher gears. The transmission shifts within the gear range you select.

Automatic Transmission Adaptive Learning

This feature may increase durability and provide consistent shift feel over the life of your vehicle. A new vehicle or transmission may have firm shifts, soft shifts, or both. This is normal and does not affect function or durability of the transmission. Over time, the adaptive learning process fully updates transmission operation.

Brake-Shift Interlock



WARNING: Do not drive your vehicle until you verify that the stoplamps are working.



WARNING: When doing this procedure, you need to take the transmission out of park (P) which means your vehicle can roll freely. To avoid unwanted vehicle movement, apply the parking brake prior to doing this procedure. Use wheel chocks if appropriate.



WARNING: If the parking brake is fully released, but the brake warning lamp remains illuminated, the brakes may not be working properly. Have your vehicle checked as soon as possible.

Your vehicle has a feature that prevents the gearshift lever from moving from park (P) when the ignition is in the on position and the brake pedal is not pressed.

If you cannot move the gearshift lever out of the park (P) position with the ignition in the on position and the brake pedal pressed, a malfunction may have occurred. It is possible that a fuse has blown, or your vehicle's brake lamps are not operating properly. See **Fuse Specification Chart** (page 101).

If the fuse is not blown and the brake lamps are working properly, the following procedure allows you to move the gearshift lever from park (P):

1. Apply the parking brake. Switch the ignition key to off, then remove the key.
2. Move the steering column to the full down and full rearward position, toward the driver seat.
3. Remove the gearshift lever boot.

Transmission

- Place your fingers into the hole where you removed the gearshift lever boot and pull the top half of the shroud up and forward to separate it from the lower half of the shroud. There is a hinge at the forward edge of the top of the shroud. Roll the top half of the shroud upward on the hinge point, then pull straight rearward toward the driver seat to remove.
- Remove the top half of the shroud.
- Remove the three fasteners under the column that secure the lower shroud half to the column.

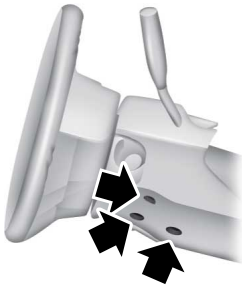

- Pull the lock lever into the full unlocked position and remove the lower shroud cover by pulling the lever handle through the slot in the cover.
- Apply the brake. Gently lift the override disk and move the gearshift lever into neutral (N).

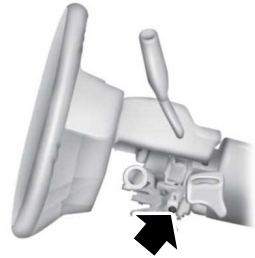

- Start your vehicle.

Perform Steps 4 through 8 in reverse order, making sure to engage the hinge pivots between the upper and lower halves of the shroud. Keep slight pressure in the forward direction as you rotate the halves together.

If Your Vehicle Gets Stuck in Mud or Snow

If your vehicle gets stuck in mud or snow, you may rock it out by shifting between forward and reverse gears, stopping between shifts in a steady pattern. Press lightly on the accelerator in each gear.

Note: Do not rock your vehicle if the engine is not at normal operating temperature or damage to the transmission could occur.

Note: Do not rock your vehicle for more than a minute or damage to the transmission and tires may occur, or the engine could overheat.

Brakes

GENERAL INFORMATION

Note: Occasional brake noise is normal. If a metal-to-metal, continuous grinding or continuous squeal sound is present, the brake linings may be worn-out, have the system checked. If the vehicle has continuous vibration or shudder in the steering wheel while braking, have the system checked as soon as possible.

Note: Brake dust may accumulate on the wheels, even under normal driving conditions. Some dust is inevitable as the brakes wear and does not contribute to brake noise. See **Cleaning the Wheels** (page 128).

BRAKE See **Warning Lamps and Indicators** (page 27).



Wet brakes result in reduced braking efficiency. Gently press the brake pedal a few times when driving from a car wash or standing water to dry the brakes.

Brake Over Accelerator

In the event the accelerator pedal becomes stuck or entrapped, apply steady and firm pressure to the brake pedal to slow the vehicle and reduce engine power. If you experience this condition, apply the brakes and bring your vehicle to a safe stop. Move the transmission to park (P), switch the engine off and apply the parking brake. Inspect the accelerator pedal for any interference. If none are found and the condition persists, have the system checked.

Anti-lock Brake System

This system helps you maintain steering control during emergency stops by keeping the brakes from locking.



If it illuminates when you are driving, your vehicle requires service. Your vehicle continues to have normal braking without the anti-lock brake system function. Have your vehicle checked as soon as possible.

It also momentarily illuminates when you switch the ignition on to confirm the lamp is functional. If it does not illuminate when you switch the ignition on, or begins to flash at any time, have the system checked.



It illuminates when you engage the parking brake and the ignition is on.



If it illuminates when your vehicle is moving, make sure the parking brake is disengaged. If the parking brake is disengaged, this indicates low brake fluid level or a brake system fault. Have your vehicle checked as soon as possible.

It also momentarily illuminates when you switch the ignition on to confirm the lamp is functional. If it does not illuminate when you switch the ignition on, or begins to flash at any time, have the system checked.

Hydraulic brake booster system (Hydroboost or Hydromax)

The Hydroboost and Hydromax systems receive fluid pressure from the power steering pump to provide power assist during braking.

The Hydromax booster receives backup pressure from the reserve system electric pump whenever the fluid in the power steering system is not flowing. When the engine is off, the pump turns on if you apply the brake pedal, or if you switch the ignition to the on position.

Brakes

The sound of the pump operating may be heard by the driver. This is a normal characteristic of the system.

The reserve system provides reduced braking power, so the vehicle should be operated under these conditions with caution, and only to seek service repair and removal of the vehicle from the roadway.

Note: *For vehicles with the Hydromax system operating under normal conditions, the noise of the fluid flowing through the booster may be heard whenever you apply the brake. This condition is normal. Vehicle service is not required.*

If braking performance or pedal response becomes very poor, even when you strongly press the pedal, it may indicate the presence of air in the hydraulic system or leakage of fluid. Stop your vehicle as soon as it is safe to do so. Have the system checked as soon as possible.

HINTS ON DRIVING WITH ANTI-LOCK BRAKES

The anti-lock brake system does not eliminate the risks when:

- You drive too closely to the vehicle in front of you.
- Your vehicle is hydroplaning.
- You take corners too fast.
- The road surface is poor.

Note: *If the system activates, the brake pedal could pulse and may travel further. Maintain pressure on the brake pedal. You may also hear a noise from the system. This is normal.*

PARKING BRAKE



WARNING: Apply the parking brake, shift into park (P), switch the ignition off and remove the key before you leave your vehicle. Failure to follow this instruction could result in personal injury or death.

Apply the parking brake whenever you park your vehicle.

- For vehicles with a foot operated parking brake, press the pedal down.
- For vehicles with a hand operated parking brake, pull the parking brake lever up.



It illuminates when you switch the ignition on and apply the parking brake. It also illuminates momentarily when you switch the ignition on to confirm the lamp is functional. If it does not illuminate when you switch the ignition on or begins to flash at any time, have the system checked by an authorized dealer.

If it illuminates when your vehicle is moving, make sure you disengage the parking brake.

If the parking brake is disengaged, this indicates a low brake fluid level or a brake system fault. Have your vehicle checked as soon as possible.

To release the parking brake:

- For vehicles with a foot operated parking brake, pull the parking brake release lever.
- For vehicles with a hand operated parking brake, push the parking brake lever down.

Brakes

HILL START ASSIST (IF EQUIPPED)



WARNING: The system does not replace the parking brake. When you leave your vehicle, always apply the parking brake.



WARNING: You must remain in your vehicle when the system turns on. At all times, you are responsible for controlling your vehicle, supervising the system and intervening, if required. Failure to take care may result in the loss of control of your vehicle, serious personal injury or death.



WARNING: The system will turn off if a malfunction is apparent or if you rev the engine excessively. Failure to take care may result in the loss of control of your vehicle, serious personal injury or death.

The system makes it easier to pull away when your vehicle is on a slope without the need to use the parking brake.

When the system is active, your vehicle remains stationary on the slope for two to three seconds after you release the brake pedal. This allows time to move your foot from the brake to the accelerator pedal. The system releases the brakes automatically once the engine has developed sufficient torque to prevent your vehicle from rolling down the slope. This is an advantage when pulling away on a slope, for example from a car park ramp, traffic lights or when reversing uphill into a parking space.

The system activates on any slope that causes your vehicle to roll.

Note: *There is no warning light to indicate the system is either on or off.*

Using Hill Start Assist

1. Press the brake pedal to bring your vehicle to a complete standstill. Keep the brake pedal pressed and shift into first gear when facing uphill or reverse (R) when facing downhill.
2. If the sensors detect that your vehicle is on a slope, the system activates automatically.
3. When you remove your foot from the brake pedal, your vehicle remains on the slope without rolling away for about two to three seconds. This hold time automatically extends if you are in the process of driving off.
4. Drive off in the normal manner. The system releases the brakes automatically.

Note: *When you remove your foot from the brake pedal and press the pedal again when the system is active, you will experience significantly reduced brake pedal travel. This is normal.*

Switching the System On and Off

Vehicles with Manual Transmission

You can switch this feature on or off in the information display. The system remembers the last setting when you start your vehicle.

Vehicles with Automatic Transmission

You cannot turn the system on or off. When you switch the ignition on, the system automatically turns on.

Traction Control

PRINCIPLE OF OPERATION

The traction control system helps avoid drive wheel spin and loss of traction.

If your vehicle begins to slide, the system applies the brakes to individual wheels and, when needed, reduces engine power at the same time. If the wheels spin when accelerating on slippery or loose surfaces, the system reduces engine power in order to increase traction.

When the system turns the traction control off, the OFF light illuminates on the instrument cluster. If a traction event occurs in either mode, the stability and traction control light rapidly flashes.

USING TRACTION CONTROL



WARNING: Operating your vehicle with the traction control disabled could lead to an increased risk of loss of vehicle control, vehicle rollover, personal injury and death.

The system turns on each time you switch the ignition on.

TCS OFF

Use the traction control button on the instrument panel to switch the system off or on.

If your vehicle is stuck in mud or snow, switching traction control off is beneficial as this allows the wheels to spin.

Press the button again to switch the traction control system on.

System Indicator Light

Note: *If the traction control light does not flash during a traction control event or stays on, the system is not operating. Have the system checked as soon as possible.*

During a traction control event, the traction control light rapidly flashes. Pressing further on the accelerator does not cause the engine to rev higher. This is normal and is no reason for concern.

Stability Control

PRINCIPLE OF OPERATION



WARNING: Vehicle modifications involving braking system, aftermarket roof racks, suspension, steering system, tire construction and wheel and tire size may change the handling characteristics of your vehicle and may adversely affect the performance of the electronic stability control system. In addition, installing any stereo loudspeakers may interfere with and adversely affect the electronic stability control system. Install any aftermarket stereo loudspeaker as far as possible from the front center console, the tunnel, and the front seats in order to minimize the risk of interfering with the electronic stability control sensors. Reducing the effectiveness of the electronic stability control system could lead to an increased risk of loss of vehicle control, vehicle rollover, personal injury and death.



WARNING: Remember that even advanced technology cannot defy the laws of physics. It's always possible to lose control of a vehicle due to inappropriate driver input for the conditions. Aggressive driving on any road condition can cause you to lose control of your vehicle increasing the risk of personal injury or property damage. Activation of the electronic stability control system is an indication that at least some of the tires have exceeded their ability to grip the road; this could reduce the operator's ability to control the vehicle potentially resulting in a loss of vehicle control, vehicle rollover, personal injury and death. If your electronic stability control system activates, SLOW DOWN.

The system turns on each time you switch the ignition on.

If a fault occurs in either the stability control or the traction control system, the following conditions are possible:

- The stability and traction control light illuminate.
- The stability control and traction control systems are not maintaining traction of the wheels.

If a driving condition activates either the stability control or the traction control system, the following conditions are possible:

- The stability and traction control light flash.
- Your vehicle slows down.
- The system reduces engine power.
- A vibration in the brake pedal.
- The brake pedal is stiffer than usual.
- If the driving condition is severe and your foot is not on the brake, the brake pedal could move as the system applies higher brake force.

The stability control system has several features built into it to help you maintain control of your vehicle:

Electronic Stability Control

The system assists in preventing skids or lateral slides by applying the brakes to one or more of the wheels individually and, if necessary, decreases engine power.

Traction Control

The system helps maintain traction of the wheels by detecting and controlling wheel spin. See **Using Traction Control** (page 58).

Stability Control

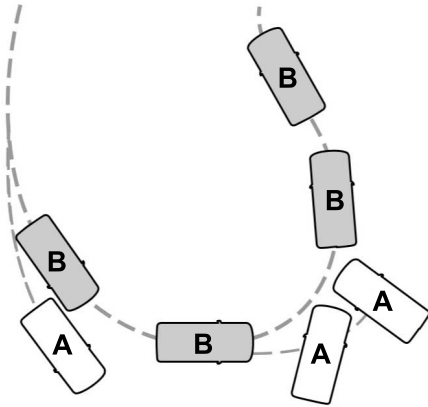

- A Vehicle without stability control skidding off its intended route.
- B Vehicle with stability control maintaining control on a slippery surface.

Cruise Control (If Equipped)

WHAT IS CRUISE CONTROL

Cruise control lets you maintain a set speed without keeping your foot on the accelerator pedal.

Requirements

Use cruise control when the vehicle speed is greater than 20 mph (30 km/h).

SWITCHING CRUISE CONTROL ON AND OFF



WARNING: Do not use cruise control on winding roads, in heavy traffic or when the road surface is slippery. This could result in loss of vehicle control, serious injury or death.

The cruise controls are on the steering wheel. See **Cruise Control** (page 16).

Switching Cruise Control On

ON

Press the button.

Switching Cruise Control Off

OFF

Press the button when the system is in standby mode.

The system also turns off when you switch the ignition off.

Note: *The set speed erases when you switch the system off.*

SETTING THE CRUISE CONTROL SPEED



WARNING: When you are going downhill, your vehicle speed could increase above the set speed. The system does not apply the brakes.

Drive to the speed you prefer.

SET+

Press either button to set the current speed.

SET-

Take your foot off the accelerator pedal.

Note: *The indicator changes color in the information display.*

Changing the Set Speed

SET+

Press and release the button to increase the set speed in small increments.

Press and hold the button to accelerate. Release the button when you reach your preferred speed.

SET-

Press and release the button to decrease the set speed in small increments.

Press and hold the button to decelerate. Release the button when you reach your preferred speed.

Note: *If you accelerate by pressing the accelerator pedal, the set speed does not change. When you release the accelerator pedal, your vehicle returns to the speed that you previously set.*

Cruise Control (If Equipped)

CANCELING THE SET SPEED

CNCL Press the button, or tap the brake pedal to cancel the set speed.

Note: *The system remembers the set speed.*

Note: *The system cancels if the vehicle speed drops below 10 mph (16 km/h) under the set speed when driving uphill.*

RESUMING THE SET SPEED

RES Press the button.

CRUISE CONTROL INDICATORS

 Illuminates when you switch the system on.

USING ADAPTIVE CRUISE CONTROL (IF EQUIPPED)

 **WARNING:** You are responsible for controlling your vehicle at all times. The system is designed to be an aid and does not relieve you of your responsibility to drive with due care and attention. Failure to follow this instruction could result in the loss of control of your vehicle, personal injury or death.

 **WARNING:** Do not use adaptive cruise control on winding roads, in heavy traffic or when the road surface is slippery. This could result in loss of vehicle control, serious injury or death.

 **WARNING:** Pay close attention to changing road conditions such as entering or leaving a highway, on roads with intersections or roundabouts, roads without visible lanes of travel, roads that are unpaved, or steep slopes. Failure to follow this instruction could result in the loss of control of your vehicle, personal injury or death.

 **WARNING:** In situations with poor visibility, such as fog, heavy rain or other inclement weather, you may need to override or completely switch off the system.

 **WARNING:** Do not use the system when towing a trailer that has aftermarket electronic trailer brake controls. Failure to follow this instruction could result in the loss of control of your vehicle, personal injury or death.

 **WARNING:** Do not use tire sizes other than those recommended because this can affect the normal operation of the system. Failure to do so may result in a loss of vehicle control, which could result in serious injury.

 **WARNING:** The system may not detect stationary or slow moving vehicles below 6 mph (10 km/h).

 **WARNING:** The system does not detect pedestrians or objects in the road.

 **WARNING:** The system does not detect oncoming vehicles in the same lane.

 **WARNING:** The system is not a crash warning or avoidance system.

Cruise Control (If Equipped)

The system adjusts your vehicle speed to maintain the set gap between you and the vehicle in front of you in the same lane. You can select four gap settings.

The system uses a radar sensor that projects a beam directly in front of your vehicle.



E262918

The adaptive cruise controls are on the steering wheel.

Switching Adaptive Cruise Control On

ON

Press and release the button.



The indicator, current gap setting and set speed appear in the information display.

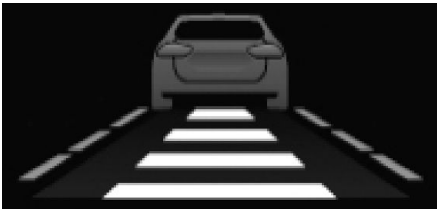

Setting the Adaptive Cruise Speed

Drive to your preferred speed.

SET+

SET-

Press and release either button.

Take your foot off the accelerator pedal.

The indicator, current gap setting and set speed appear in the information display.

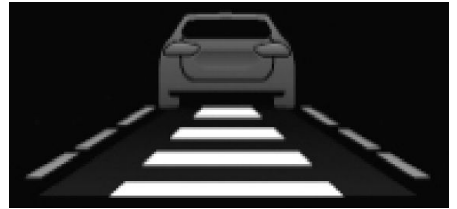

A vehicle graphic illuminates if there is a vehicle detected in front of you.

Note: When adaptive cruise control is active, the speedometer may vary slightly from the set speed displayed in the information display.

Following a Vehicle



WARNING: When following a vehicle that is braking, your vehicle does not always decelerate quickly enough to avoid a crash without driver intervention. Apply the brakes when necessary. Failure to follow this instruction could result in personal injury or death.

Cruise Control (If Equipped)



WARNING: The system only warns of vehicles detected by the radar sensor. In some cases there may be no warning or a delayed warning. Apply the brakes when necessary. Failure to follow this instruction could result in personal injury or death.

Note: When you are following a vehicle and you switch on a direction indicator, adaptive cruise control may provide a small temporary acceleration to help you pass.

Note: The brakes may emit noise when applied by the system.

When a vehicle ahead of you enters the same lane or a slower vehicle is ahead in the same lane, the vehicle speed adjusts to maintain a preset gap distance. A vehicle graphic illuminates in the instrument cluster.

Your vehicle maintains a consistent gap from the vehicle ahead until any of the following occur:

- The vehicle in front of you accelerates to a speed above the set speed.
- The vehicle in front of you moves out of the lane you are in.
- Your vehicle speed falls below 12 mph (20 km/h).
- You set a new gap distance.

The system applies the brakes to slow your vehicle to maintain a safe gap distance from the vehicle in front. The system only applies limited braking. You can override the system by applying the brakes.

If the system determines that its maximum braking level is not sufficient, an audible warning sounds, a message appears in the information display and an indicator flashes when the system continues to brake. Take immediate action.

Setting the Gap Distance

You can decrease or increase the distance between your vehicle and the vehicle in front by pressing the gap control.



Press and release to decrease the gap distance.



Press and release to increase the gap distance.



The selected gap appears in the information display as shown by the bars in the image.

Note: The gap setting is time dependent and therefore the distance adjusts with your vehicle speed.

Note: It is your responsibility to select a gap appropriate to the driving conditions.

Cruise Control (If Equipped)

Adaptive Cruise Control Gap Settings

Graphic Display, Bars Indicated Between Vehicles	Distance Gap	Dynamic Behavior
1	Closest.	Sport.
2	Close.	Normal.
3	Medium.	Normal.
4	Far.	Comfort.

Each time you switch the system on, it selects the last chosen gap setting.

Overriding the Set Speed



WARNING: If you override the system by pressing the accelerator pedal, it does not automatically apply the brakes to maintain a gap from any vehicle ahead.

When you press the accelerator pedal, you override the set speed and gap distance.



Use the accelerator pedal normally to intentionally exceed the set speed limit.

When you override the system, the green indicator light illuminates and the vehicle image does not appear in the information display.

The system resumes operation when you release the accelerator pedal. The vehicle speed decreases to the set speed, or a lower speed if following a slower vehicle.

Changing the Set Speed



Press and release to increase the set speed in small increments.



Press and release to decrease the set speed in small increments.

Press and hold either button to change the set speed in large increments. Release the button when the set speed has reached the desired speed.

The system may apply the brakes to slow the vehicle to the new set speed. The set speed displays continuously in the information display when the system is active.

Canceling the Set Speed



Press and release the button or tap the brake pedal.

The set speed does not erase.

Resuming the Set Speed



Press and release the button.

Your vehicle speed returns to the previously set speed and gap setting. The set speed displays continuously in the information display when the system is active.

Note: Only use resume if you are aware of the set speed and intend to return to it.

Automatic Cancellation

The system is not functional at vehicle speeds below 12 mph (20 km/h). An audible alarm sounds and the automatic braking releases if the vehicle drops below this speed.

Automatic cancellation can occur when the tires lose traction or you apply the parking brake.

Cruise Control (If Equipped)

Hilly Condition and Trailer Tow Usage

You should select a lower gear when the system is active in situations such as prolonged downhill driving on steep grades, for example in mountainous areas. The system needs additional engine braking in these situations to reduce the load on the vehicle's regular brake system to prevent it from overheating.

Note: An audible alarm sounds and the system shuts down if it applies the brakes for an extended period of time. This allows the brakes to cool. The system functions normally again after the brakes cool.

Note: When towing with adaptive cruise control, switch on Tow/Haul Mode.

Switching Adaptive Cruise Control Off

OFF

Press and release the button when the system is in standby mode, or switch the ignition off.

Note: The set speed is erased when you switch the system off.

Detection Issues



WARNING: On rare occasions, detection issues can occur due to the road infrastructures, for example bridges, tunnels and safety barriers. In these cases, the system may brake late or unexpectedly. At all times, you are responsible for controlling your vehicle, supervising the system and intervening, if required.



WARNING: If the system malfunctions, have your vehicle checked as soon as possible.

The radar sensor has a limited field of view. It may not detect vehicles at all or detect a vehicle later than expected in some situations. The lead vehicle graphic does not illuminate if the system does not detect a vehicle in front of you.

A

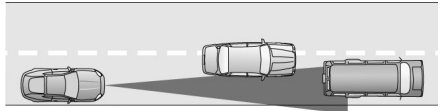

B

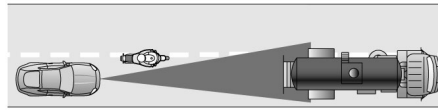

C

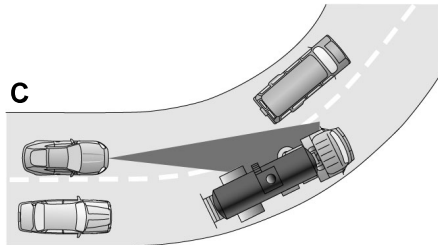

Detection issues can occur:

- A When driving on a different line than the vehicle in front.
- B With vehicles that edge into your lane. The system can only detect these vehicles once they move fully into your lane.
- C There may be issues with the detection of vehicles in front when driving into and coming out of a bend or curve in the road.

Cruise Control (If Equipped)

In these cases, the system may brake late or unexpectedly. You should stay alert and take action when necessary.

If something hits the front end of your vehicle or damage occurs, the radar-sensing zone may change. This could cause missed or false vehicle detection.

Optimal system performance requires a clear view of the road by the windshield-mounted camera.

Optimal performance may not occur if:

- The camera is blocked.
- There is poor visibility or lighting conditions.
- There are bad weather conditions.

Distribute the vehicle load correctly to prevent excessive tilting.

System Not Available

Conditions that can cause the system to deactivate or prevent the system from activating when requested:

- A blocked sensor.
- High brake temperature.
- A failure in the system or a related system.

Blocked Camera and Sensor

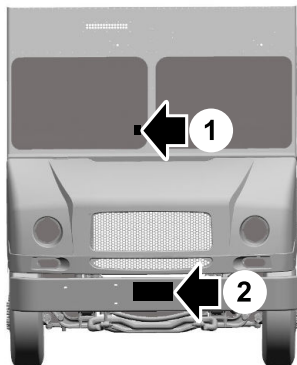

The camera is located low on the windshield in the center.

The sensor is mounted on the bumper

A message displays if something obstructs the radar signals from the sensor. The sensor is in the lower grille. The system cannot detect a vehicle ahead and does not function when something blocks the sensor.

Note: *You cannot see the sensor. It is behind a fascia panel.*

Keep the front of your vehicle free of dirt, metal badges or objects. Vehicle front protectors and aftermarket lights may also block the sensor.

Cruise Control (if Equipped)

Possible causes and actions for a message displaying:

Cause	Details
The surface of the radar is dirty or obstructed	Clean the grille surface in front of the radar or remove the object causing the obstruction.
The surface of the radar is clean but the message remains in the display.	Wait a short time. It may take several minutes for the radar to detect that it is free from obstruction.
Heavy rain or snow is interfering with the radar signals	Do not use the system in these conditions because it may not detect any vehicles ahead.
Water, snow or ice on the surface of the road may interfere with the radar signals.	Do not use the system in these conditions because it may not detect any vehicles ahead.
You are in a desert or remote area with no other vehicles and no roadside objects.	Wait a short time or switch to normal cruise control.

Due to the nature of radar technology, it is possible to get a blockage warning with no actual block. A false blocked condition either self clears, or clears after you restart your vehicle.

Switching to Normal Cruise Control



WARNING: Normal cruise control will not brake when your vehicle is approaching slower vehicles. Always be aware of which mode you have selected and apply the brakes when necessary.

 The cruise control indicator light replaces the adaptive cruise control indicator light if you select normal cruise control. The gap setting does not display, the system does not automatically respond to vehicles in front of you and automatic braking does not activate.

You can change from adaptive cruise control to normal cruise control through the information display.

Driving Aids

DRIVER ALERT (IF EQUIPPED)



WARNING: You are responsible for controlling your vehicle at all times. The system is designed to be an aid and does not relieve you of your responsibility to drive with due care and attention. Failure to follow this instruction could result in the loss of control of your vehicle, personal injury or death.



WARNING: The system may not function if the sensor is blocked.



WARNING: Take regular rest breaks if you feel tired. Do not wait for the system to warn you.



WARNING: Certain driving styles may result in the system warning you even if you are not feeling tired.



WARNING: In cold and severe weather conditions the system may not function. Rain, snow and spray can all limit sensor performance.



WARNING: The system will not operate if the sensor cannot track the road lane markings.



WARNING: If damage occurs in the immediate area surrounding the sensor, have your vehicle checked as soon as possible.



WARNING: The system may not correctly operate if your vehicle is fitted with a suspension kit not approved by us.

Note: Keep the windshield free from obstructions. For example, bird droppings, insects and snow or ice.

Note: If the camera is blocked or if the windshield is damaged, the system may not function.

Note: The system remembers the last setting when you start your vehicle, unless it detects a MyKey™.

Note: If enabled in the menu, the system activates at speeds above 40 mph (64 km/h).

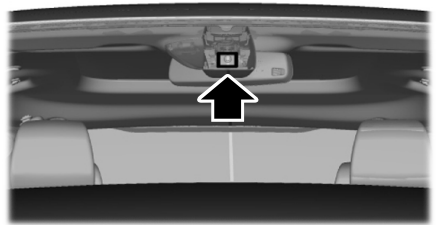

E249505

The system monitors your driving behavior using various inputs including the front camera sensor.

If the system detects reduced driving alertness below a certain threshold, the system alerts you using a tone and a message in the information display.

Using Driver Alert

Switching the system on and off

You may switch the system on or off through the information display by selecting Settings, Driver Assist and then Driver Alert in the menu. When activated, the system monitors your alertness level based upon your driving behavior in relation to the lane markings, and other factors.

System Warnings

Note: The system does not issue warnings below approximately 40 mph (64 km/h).

Driving Aids

The warning system uses two stages. At first the system issues a temporary warning that you need to take a rest. This message only appears for a short time. If the system detects further reduction in driving alertness, another warning could be issued which remains in the information display for a longer time. Press OK on the steering wheel control to clear the warning. When active the system runs in the background and only issues a warning if required.

Resetting the System

You can reset the system by either:

- Switching the ignition off and on.
- Stopping the vehicle and then opening and closing the driver door.

LANE KEEPING SYSTEM (IF EQUIPPED)

WARNING: You are responsible for controlling your vehicle at all times. The system is designed to be an aid and does not relieve you of your responsibility to drive with due care and attention. Failure to follow this instruction could result in the loss of control of your vehicle, personal injury or death.

WARNING: Always drive with due care and attention when using and operating the controls and features on your vehicle.

WARNING: In cold and severe weather conditions the system may not function. Rain, snow and spray can all limit sensor performance.

WARNING: The system will not operate if the sensor cannot track the road lane markings.

WARNING: The sensor may incorrectly track lane markings as other structures or objects. This can result in a false or missed warning.

WARNING: Large contrasts in outside lighting can limit sensor performance.

WARNING: The system may not operate properly if the sensor is blocked. Keep the windshield free from obstruction.

WARNING: If damage occurs in the immediate area surrounding the sensor, have your vehicle checked as soon as possible.

WARNING: The system may not correctly operate if your vehicle is fitted with a suspension kit not approved by us.

Note: The system works if the camera can detect one lane marking at a speed above 40 mph (64 km/h).

Note: The system may not function with a blocked camera, or if the windshield is damaged or dirty.

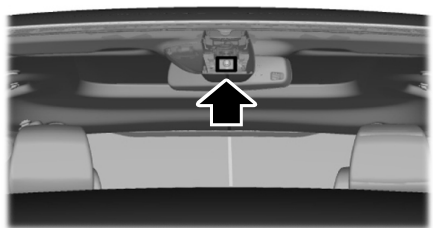

E249505

Driving Aids

When you switch the lane keeping system on and the camera detects a drift out of the travel lane, the system alerts the driver by playing a chime.

Switching the System On and Off

Note: The system stores the on or off setting until you manually change it.



Press the button to switch the system on or off. The button is above the audio unit or on the center console.

System Settings

Adjust the system sensitivity and intensity through the display screen. See **General Information** (page 30). The system remembers the last selection. You do not need to readjust the setting each time you switch on your vehicle.

Sensitivity: This setting allows you to select where you would like to receive the alert within the lane. Increasing the sensitivity setting moves the warning zones in closer to your vehicle.

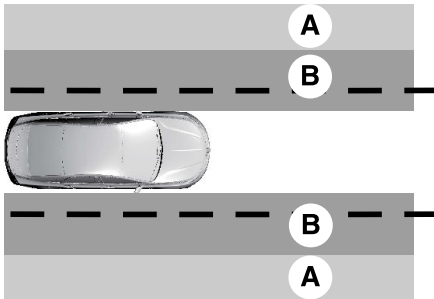

- A Normal
- B Increased

Note: The alert diagram illustrates general zone coverage. It does not provide exact zone parameters.

System Display

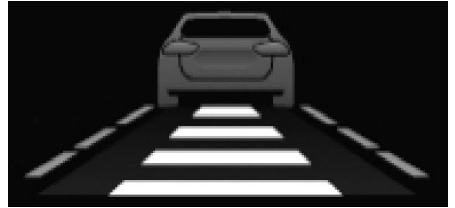

When you switch on the system, a graphic with lane markings appears in the display screen.

Note: The overhead vehicle graphic may still display if adaptive cruise control is enabled.

While the system is on, the color of the lane markings change to indicate the system status.

Gray: Indicates that the system is temporarily unable to provide a warning on the indicated side(s). This may be because:

- Your vehicle is below the activation speed.
- The direction indicator is active.
- Your vehicle is in a dynamic maneuver.
- The road has no or poor lane markings in the camera field-of-view.
- Certain conditions can prevent the camera from detecting the lane markings. These conditions can include any of the following: environmental, traffic, vehicle conditions, significant sun angles, shadows, snow, heavy rain or fog, following a large vehicle that is blocking or shadowing the lane, or poor headlamp illumination.

Driving Aids

See **Troubleshooting** for additional information.

Green: Indicates that the system is available or ready to provide a warning on the indicated side(s).

Red: Indicates that the system is providing or has just provided a lane keeping alert warning.

You can temporarily disable the system at any time by doing the following:

- Quick braking.
- Fast acceleration.
- Using your direction indicator.
- Evasive steering maneuver.
- Driving too close to the lane markings.

Troubleshooting

Why is the feature not available (line markings are gray) when I can see the lane markings on the road?
--

Your vehicle speed is outside the operational range of the feature.

The sun is shining directly into the camera lens.

A quick intentional lane change has occurred.

Your vehicle stays too close to the lane markings.
--

Driving at high speeds in curves.

The last feature activation occurred a short time ago.
--

Ambiguous lane markings, for example in construction zones.

Rapid transition from light to dark, or from dark to light.

Sudden offset in lane markings.

ABS or AdvanceTrac™ is active.

There is a camera blockage due to dirt, grime, fog, frost or water on the windshield.

You are driving too close to the vehicle in front of you.

Transitioning between no lane markings to lane markings or vice versa.
--

There is standing water on the road.

Faint lane markings, for example partial yellow lane markings on concrete roads.
--

Lane width is too narrow or too wide.

No one calibrated the camera after replacing the windshield.
--

Driving on tight roads or on uneven roads.
--

Vehicle accessories are blocking the camera, for example a snowplow.
--

Driving Aids

STEERING

Hydraulic Power Steering

To help prevent damage to the power steering system:

- Do not hold the steering wheel at its furthest turning points for more than three to five seconds when the engine is running.
- Avoid continuously steering back and forth with elevated engine RPM as this may overheat the system. If you are trying to free a stuck vehicle, pause between attempts to allow the power steering system to cool, or seek assistance. Normal steering and driving maneuvers allow the system to cool.
- Do not operate the vehicle if the power steering pump fluid level is below the MIN mark on the reservoir.
- Some noise is normal during operation. If the noise is excessive, check for low power steering pump fluid level before seeking service by your dealer.
- Low power steering fluid could cause the steering to be heavy or uneven. Check for low power steering pump fluid level before seeking service by your dealer.
- Do not fill the power steering pump reservoir above the MAX mark on the reservoir, as this could result in leaks from the reservoir.

If the power steering system breaks down or if you switch the engine off, you can steer the vehicle manually, but it takes more effort.

If you have any steering components serviced or replaced, install new fasteners. Many fasteners have coatings with thread adhesive, or have prevailing torque features you cannot reuse. Do not reuse a bolt or nut. Torque fasteners to specifications.

Steering Tips

If the steering wanders or pulls, check for:

- An improperly inflated tire.
- Uneven tire wear.
- Loose or worn suspension components.
- Loose or worn steering components.
- Improper vehicle alignment.

Note: *A high crown in the road or high crosswinds may also make the steering seem to wander or pull.*

PRE-COLLISION ASSIST (IF EQUIPPED)



WARNING: You are responsible for controlling your vehicle at all times. The system is designed to be an aid and does not relieve you of your responsibility to drive with due care and attention. Failure to follow this instruction could result in the loss of control of your vehicle, personal injury or death.





WARNING: The system does not operate during hard acceleration or steering. Failure to take care may lead to a crash or personal injury.



WARNING: The system may operate with reduced function during cold and inclement weather conditions. Snow, ice, rain, spray and fog can adversely affect the system. Keep the front camera and radar free of snow and ice. Failure to follow this instruction may result in the loss of control of your vehicle, serious personal injury or death.

Driving Aids

 **WARNING:** System performance could be reduced in situations where the vehicle camera has limited detection capability. These situations include but are not limited to direct or low sunlight, vehicles at night without tail lights, unconventional vehicle types, and pedestrians and cyclists with complex, partially obscured backgrounds. Failure to take care may result in the loss of control of your vehicle, personal injury or death.

 **WARNING:** The system cannot help prevent all crashes. Do not rely on this system to replace driver judgment and the need to maintain a safe distance and speed.

 **WARNING:** Take additional care if your vehicle is heavily loaded or you are towing a trailer. These conditions could result in reduced performance of this system. Failure to follow this instruction could result in the loss of control of your vehicle, personal injury or death.

Using the Pre-Collision Assist System

The pre-collision assist system is active at speeds above 3 mph (5 km/h). Pedestrian detection functions at speeds up to 50 mph (80 km/h).



If your vehicle is rapidly approaching another stationary vehicle or a vehicle traveling in the same direction the system provides three levels of functionality:

- Alert.
- Brake support.
- Active braking.

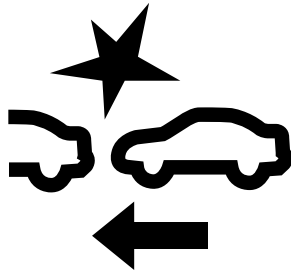

Alert: When active, a flashing visual warning appears and an audible warning tone sounds.

Brake support: Helps reduce the impact speed by preparing the brakes for rapid braking. The system does not automatically apply the brakes. If you press the brake pedal, the system could apply additional braking up to maximum braking force, even if you lightly press the brake pedal.

Active braking: May activate if the system determines that a collision is imminent. The system may help the driver reduce impact damage or avoid the crash completely.

Note: *If you perceive pre-collision assist alerts as being too frequent, you can reduce the alert sensitivity, though the manufacturer recommends using the highest sensitivity setting where possible. Setting lower sensitivity would lead to fewer and later system warnings.*

Distance Indication and Alert

Provides the driver with a graphical indication of the time gap to other preceding vehicles traveling in the same direction. The distance indication and alert screen in the instrument cluster display shows one of the following graphics.

Driving Aids

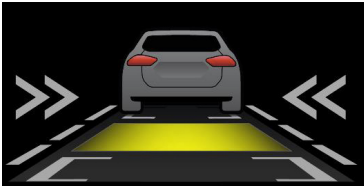
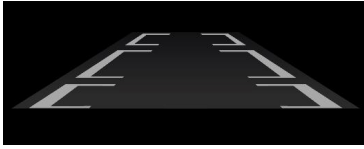

If the time gap to a preceding vehicle is small, a red visual indication displays.

Note: Distance indication and alert deactivates and the graphics do not display when adaptive cruise control is active.

Adjusting the Pre-Collision Assist Settings

You can adjust the following settings by using the instrument cluster display controls. See **General Information** (page 30).

- You can change alert and distance alert sensitivity to one of three possible settings.
- You can switch distance indication and alert on or off.

- If required, you can switch active braking on or off.
- If required, you can switch the pre-collision assist feature on or off.

Note: The system turns on active braking every time you switch the ignition on.

Note: Switch the system off if you install a snowplow or similar object in such a way that it may block the radar sensor. Your vehicle remembers the selected setting across key cycles.

Blocked Sensors

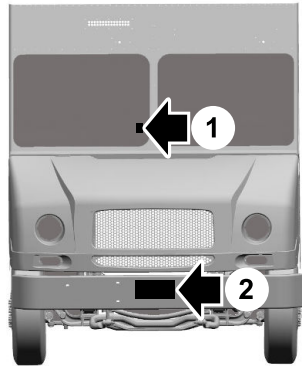

- 1 Camera.
- 2 Radar sensor.

When the radar signals or camera images are obstructed, the system provides a message in the instrument cluster display regarding a blocked sensor or camera. With a blocked sensor or camera, the pre-collision assist system may not function, or performance may reduce. The following table lists possible causes and actions for when this message displays.

Driving Aids

Camera Troubleshooting

Cause	Action
The windshield in front of the camera is dirty or obstructed in some way.	Clean the outside of the windshield in front of the camera.
The windshield in front of the camera is clean but the message remains in the display screen.	Wait a short time. It may take several minutes for the camera to detect that there is no obstruction.
The vehicle is tilted excessively due to overloading or incorrect load distribution.	Reduce or redistribute the load to prevent vehicle tilting.

Radar Troubleshooting

Cause	Action
The surface of the radar in the grille is dirty or obstructed in some way.	Clean the grille surface in front of the radar or remove the object causing the obstruction.
The surface of the radar in the grille is clean but the message remains in the display screen.	Wait a short time. It may take several minutes for the radar to detect that there is no obstruction.
Heavy rain, road spray, snow or fog is interfering with the radar signals.	The pre-collision assist system is temporarily disabled. Pre-collision assist automatically reactivates a short time after the weather conditions improve.
Swirling water or snow or ice on the surface of the road may interfere with the radar signals.	The pre-collision assist system is temporarily disabled. Pre-collision assist automatically reactivates a short time after the weather conditions improve.
Radar is out of alignment due to a front end impact.	Contact an authorized dealer to have the radar checked for proper coverage and operation.

Note: Proper system operation requires the camera have an unobstructed view of the road. Repair any windshield damage in the area of the camera's field of view.

Note: If something hits the front end of your vehicle or damage occurs and your vehicle has a radar sensor, the radar sensing zone may change. This could cause missed or false vehicle detections. Contact an authorized dealer to have the radar checked for proper coverage and operation.

Driving Aids

Note: *If your vehicle detects excessive heat at the camera or a potential misalignment condition, a message may display in the instrument cluster display indicating the sensor is temporarily unavailable. When operational conditions are correct, the message deactivates. For example, when the ambient temperature around the sensor decreases or the sensor successfully recalibrates.*

Load Carrying

LOAD LIMIT

Vehicle Loading - with and without a Trailer

This section guides you in the proper loading of your vehicle, trailer, or both. Keep your loaded vehicle weight within its design rating capability, with or without a trailer. Properly loading your vehicle provides maximum return of vehicle design performance. Before you load your vehicle, become familiar with the following terms for determining your vehicle's weight rating, with or without a trailer, from the vehicle's Tire and Loading Information label or Safety Compliance Certification label.

Tire and Loading Label Information Example:



TIRE AND LOADING INFORMATION

SEATING CAPACITY / TOTAL: 5 FRONT: 2 REAR: 3

The combined weight of occupants and cargo should never exceed 385 kg or 850 lbs.

TIRE	SIZE	COLD TIRE PRESSURE
FRONT	XXX/XXXXX XXX	XXXKPA, XXPSI
REAR	XXX/XXXXX XXX	XXXKPA, XXPSI
SPARE	NONE	NONE

SEE OWNER'S
MANUAL FOR
ADDITIONAL
INFORMATION



TIRE AND LOADING INFORMATION RENSEIGNEMENTS SUR LES PNEUS ET LE CHARGEMENT

SEATING CAPACITY / NOMBRE DE PLACES TOTAL: 5 FRONT: 2 REAR: 3

The combined weight of occupants and cargo should never exceed 396 kg or 875 lbs.
Le poids total des occupants et du chargement ne doit jamais dépasser 396 kg ou 875 lbs.

TIRE / PNEU	SIZE / DIMENSIONS	COLD TIRE PRESSURE / PRESSION DES PNEUS A FROID
FRONT / AVANT	XXX/XXXXX XXX	XXXKPA, XXPSI
REAR / ARRIERE	XXX/XXXXX XXX	XXXKPA, XXPSI
SPARE / SECOURS	XXX/XXXXX XXX	XXXKPA, XXPSI

SEE OWNER'S
MANUAL FOR
ADDITIONAL
INFORMATION
VOIR LE MANUEL
DE L'USAGER
POUR PLUS DE
RENSEIGNEMENTS

Payload

Payload is the combined weight of cargo and passengers that your vehicle is carrying. The maximum payload for your vehicle appears on the Tire and Loading label. The label is either on the B-pillar or the edge of the driver door. Vehicles exported outside the US and Canada may not have a tire and loading label. Look for "The combined weight of occupants and cargo should never exceed XXX kg OR XXX lb" for maximum payload. The payload listed on the Tire and Loading Information label

Load Carrying



WARNING: Exceeding the Safety Compliance Certification label vehicle weight limits can adversely affect the performance and handling of your vehicle, cause vehicle damage and can result in the loss of control of your vehicle, serious personal injury or death.

Maximum Loaded Trailer Weight

Maximum loaded trailer weight is the highest possible weight of a fully loaded trailer the vehicle can tow. Consult an authorized dealer (or the RV and Trailer Towing Guide available at an authorized dealer) for more detailed information.

GCWR (Gross Combined Weight Rating)

GCWR is the maximum allowable weight of the vehicle and the loaded trailer, including all cargo and passengers, that the vehicle can handle without risking damage. (Important: The towing vehicle's braking system is rated for operation at Gross Vehicle Weight Rating, not at Gross Combined Weight Rating.) Separate functional brakes should

be used for safe control of towed vehicles and for trailers where the Gross Combined Weight of the towing vehicle plus the trailer exceed the Gross Vehicle Weight Rating of the towing vehicle.

The gross combined weight must never exceed the Gross Combined Weight Rating.

Note: For trailer towing information refer to the *RV and Trailer Towing Guide* available at an authorized dealer, or online at the website that follows.

Market	Website
United states of America	https://www.fleet.ford.com/towing-guides/
Canada	https://www.fleet.ford.ca/towing-guides/



WARNING: Do not exceed the GVWR or the GAWR specified on the certification label.



WARNING: Do not use replacement tires with lower load carrying capacities than the original tires because they may lower your vehicle's GVWR and GAWR limitations. Replacement tires with a higher limit than the original tires do not increase the GVWR and GAWR limitations.

Load Carrying



WARNING: Exceeding any vehicle weight rating can adversely affect the performance and handling of your vehicle, cause vehicle damage and can result in the loss of control of your vehicle, serious personal injury or death.

Steps for determining the correct load limit:

1. Locate the statement "The combined weight of occupants and cargo should never exceed XXX kg or XXX lb." on your vehicle's placard.
2. Determine the combined weight of the driver and passengers that will be riding in your vehicle.
3. Subtract the combined weight of the driver and passengers from XXX kg or XXX lb.
4. The resulting figure equals the available amount of cargo and luggage load capacity. For example, if the "XXX" amount equals 1,400 lb. and there will be five 150 lb. passengers in your vehicle, the amount of available cargo and luggage load capacity is 650 lb. $(1400 - 750 (5 \times 150) = 650 \text{ lb.})$
5. Determine the combined weight of luggage and cargo being loaded on the vehicle. That weight may not safely exceed the available cargo and luggage load capacity calculated in Step 4.
6. If your vehicle will be towing a trailer, load from your trailer will be transferred to your vehicle. Consult this manual to determine how this reduces the available cargo and luggage load capacity of your vehicle.

Helpful examples for calculating the available amount of cargo and luggage load capacity

Suppose your vehicle has a 1400-pound (635-kilogram) cargo and luggage capacity. You decide to go golfing. Is there enough load capacity to carry you, four of your friends and all the golf bags? You and four friends average 220 pounds (99 kilograms) each and the golf bags weigh approximately 30 pounds (13.5 kilograms) each. The calculation would be: $1400 - (5 \times 220) - (5 \times 30) = 1400 - 1100 - 150 = 150$ pounds. Yes, you have enough load capacity in your vehicle to transport four friends and your golf bags. In metric units, the calculation would be: $635 \text{ kilograms} - (5 \times 99 \text{ kilograms}) - (5 \times 13.5 \text{ kilograms}) = 635 - 495 - 67.5 = 72.5$ kilograms.

Load Carrying

Suppose your vehicle has a 1400-pound (635-kilogram) cargo and luggage capacity. You and one of your friends decide to pick up cement from the local home improvement store to finish that patio you have been planning for the past two years. Measuring the inside of the vehicle with the rear seat folded down, you have room for twelve 100-pound (45-kilogram) bags of cement. Do you have enough load capacity to transport the cement to your home? If you and your friend each weigh 220 pounds (99 kilograms), the calculation would be: $1400 - (2 \times 220) - (12 \times 100) = 1400 - 440 - 1200 = -240$ pounds. No, you do not have enough cargo capacity to carry that much weight. In metric units, the calculation would be: $635 \text{ kilograms} - (2 \times 99 \text{ kilograms}) - (12 \times 45 \text{ kilograms}) = 635 - 198 - 540 = -103$ kilograms. You will need to reduce the load weight by at least 240 pounds (104 kilograms). If you remove three 100-pound (45-kilogram) cement bags, then the load calculation would be: $1400 - (2 \times 220) - (9 \times 100) = 1400 - 440 - 900 = 60$ pounds. Now you have the load capacity to transport the cement and your friend home. In metric units, the calculation would be: $635 \text{ kilograms} - (2 \times 99 \text{ kilograms}) - (9 \times 45 \text{ kilograms}) = 635 - 198 - 405 = 32$ kilograms.

The above calculations also assume that the loads are positioned in your vehicle in a manner that does not overload the front or the rear gross axle weight rating specified for your vehicle on the Safety Compliance Certification label.

Special Loading Instructions for Owners of Pick-up Trucks and Utility-type Vehicles



WARNING: When loading the roof racks, we recommend you evenly distribute the load, as well as maintain a low center of gravity. Loaded vehicles, with higher centers of gravity, may handle differently than unloaded vehicles. Take extra precautions, such as slower speeds and increased stopping distance, when driving a heavily loaded vehicle.

Towing

TOWING A TRAILER



WARNING: Towing trailers beyond the maximum recommended gross trailer weight exceeds the limit of your vehicle and could result in engine damage, transmission damage, structural damage, loss of vehicle control, vehicle rollover and personal injury.



WARNING: Do not exceed the GVWR or the GAWR specified on the certification label.

Note: See *Recommended Towing Weights* (page 84).

Your vehicle may have electrical items, such as fuses or relays, related to towing. See **Fuses** (page 101).

Your vehicle's load capacity designation is by weight, not by volume, so you cannot necessarily use all available space when loading a vehicle or trailer.

Towing a trailer places an extra load on your vehicle's engine, transmission, axle, brakes, tires and suspension. Inspect these components periodically during, and after, any towing operation.

Load Placement

To help minimize how trailer movement affects your vehicle when driving:

- Load the heaviest items closest to the trailer floor.
- Load the heaviest items centered between the left and right side trailer tires.
- Load the heaviest items above the trailer axles or just slightly forward toward the trailer tongue. Do not allow the final trailer tongue weight to go above or below 10-15% of the loaded trailer weight.
- Select a ball mount with the correct rise or drop and load capacity. When both the loaded vehicle and trailer are connected, the trailer frame should be level, or slightly angled down toward your vehicle, when viewed from the side.

When driving with a trailer or payload, a slight takeoff vibration or shudder may be present due to the increased payload weight. Additional information regarding proper trailer loading and setting your vehicle up for towing is located in another chapter of this manual. See **Load Limit** (page 78).

You can also find information in the **RV & Trailer Towing Guide** available at your authorized dealer, or online.

Towing

RV & Trailer Towing Guide Online	
Website	http://www.fleet.ford.com/towing-guides/

RECOMMENDED TOWING WEIGHTS

Market	Website
United States of America	https://www.fordpro.com/en-us/fleet-vehicles/manuals-and-guides/
Canada	https://www.fordpro.com/en-us/fleet-vehicles/manuals-and-guides/

Towing

ESSENTIAL TOWING CHECKS

Follow these guidelines for safe towing:

- Do not tow a trailer until you drive your vehicle at least 1,000 mi (1,600 km).
- Consult your local motor vehicle laws for towing a trailer.
- See the instructions included with towing accessories for the proper installation and adjustment specifications.
- Service your vehicle more frequently if you tow a trailer. See **Scheduled Maintenance** (page 165).
- If you use a rental trailer, follow the instructions the rental agency gives you.

Another chapter of this manual contains load specification terms found on the tire label and Safety Compliance label and instructions on calculating your vehicle's load. See **Load Limit** (page 78).

Remember to account for the trailer tongue weight as part of your vehicle load when calculating the total vehicle weight.

Hitches

Do not use a hitch that either clamps onto the bumper or attaches to the axle.

Distribute the trailer load so 10-15% of the total trailer weight is on the tongue.

Weight-Distributing Hitches



WARNING: Do not adjust the spring bars so that your vehicle's rear bumper is higher than before attaching the trailer. Doing so will defeat the function of the weight-distributing hitch, which may cause unpredictable handling, and could result in serious personal injury.

When hooking-up a trailer using a weight-distributing hitch, always use the following procedure:

1. Park the loaded vehicle, without the trailer, on a level surface.
2. Measure the height to the top of your vehicle's front wheel opening on the fender. This is H1.
3. Securely attach the loaded trailer to your vehicle without the weight-distributing bars connected.
4. Measure the height to the top of your vehicle's front wheel opening on the fender a second time. This is H2.
5. Install and adjust the tension in the weight-distributing bars so that the height of your vehicle's front wheel opening on the fender is approximately halfway between H1 and H2.
6. Check that the trailer is level or slightly nose down toward your vehicle. If not, adjust the ball height accordingly and repeat Steps 1-6.
7. Lock the bar tension adjuster in place.
8. Check that the trailer tongue securely attaches and locks onto the hitch.
9. Install safety chains, lighting and trailer brake controls as required by law or the trailer manufacturer.

Safety Chains

Note: *Never attach safety chains to the bumper.*

Always connect the safety chains to the hook retainers of your vehicle hitch.

To connect the safety chains, cross them under the trailer tongue and allow enough slack for turning tight corners. Do not allow the chains to drag on the ground.

Towing

Trailer Brakes



WARNING: Do not connect a trailer's hydraulic brake system directly to your vehicle's brake system. Your vehicle may not have enough braking power and your chances of having a collision greatly increase.

Electric brakes and manual, automatic or surge-type trailer brakes are safe if you install them properly and adjust them to the manufacturer's specifications. The trailer brakes must meet local and federal regulations.

The rating for the tow vehicle's braking system operation is at the gross vehicle weight rating, not the gross combined weight rating.

Separate functioning brake systems are required for safe control of towed vehicles and trailers weighing more than 1500 lb (680 kg) when loaded.

Trailer Lamps



WARNING: Never connect any trailer lamp wiring to the vehicle's tail lamp wiring; this may damage the electrical system resulting in fire. Contact your authorized dealer as soon as possible for assistance in proper trailer tow wiring installation. Additional electrical equipment may be required.

Trailer lamps are required on most towed vehicles. Make sure all running lights, brake lights, direction indicators and hazard lights are working.

Before Towing a Trailer

Practice turning, stopping and backing up to get the feel of your vehicle-trailer combination before starting on a trip. When turning, make wider turns so the trailer wheels clear curbs and other obstacles.

When Towing a Trailer

- Do not drive faster than 70 mph (113 km/h) during the first 500 mi (800 km).
- Do not make full-throttle starts.
- Check your hitch, electrical connections and trailer wheel lug nuts thoroughly after you have traveled 50 mi (80 km).
- When stopped in congested or heavy traffic during hot weather, place the gearshift in park (P) to aid engine and transmission cooling and to help air conditioning performance.
- Switch off the speed control with heavy loads or in hilly terrain. The speed control may turn off automatically when you are towing on long, steep grades.
- Shift to a lower gear when driving down a long or steep hill. Do not apply the brakes continuously, as they may overheat and become less effective.
- If your transmission is equipped with a Grade Assist or Tow/Haul feature, use this feature when towing. This provides engine braking and helps eliminate excessive transmission shifting for optimum fuel economy and transmission cooling.
- Allow more distance for stopping with a trailer attached. Anticipate stops and brake gradually.
- Avoid parking on a grade. However, if you must park on a grade:
 1. Turn the steering wheel to point your vehicle tires away from traffic flow.

Towing

2. Set your vehicle parking brake.
3. Place the automatic transmission in park (P).
4. Place wheel chocks in the front and back of the trailer wheels. (Chocks not included with vehicle.)

Launching or Retrieving a Boat or Personal Watercraft (PWC)

Note: *Disconnect the wiring to the trailer before backing the trailer into the water.*

Note: *Reconnect the wiring to the trailer after removing the trailer from the water.*

When backing down a ramp during boat launching or retrieval:

- Do not allow the static water level to rise above the bottom edge of the rear bumper.
- Do not allow waves to break higher than 6 in (15 cm) above the bottom edge of the rear bumper.

Exceeding these limits may allow water to enter vehicle components:

- Causing internal damage to the components.
- Affecting driveability, emissions and reliability.

Replace the rear axle lubricant anytime the rear axle has been submerged in water. Water may have contaminated the rear axle lubricant, which is not normally checked or changed unless a leak is suspected or other axle repair is required.

TOWING THE VEHICLE ON FOUR WHEELS

Emergency Towing



WARNING: If your vehicle has a steering wheel lock make sure the ignition is in the accessory or on position when being towed.

If your vehicle becomes inoperable (without access to wheel dollies, car-hauling trailer, or flatbed transport vehicle), it can be flat-towed (all wheels on the ground, regardless of the powertrain and transmission configuration) under the following conditions:

- Your vehicle is facing forward for towing in a forward direction.
- Place the transmission in neutral (N). If you cannot move the transmission into neutral (N), you may need to override it.
- Maximum speed is 35 mph (56 km/h).
- Maximum distance is 50 mi (80 km).

Driving Hints

REDUCED ENGINE PERFORMANCE



WARNING: If you continue to drive your vehicle when the engine is overheating, the engine could stop without warning. Failure to follow this instruction could result in the loss of control of your vehicle.

If the engine coolant temperature gauge needle moves to the upper limit position, the engine is overheating. See **Gauges** (page 24).

You must only drive your vehicle for a short distance if the engine overheats. The distance you can travel depends on ambient temperature, vehicle load and terrain. The engine continues to operate with limited power for a short period of time.

If the engine temperature continues to rise, the fuel supply to the engine reduces. The air conditioning switches off and the engine cooling fan operates continually.

1. Gradually reduce your speed and stop your vehicle as soon as it is safe to do so.
2. Immediately switch the engine off to prevent severe engine damage.
3. Wait for the engine to cool down.
4. Check the coolant level. See **Engine Coolant Check** (page 115).
5. Have your vehicle checked as soon as possible.

ECONOMICAL DRIVING

Fuel economy is affected by several things such as how you drive, the conditions you drive under and how you maintain your vehicle.

There are some things to keep in mind that may improve fuel economy:

- Accelerate and slow down in a smooth, moderate fashion.
- Drive at reasonable and steady speeds.
- Anticipate stops.
- Minimize stop and go driving.
- Close the windows when driving at higher speed.
- Keep the tires properly inflated and use only the recommended size.
- Use the recommended engine oil.
- Perform all regularly scheduled maintenance.

Avoid these actions; they reduce fuel economy:

- Sudden or hard accelerations.
- Revving the engine before turning it off.
- Idle for periods longer than one minute.
- Warm up your vehicle on cold mornings.
- Using air conditioning.
- Using speed control in hilly terrain.
- Resting your foot on the brake pedal while driving.
- Driving with the wheels out of alignment.

Conditions:

- Adding certain accessories to your vehicle may reduce fuel economy. For example, bug deflectors, rollbars, light bars, running boards, ski racks or luggage racks.
- Using fuel blended with alcohol may lower fuel economy.
- Fuel economy may decrease with lower temperatures during the first 5–10 mi (12–16 km) of driving.

Driving Hints

- Driving on flat terrain offers improved fuel economy as compared to driving on hilly terrain.
- Transmissions give their best fuel economy when operated in the top cruise gear and with steady pressure on the gas pedal.

BREAKING-IN

You need to break in new tires for approximately 300 mi (480 km). During this time, your vehicle may exhibit some unusual driving characteristics.

Avoid driving too fast during the first 1,000 mi (1,600 km). Vary your speed frequently and change up through the gears early. Do not labor the engine.

Do not tow during the first 1,000 mi (1,600 km).

DRIVING THROUGH WATER



WARNING: Do not drive through flowing or deep water as you may lose control of your vehicle.

Note: *Driving through standing water can cause vehicle damage.*

Note: *Engine damage can occur if water enters the air filter.*

Before driving through standing water, check the depth. Never drive through water that is higher than the bottom of the wheel hubs.

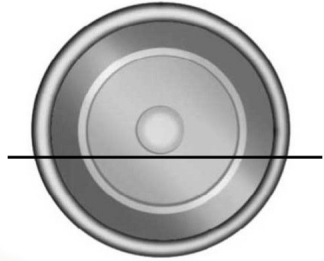

When driving through standing water, drive very slowly and do not stop your vehicle. Your brake performance and traction may be limited. After driving through water and as soon as it is safe to do so:

- Lightly press the brake pedal to dry the brakes and to check that they work.
- Check that the horn works.
- Check that the exterior lights work.
- Turn the steering wheel to check that the steering power assist works.

Roadside Emergencies

HAZARD FLASHERS

Note: *If used when the vehicle is not running, the battery loses charge. As a result, there may be insufficient power to restart your vehicle.*

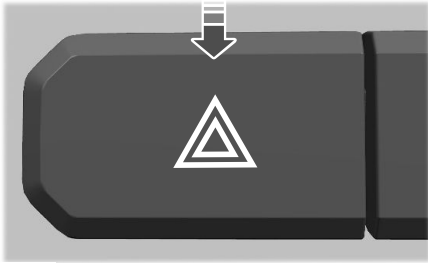

The hazard flasher control is located on the instrument panel. Use it when your vehicle is creating a safety hazard for other motorists.

- Press the flasher control and all front and rear direction indicators flash.
- Press the flasher control again to switch them off.

JUMPSTARTING THE VEHICLE

WARNING: Batteries normally produce explosive gases which can cause personal injury. Therefore, do not allow flames, sparks or lighted substances to come near the battery. When working near the battery, always shield your face and protect your eyes. Always provide correct ventilation.

WARNING: Keep batteries out of reach of children. Batteries contain sulfuric acid. Avoid contact with skin, eyes or clothing. Shield your eyes when working near the battery to protect against possible splashing of acid solution. In case of acid contact with skin or eyes, flush immediately with water for a minimum of 15 minutes and get prompt medical attention. If acid is swallowed, call a physician immediately.

WARNING: Use only adequately sized cables with insulated clamps.

Preparing Your Vehicle

Do not attempt to push-start your automatic transmission vehicle.

Note: *Attempting to push-start a vehicle with an automatic transmission may cause transmission damage.*

Note: *Use only a 12-volt supply to start your vehicle.*

Note: *Do not disconnect the battery of the disabled vehicle as this could damage the vehicle electrical system.*

Park the booster vehicle close to the hood of the disabled vehicle, making sure the two vehicles do not touch.

Connecting the Jumper Cables

WARNING: Do not attach the cables to fuel lines, engine rocker covers, the intake manifold or electrical components as grounding points. Stay clear of moving parts. To avoid reverse polarity connections, make sure that you correctly identify the positive (+) and negative (-) terminals on both the disabled and booster vehicles before connecting the cables.

Roadside Emergencies



WARNING: Do not attach the end of the positive cable to the studs or L-shaped eyelet located above the positive (+) terminal of your vehicle's battery. High current may flow through and cause damage to the fuses.



WARNING: Do not connect the end of the second cable to the negative (-) terminal of the battery to be jumped. A spark may cause an explosion of the gases that surround the battery.

Note: In the illustration, the bottom vehicle represents the booster vehicle.

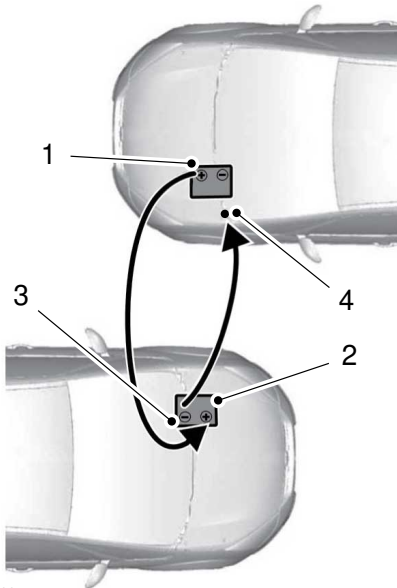

E142664

1. Connect the positive (+) jumper cable to the positive (+) terminal of the discharged battery.

2. Connect the other end of the positive (+) cable to the positive (+) terminal of the booster vehicle battery.
3. Connect the negative (-) cable to the negative (-) terminal of the booster vehicle battery.
4. Make the final connection of the negative (-) cable to an exposed metal part of the stalled vehicle's engine, away from the battery and the fuel injection system, or connect the negative (-) cable to a ground connection point if available.

Jump Starting

1. Start the engine of the booster vehicle and rev the engine moderately, or press the accelerator gently to keep your engine speed between 2000 and 3000 RPM, as shown in your tachometer.
2. Start the engine of the disabled vehicle.
3. Once the disabled vehicle has been started, run both vehicle engines for an additional three minutes before disconnecting the jumper cables.

Removing the Jumper Cables

Remove the jumper cables in the reverse order that they were connected.

Roadside Emergencies

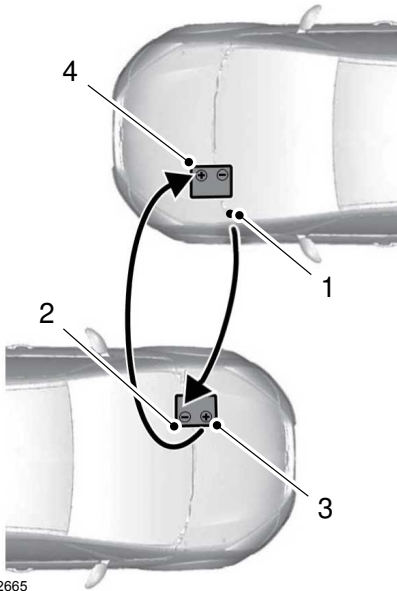

E142665



WARNING: Unexpected and possibly sudden vehicle movement may occur if you do not take these precautions.

If you need to have your vehicle towed, contact a professional towing service or, if you are a member of a roadside assistance program, your roadside assistance service provider.

We recommend the use of a wheel lift and dollies or flatbed equipment to tow your vehicle. Do not tow with a slingbelt. Ford Motor Company has not approved a slingbelt towing procedure. Vehicle damage may occur if towed incorrectly, or by any other means.

Ford Motor Company produces a towing manual for all authorized tow truck operators. Have your tow truck operator refer to this manual for proper hook-up and towing procedures for your vehicle.

It is acceptable to have your two-wheel drive vehicle towed with the front wheels on the ground without dollies and the rear wheels off the ground.

1. Remove the negative (-) jumper cable from the disabled vehicle.
2. Remove the jumper cable on the negative (-) terminal of the booster vehicle battery.
3. Remove the jumper cable from the positive (+) terminal of the booster vehicle battery.
4. Remove the jumper cable from the positive (+) terminal of the disabled vehicle battery.
5. Allow the engine to idle for at least one minute.

TRANSPORTING THE VEHICLE



WARNING: Block the wheels to help prevent the vehicle from moving.

Crash and Breakdown Information

ROADSIDE ASSISTANCE

Vehicles Sold in the United States: Getting Roadside Assistance

If you have a vehicle concern, Ford Motor Company offers a complimentary roadside assistance program. This program is separate from the New Vehicle Limited Warranty.

The service is available:

- 24 hours a day, seven days a week.
- For the coverage period supplied with your vehicle.

Knowing your vehicle's VIN, mileage and your specific location allows help to get to you faster.

Roadside Assistance covers:

- A flat tire change with a good spare (except vehicles supplied with a tire inflation kit).
- Battery jump start.
- Lock-out assistance (key replacement cost is the customer's responsibility).
- Fuel delivery — independent service contractors, if not prohibited by state, local or municipal law, shall deliver up to 2 gal (8 L) of gasoline or 5 gal (20 L) of diesel fuel to a disabled vehicle. Roadside assistance limits fuel delivery service to two no-charge occurrences within a 12-month period.
- Winch out — available within 100 ft (30 m) of a paved or county maintained road, no recoveries.

- Towing — independent service contractors, if not prohibited by state, local or municipal law, shall tow Ford eligible vehicles to an authorized dealer within 50 mi (80 km) of the disablement location or to the nearest authorized dealer. If a member requests a tow to an authorized dealer that is more than 50 mi (80 km) from the disablement location, the member shall be responsible for any mileage costs in excess of 50 mi (80 km). Warranty towing, non-warranty towing and collision towing are available.
- Roadside Assistance includes up to \$200 for a towed trailer if the disabled eligible vehicle requires service at the nearest authorized dealer. If the towing vehicle is operational but the trailer is not, then the trailer does not qualify for any roadside services.

Vehicles Sold in the United States: Using Roadside Assistance

United States vehicle customers who require Roadside Assistance, call 1-800-241-3673.

If you need to arrange roadside assistance on your own, Ford Motor Company reimburses a reasonable amount for towing to the nearest dealership within 50 mi (80 km). To obtain reimbursement information, United States vehicle customers call 1-800-241-3673. Customers need to submit their original receipts.

Vehicles Sold in Canada: Getting Roadside Assistance

If you have a vehicle concern, Ford Motor Company of Canada, Limited offers a complimentary roadside assistance program. This program is eligible within Canada or the continental United States.

The service is available 24 hours a day, seven days a week.

Crash and Breakdown Information

This program is separate from the New Vehicle Limited Warranty, but the coverage is concurrent with the powertrain coverage period of your vehicle. Canadian roadside coverage and benefits may differ from the U.S. coverage. For complete details, see your Warranty Guide at www.ford.com/support/warranty/.

Download the Sykes4Ford Roadside Assistance App for access to your roadside assistance services. For more information, scan here:



If you require more information, please call us in Canada at 1-800-665-2006, or visit our website at www.ford.ca.

Ford Motor Company reserves the right to modify or discontinue Roadside Assistance at any time. Certain restrictions apply to Roadside Assistance benefits.

For further details, call
1-800-665-2006 (Canada)
1-800-241-3673 (United States)

Customer Assistance

GETTING THE SERVICES YOU NEED

Warranty repairs to your vehicle must be performed by an authorized dealer. While any authorized dealer handling your vehicle line will provide warranty service, we recommend you return to your selling authorized dealer who wants to ensure your continued satisfaction.

Please note that certain warranty repairs require special training and equipment, so not all authorized dealers are authorized to perform all warranty repairs. This means that, depending on the warranty repair needed, you may have to take your vehicle to another authorized dealer.

A reasonable time must be allowed to perform a repair after taking your vehicle to the authorized dealer. Repairs will be made using Ford or Motorcraft® parts, or remanufactured or other parts that are authorized by Ford.

Away From Home

If you are away from home when your vehicle needs service, contact the Ford Customer Relationship Center or use the online resources listed below to find the nearest authorized dealer.

In the United States:

Mailing address

Ford Motor Company
Customer Relationship Center
P.O. Box 6248
Dearborn, MI 48126

Telephone

1-800-392-3673 (FORD)
(TDD for the hearing impaired:
1-800-232-5952)
If your vehicle is configured as a motorhome please call 1-800-444-3311 for support.

Additional information and resources are available online:

Website
www.owner.ford.com

These are some of the items that can be found online:

- U.S. dealer locator by Dealer Name, City/State or Zip Code.
- Owner Manuals.
- Maintenance Schedules.
- Recalls.
- Ford Extended Service Plans.
- Ford Genuine Accessories.
- Service specials and promotions.

In Canada:

Mailing address

Customer Relationship Centre
Ford Motor Company of Canada, Limited
P.O. Box 2000
Oakville, Ontario L6K 0C8

Telephone

1-800-565-3673 (FORD)
7-1-1 (Customer Service for Deaf and Hard-of-Hearing Customers)

Website
www.ford.ca

Additional Assistance

If you have questions or concerns, or are unsatisfied with the service you are receiving, follow these steps:

1. Contact your Sales Representative or Service Advisor at your selling or servicing authorized dealer.

Customer Assistance

2. If your inquiry or concern remains unresolved, contact the Sales Manager, Service Manager or Customer Relations Manager.
3. If you require assistance or clarification on Ford Motor Company policies, please contact the Ford Customer Relationship Center.

In order to help us serve you better, please have the following information available when contacting a Customer Relationship Center:

- Vehicle Identification Number.
- Your telephone number (home and business).
- The name of the authorized dealer and city where located.
- The vehicle's current odometer reading.

In some states within the United States, you must directly notify Ford in writing before pursuing remedies under your state's warranty laws, and Ford is also allowed a final repair attempt.

Additionally, in some states within the United States, a consumer has the option of submitting a warranty dispute to the BBB Auto Line before taking action under the Magnuson-Moss Warranty Act, or to the extent allowed by state law, before pursuing replacement or repurchase remedies provided by certain state laws. This dispute handling procedure is not required prior to enforcing state created rights or other rights which are independent of the Magnuson-Moss Warranty Act or state replacement or repurchase laws.

IN CALIFORNIA (U.S. ONLY)

California Civil Code Section 1793.2(d) requires that, if a manufacturer or its representative is unable to repair a motor vehicle to conform to the vehicle's applicable express warranty after a reasonable number of attempts, the manufacturer shall be required to either replace the vehicle with one substantially identical or repurchase the vehicle and reimburse the buyer in an amount equal to the actual price paid or payable by the consumer (less a reasonable allowance for consumer use). The consumer has the right to choose whether to receive a refund or replacement vehicle.

California Civil Code Section 1793.22(b) presumes that the manufacturer has had a reasonable number of attempts to conform the vehicle to its applicable express warranties if, within the first 18 months of ownership of a new vehicle or the first 18,000 mi (29,000 km), whichever occurs first:

1. Two or more repair attempts are made on the same non-conformity likely to cause death or serious bodily injury OR
2. Four or more repair attempts are made on the same nonconformity (a defect or condition that substantially impairs the use, value or safety of the vehicle) OR
3. The vehicle is out of service for repair of nonconformities for a total of more than 30 calendar days (not necessarily all at one time).

In the case of 1 or 2 above, the consumer must also notify the manufacturer of the need for the repair of the nonconformity at the following address:

Ford Motor Company
16800 Executive Plaza Drive
Mail Drop 3NE-B
Dearborn, MI 48126

Customer Assistance

You are required to submit your warranty dispute to BBB AUTO LINE before asserting in court any rights or remedies conferred by California Civil Code Section 1793.22(b). You are also required to use BBB AUTO LINE before exercising rights or seeking remedies created by the Federal Magnuson-Moss Warranty Act, 15 U.S.C. sec. 2301 et seq. If you choose to seek redress by pursuing rights and remedies not created by California Civil Code Section 1793.22(b) or the Magnuson-Moss Warranty Act, resort to BBB AUTO LINE is not required by those statutes.

THE BETTER BUSINESS BUREAU (BBB) AUTO LINE PROGRAM (U.S. ONLY)

Your satisfaction is important to Ford Motor Company and to your dealer. If a warranty concern has not been resolved using the three-step procedure outlined earlier in this chapter in the Getting the Services you need section, you may be eligible to participate in the BBB AUTO LINE program.

The BBB AUTO LINE program consists of two parts – mediation and arbitration. During mediation, a representative of the BBB will contact both you and Ford Motor Company to explore options for settlement of the claim. If an agreement is not reached during mediation or you do not want to participate in mediation, and if your claim is eligible, you may participate in the arbitration process. An arbitration hearing will be scheduled so that you can present your case in an informal setting before an impartial person. The arbitrator considers the testimony provided and makes a decision after the hearing.

Disputes submitted to the BBB AUTO LINE program are usually decided within 40 days after you file your claim with the BBB. You are not bound by the decision, and may reject the decision and proceed to court where all findings of the BBB Auto Line dispute, and decision, are admissible in the court action. Should you choose to accept the BBB AUTO LINE decision, Ford is then bound by the decision, and must comply with the decision within 30 days of receipt of your acceptance letter.

BBB AUTO LINE Application: Using the information that follows, please call or write to request a program application. You will be asked for your name and address, general information about your new vehicle, information about your warranty concerns, and any steps you have already taken to try to resolve them. A Customer Claim Form will be mailed that needs to be completed, signed and returned to the BBB along with proof of ownership. Upon receipt, the BBB reviews the claim for eligibility under the Program Summary Guidelines.

You can get more information by calling BBB AUTO LINE at 1-800-955-5100, or writing to:

**BBB AUTO LINE a Division of BBB National Programs, Inc.
1676 International Drive, Suite 550
McLean, VA 22102**

BBB AUTO LINE applications can also be requested by calling the Ford Motor Company Customer Relationship Center at 1-800-392-3673.

For additional information, refer to the Better Business Bureau website.

Note: *Ford Motor Company reserves the right to change eligibility limitations, modify procedures, or to discontinue this process at any time without notice and without obligation.*

Customer Assistance

GETTING ASSISTANCE OUTSIDE THE U.S. AND CANADA

Before exporting your vehicle to a foreign country, contact the appropriate foreign embassy or consulate. These officials can inform you of local vehicle registration regulations and where to find unleaded fuel or petrol/gas engines or the proper sulfur fuel for diesel engines.

If you cannot find the proper fuel recommended for your vehicle, contact our Customer Relationship Center.

The use of improper fuels in your vehicle without proper conversion may damage the effectiveness of your emission control system and may cause engine knocking or serious engine damage. Ford Motor Company or Ford of Canada is not responsible for any damage caused by use of improper fuel. Using improper fuels may also result in difficulty importing your vehicle back into the United States.

If your vehicle must be serviced while you are traveling or living in Asia-Pacific Region, Sub-Saharan Africa, U.S. Virgin Islands and/or Puerto Rico, Central America, the Caribbean, and Israel and the Middle East, contact the nearest authorized dealer. If the authorized dealer cannot help you, contact the corresponding Ford Customer Assistance Center:

FORD MOTOR COMPANY

Customer Relationship Centers in:

Customer Relationship Center	Phone	Fax	E-mail
Asia Pacific	N/A	N/A	apemcrc@ford.com
Caribbean and Central America	+1-800-841-3673	N/A	atnclien@ford.com
Middle East	Ford 80004443673	971 4 3327 266	menacac@ford.com
	Lincoln 80004441067		
	UAE 80004441066		
	Saudi Arabia 8008443673		
	Mobily and Zain cell phone users in Saudi 800850078		
Kuwait 22280384			

Customer Assistance

Customer Relationship Center	Phone	Fax	E-mail
North Africa	N/A	N/A	nafcrc@ford.com
Puerto Rico and U.S. Virgin Islands	+1-800-841-3673	N/A	atnclien@ford.com
Sub-Saharan Africa	N/A	N/A	ssacrc@ford.com
South Korea	+82-02-1600-6003	N/A	infokr1@ford.com or infokr@lincoln.com

If you buy your vehicle in North America and then relocate to any of the above locations, register your vehicle identification number (VIN) and new address with Ford Global Trade Services by emailing, expcso@ford.com.

If you are in another foreign country, contact the nearest authorized dealer. In the event your inquiry is unresolved, communicate your concern with the dealership's Sales Manager, Service Manager or Customer Relations Manager. If you require additional assistance or clarification, please contact the respective Customer Relationship Center as previously listed.

Customers in the U.S. should call 1-800-392-3673.

ORDERING ADDITIONAL OWNER'S LITERATURE

To order the publications in this portfolio, contact Helm, LLC at:

HELM, LLC
47911 Halyard Drive, Suite 200
Plymouth, Michigan 48170
Attention: Customer Service

Or to order a free publication catalog, call toll free: 1-800-782-4356

Monday-Friday 8:00 a.m. - 6:00 p.m. EST

Helm, LLC can also be reached by their website:

www.helminc.com

(Items in this catalog may be purchased by credit card, check or money order.)

Obtaining a French Owner's Manual

French Owner's Manual can be obtained from your authorized dealer or by contacting Helm, LLC using the contact information listed previously in this section.

REPORTING SAFETY DEFECTS (U.S. ONLY)

If you believe that your vehicle has a defect which could cause a crash or could cause injury or death, you should immediately inform the National Highway Traffic Safety Administration (NHTSA) in addition to notifying Ford Motor Company.

Customer Assistance

If NHTSA receives similar complaints, it may open an investigation, and if it finds that a safety defect exists in a group of vehicles, it may order a recall and remedy campaign. However, NHTSA cannot become involved in individual problems between you, your dealer, or Ford Motor Company.

To contact NHTSA, you may call the Vehicle Safety Hotline toll-free at 1-888-327-4236 (TTY: 1-800-424-9153); go to www.safercar.gov; or write to:

Administrator

1200 New Jersey Avenue,
Southeast

Washington, D.C. 20590

You can also obtain other information about motor vehicle safety from www.safercar.gov.

REPORTING SAFETY DEFECTS (CANADA ONLY)

If you believe that your vehicle has a defect which could cause a crash or could cause injury or death, you should immediately inform Transport Canada and Ford of Canada.

Transport Canada Contact Information	
Website (English)	http://tc.canada.ca/recalls
Website (French)	http://tc.canada.ca/rappels
Phone	1-800-333-0510

Ford of Canada Contact Information	
Website	www.ford.ca
Phone	1-800-565-3673

Fuses

FUSE SPECIFICATION CHART

Engine Compartment Fuse Box



WARNING: Always disconnect the battery before servicing high current fuses.



WARNING: To reduce risk of electrical shock, always replace the cover to the power distribution box before reconnecting the battery or refilling fluid reservoirs.

The engine compartment fuse box is in the engine compartment. It has high-current fuses that protect your vehicle's main electrical systems from overloads.

If you disconnect and reconnect the battery, you need to reset some features. See **Changing the 12V Battery** (page 124).

Replace fuses with the same type and rating. See **Changing a Fuse** (page 108).

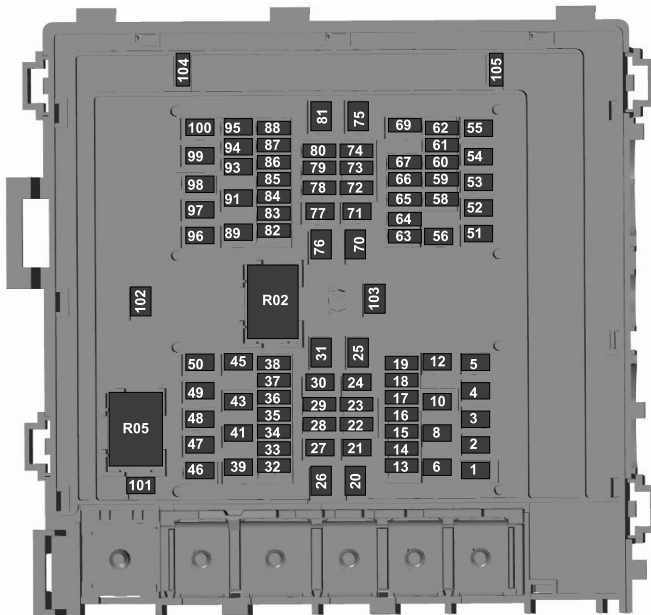

E251921

Fuses

Fuse Number	Fuse Rating	Protected Component
1	20 A	Horn.
2	50 A	Blower motor.
3	—	Not used.
4	30 A	Starter relay.
5	—	Not used.
6	—	Not used.
8	—	Not used.
10	—	Not used.
12	—	Not used.
13	10 A	Run/start feed climate controls. Climate control blower motor relay.
14	10 A	Adaptive cruise control relay.
15	—	Not used.
16	—	Not used.
17	10 A	Powertrain control module run/start feed.
18	10 A	Anti-lock brake system run/start feed.
19	—	Not used.
20	40 A	Wiper power.
21	—	Not used.
22	10 A	Wiper module.
23	—	Not used.
24	40 A	Body control module - battery power in feed 2.
25	50 A	Body control module - battery power in feed 1.

Fuses

Fuse Number	Fuse Rating	Protected Component
26	—	Not used.
27	20 A	B+ to body builder connector.
28	—	Not used.
29	—	Not used.
30	—	Not used.
31	60 A	Hydromax pump relay.
32	20 A	Vehicle power 1.
33	20 A	Vehicle power 2.
34	10 A	Vehicle power 3.
35	20 A	Vehicle power 4.
36	—	Not used.
37	—	Not used.
38	10 A	Wiper washer.
39	—	Not used.
41	30 A	Trailer brake control connector.
43	30 A	B+ to body builder connector.
45	—	Not used.
46	10 A	A/C clutch.
47	—	Not used.
48	20 A	Run/accessory to body builder connector.
49	30 A	Pump electronics module.
50	15 A	Injector.
51	20 A	Auxiliary power point.
52	—	Not used.

Fuses

Fuse Number	Fuse Rating	Protected Component
53	30 A	Trailer tow parking lamps.
54	—	Not used.
55	—	Not used.
56	20 A	Auxiliary power point.
58	5 A	USB smart charger.
59	10 A	U-Haul parking lamp 1 (special order vehicles).
60	—	Not used.
61	—	Not used.
62	—	Not used.
63	—	Not used.
64	—	Not used.
65	—	Not used.
66	—	Not used.
67	10 A	Brake on-off isolation relay.
69	—	Not used.
70	—	Not used.
71	30 A	Anti-lock brake system valves.
72	—	Not used.
73	—	Not used.
74	—	Not used.
75	—	Not used.
76	60 A	B+ to body control module.
77	30 A	Voltage quality module power - body control module.
78	10 A	Trailer tow stoplamps.

Fuses

Fuse Number	Fuse Rating	Protected Component
79	5 A	Hydromax pump monitor.
80	10 A	Trailer tow backup lamps.
81	—	Not used.
82	—	Not used.
83	—	Not used.
84	—	Not used.
85	—	Not used.
86	—	Not used.
87	—	Not used.
88	—	Not used.
89	—	Not used.
91	40 A	B+ to body builder connector.
93	—	Not used.
94	—	Not used.
95	20 A	Stop lamp relay. Trailer brake controller.
96	—	Not used.
97	50 A	Not used (spare).
98	30 A	Trailer tow battery charge.
99	40 A	Upfitter run/start feed.
100	—	Not used.
101	—	Not used.
102	—	Not used.
103	—	Not used.

Fuses

Fuse Number	Fuse Rating	Protected Component
104	—	Not used.
105	15 A	Trailer tow right-hand and left-hand stop and direction indicator relay power.

Note: Spare fuse amperage may vary.

Relay Number	Fuse Rating	Protected Component
R02	—	Not used.
R05	—	Not used.

Passenger Compartment Fuse Box



WARNING: Always disconnect the battery before servicing high current fuses.

Note: If your vehicle has dual batteries, disconnecting the primary underhood battery does not remove power from all circuits.

This fuse panel is below and to the left-hand side of the steering wheel near the brake pedal. Remove the panel cover to access the fuses.

Use a fuse puller tool to remove a fuse.

Replace fuses with the same type and rating. See **Changing a Fuse** (page 108).

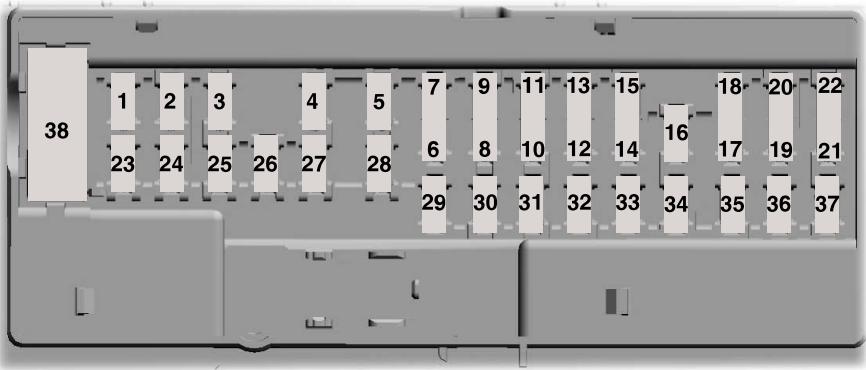

Fuses

Fuse Number	Fuse Rating	Protected Component
1	—	Not used.
2	10 A	Run/accessory radio feed to body builder.
3	—	Not used.
4	20 A	B+ feed to body builder connector.
5	—	Not used.
6	10 A	Not used.
7	10 A	Smart datalink connector.
8	—	Not used.
9	—	Not used.
10	—	Not used.
11	—	Not used.
12	7.5 A	Brake on-off switch.
13	7.5 A	Smart datalink connector.
14	15 A	Not used (spare).
15	15 A	Not used (spare).
16	—	Not used.
17	7.5 A	Not used.
18	7.5 A	Yaw sensor.
19	5 A	Telematics control unit module.
20	5 A	Ignition switch.
21	5 A	Not used.
22	5 A	Not used (spare).
23	30 A	Not used (spare).
24	30 A	Not used (spare).
25	20 A	Not used (spare).

Fuses

Fuse Number	Fuse Rating	Protected Component
26	30 A	Not used (spare).
27	30 A	Not used (spare).
28	30 A	Not used (spare).
29	15 A	Not used (spare).
30	5 A	Brake on-off isolation relay to hydromax relay and hydromax monitor.
31	10 A	Instrument cluster. Steering column control module.
32	20 A	Not used (spare).
33	—	Not used.
34	30 A	Not used (spare).
35	5 A	Tow haul switch.
36	15 A	Camera lane departure warning.
37	20 A	Run/start feed.
38	30 A	Not used (spare).

Note: Spare fuse amperage may vary.

CHANGING A FUSE

Fuses



WARNING: Always replace a fuse with one that has the specified amperage rating. Using a fuse with a higher amperage rating can cause severe wire damage and could start a fire.

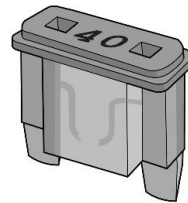

E217331

If electrical components in the vehicle are not working, a fuse may have blown. Blown fuses are identified by a broken wire within the fuse. Check the appropriate fuses before replacing any electrical components.

Fuses

Fuse Types

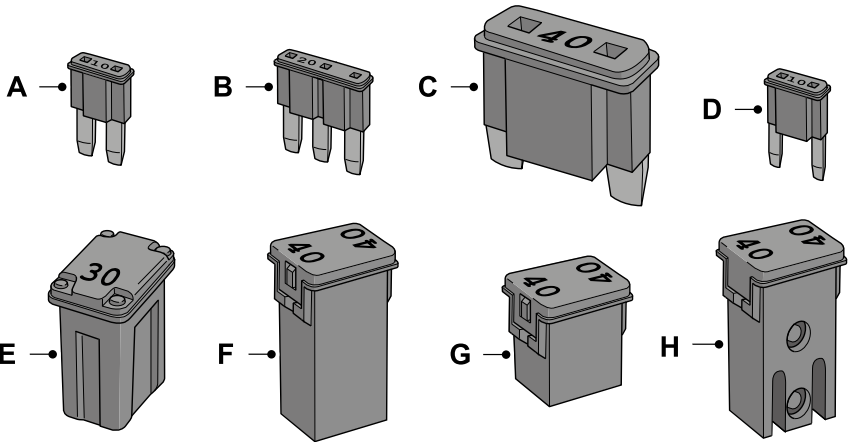

- A Micro 2.
- B Micro 3.
- C Maxi.
- D Mini.
- E M Case.
- F J Case.
- G J Case Low Profile.
- H Slotted M Case.

Maintenance

GENERAL INFORMATION

Have your vehicle serviced regularly to help maintain its roadworthiness and resale value. There is a large network of authorized dealers that are there to help you with their professional servicing expertise. We believe that their specially trained technicians are best qualified to service your vehicle properly and expertly. They are supported by a wide range of highly specialized tools developed specifically for servicing your vehicle.

If your vehicle requires professional service, an authorized dealer can provide the necessary parts and service. Check your warranty information to find out which parts and services are covered.

Use only recommended fuels, lubricants, fluids and service parts conforming to specifications. Motorcraft® parts are designed and built to provide the best performance in your vehicle.

Precautions

- Do not work on a hot engine.
- Make sure that nothing gets caught in moving parts.

- Do not work on a vehicle with the engine running in an enclosed space, unless you are sure you have enough ventilation.
- Keep all open flames and other burning material (such as cigarettes) away from the battery and all fuel related parts.

Working with the Engine Off

1. Set the parking brake and shift the transmission to park (P).
2. Switch off the engine.
3. Block the wheels.

Working with the Engine On



WARNING: To reduce the risk of vehicle damage and personal burn injuries, do not start your engine with the air cleaner removed and do not remove it while the engine is running.

1. Set the parking brake and shift the transmission to park (P).
2. Block the wheels.

Maintenance

UNDER HOOD OVERVIEW - COMMERCIAL CHASSIS

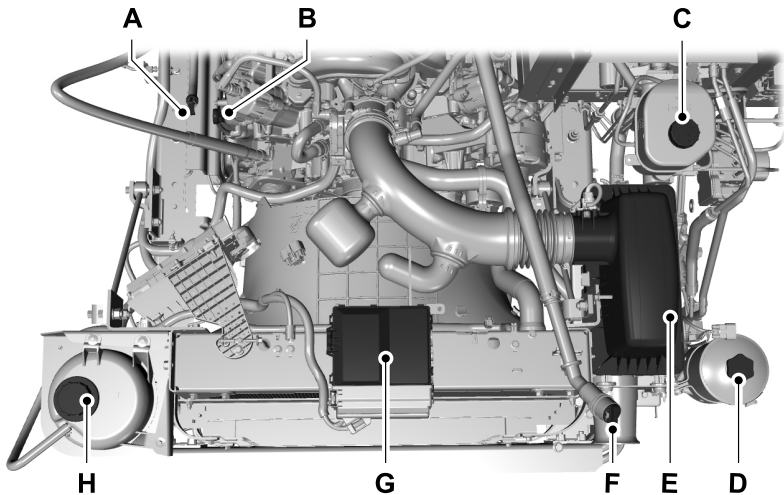

- A Automatic transmission fluid dipstick. See **Automatic Transmission Fluid Check** (page 119).
- B Engine oil dipstick. See **Engine Oil Check** (page 113).
- C Brake fluid reservoir. See **Brake Fluid Check** (page 121).
- D Power steering fluid reservoir. See **Power Steering Fluid Check** (page 122).
- E Air filter assembly. See **Changing the Engine Air Filter** (page 114).
- F Engine oil filler cap. See **Engine Oil Check** (page 113).
- G Engine compartment fuse box. See **Fuses** (page 101).
- H Engine coolant reservoir. See **Engine Coolant Check** (page 115).

Maintenance

UNDER HOOD OVERVIEW - MOTORHOME CHASSIS

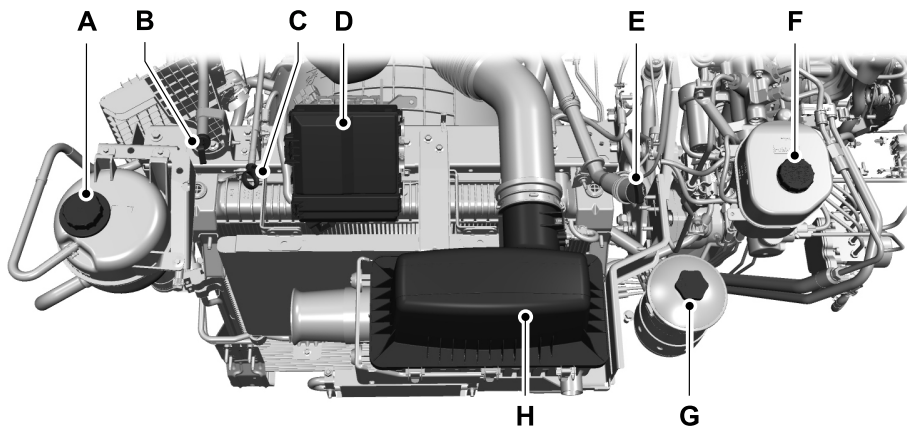

- A Engine coolant reservoir. See **Engine Coolant Check** (page 115).
- B Automatic transmission fluid dipstick. See **Automatic Transmission Fluid Check** (page 119).
- C Engine oil dipstick. See **Engine Oil Check** (page 113).
- D Engine compartment fuse box. See **Fuses** (page 101).
- E Engine oil filler cap. See **Engine Oil Check** (page 113).
- F Brake fluid reservoir. See **Brake Fluid Check** (page 121).
- G Power steering fluid reservoir. See **Power Steering Fluid Check** (page 122).
- H Air filter assembly. See **Changing the Engine Air Filter** (page 114).

Maintenance

ENGINE OIL DIPSTICK

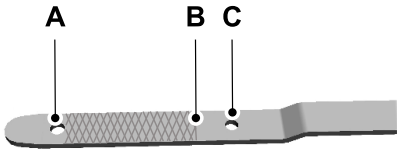

- A Minimum.
- B Nominal.
- C Maximum.

ENGINE OIL CHECK

1. Make sure that your vehicle is on level ground.
2. Check the oil level before starting the engine, or switch the engine off after warm up and wait 15 minutes for the oil to drain into the oil pan.

Note: *Checking the oil level too soon could result in an inaccurate reading.*

3. Remove the dipstick and wipe it with a clean, lint-free cloth.
4. Reinstall the dipstick and make sure it is fully seated.
5. Remove the dipstick again to check the oil level.

Note: *If the oil level is between the maximum and minimum marks, the oil level is acceptable. Do not add oil.*

6. If the oil level is at the minimum mark, immediately add oil.
7. Reinstall the dipstick. Make sure it is fully seated.

Note: *The oil consumption of new engines reaches its normal level after approximately 3,000 mi (5,000 km).*

Note: *Increases in oil level can occur from frequent short trips that do not allow the engine to get to operating temperature, as well as frequent idling or low speed driving for long periods of time.*

Note: *If oil levels are continuously noted above the maximum mark, schedule a visit to your authorized dealer.*

Adding Engine Oil

 **WARNING:** Do not add engine oil when the engine is hot. Failure to follow this instruction could result in personal injury.

 **WARNING:** Do not remove the filler cap when the engine is running.

Do not use supplemental engine oil additives because they are unnecessary and could lead to engine damage that the vehicle warranty may not cover.

1. Clean the area surrounding the engine oil filler cap before you remove it.
2. Remove the engine oil filler cap.
3. Add engine oil that meets our specifications. See **Capacities and Specifications** (page 153).
4. Reinstall the engine oil filler cap. Turn it clockwise until you feel a strong resistance.

Note: *Make sure you install the oil filler cap correctly.*

Note: *Do not add oil further than the maximum mark. Oil levels above the maximum mark may cause engine damage.*

Note: *Immediately soak up any oil spillage with an absorbent cloth.*

Maintenance

OIL CHANGE INDICATOR RESET

2.3 Inch Display

Use the information display controls on the steering wheel to reset the oil change indicator.

From the main menu scroll to:

Message	Action and Description
Driver Assist	Press the right arrow button, then from this menu scroll down to the following message.
Maint. Monitor	Press the right arrow button, then from this menu scroll down to the following message.
Oil Life % Hold to Reset	Press and hold the OK button until the instrument cluster displays the following message. Reset Complete If the instrument cluster displays the following message, repeat the process. Reset Cancelled

8 Inch Display

Use the information display controls on the steering wheel to reset the oil change indicator.

From the main menu scroll to:

Message	Action and Description
Vehicle Info	Press the down arrow button, then from this menu scroll to the following message.
Maintenance Monitor	Press the OK button.
Oil Life: xxx%	Press the down arrow button, then from this menu scroll to the following message.
Oil Life	Press the OK button.
Oil Life Hold OK to Reset	Press and hold the OK button until the instrument cluster displays the following message. Oil Life: 100% When the oil change indicator resets, the instrument cluster displays 100%. Repeat the process if the oil change indicator does not reset.

CHANGING THE ENGINE AIR FILTER



WARNING: To reduce the risk of vehicle damage and personal burn injuries, do not start your engine with the air cleaner removed and do not remove it while the engine is running.

Change the air filter element at the proper interval. See **Scheduled Maintenance** (page 165).

Maintenance

When changing the air filter element, use only the air filter element listed. See **Capacities and Specifications** (page 149).

Note: Failure to use the correct air filter element may result in severe engine damage. The customer warranty may be void for any damage to the engine if you do not use the correct air filter element.

Note: It may be necessary to loosen the worm gear clamp connecting the air cleaner to the clean air duct, disconnect the duct from the air cleaner, disconnect the mass air flow sensor electrical wiring harness connector from the cover, and partially dismount the air cleaner cover and tray from the rubber grommets on the bracket to service the air cleaner.

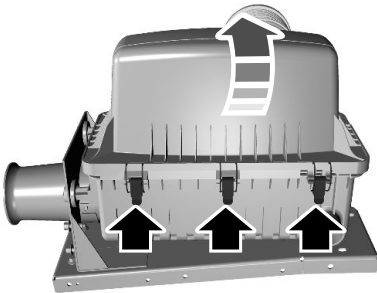

1. Loosen the latches that secure the air filter cover in place.
2. Carefully separate the two halves of the air filter housing.
3. Remove the air filter element from the housing.
4. Wipe any dirt or debris from the air filter housing and cover.

5. Install a new air filter element.
6. Replace the air filter cover to the housing and secure the latches. Be careful not to crimp the filter element edges between the air filter housing. This could cause filter damage and allow unmetered air to enter the engine if not properly seated.

ENGINE COOLANT CHECK

WARNING: Do not remove the coolant reservoir cap when the engine is on or the cooling system is hot. Wait 10 minutes for the cooling system to cool down. Cover the coolant reservoir cap with a thick cloth to prevent the possibility of scalding and slowly remove the cap. Failure to follow this instruction could result in personal injury.

WARNING: To reduce the risk of personal injury, make sure the engine is cool before unscrewing the coolant pressure relief cap. The cooling system is under pressure. Steam and hot liquid can come out forcefully when you loosen the cap slightly.

When the engine is cold, check the concentration and level of the coolant at the intervals listed in the scheduled maintenance information. See **Scheduled Maintenance** (page 165).

Note: Make sure that the coolant level is between the **MIN** and the **MAX** marks on the coolant reservoir.

Note: Coolant expands when it is hot. The level may extend beyond the **MAX** mark.

Maintenance

Maintain coolant concentration within 48% to 50%, which equates to a freeze point between -29°F (-34°C) and -35°F (-37°C). Check coolant concentration using a refractometer. We do not recommend the use of hydrometers or coolant test strips for measuring coolant concentration.

Adding Coolant



WARNING: Do not put coolant in the windshield washer reservoir. If sprayed on the windshield, coolant could make it difficult to see through the windshield.



WARNING: Do not add coolant further than the **MAX** mark.



WARNING: Do not remove the coolant reservoir cap when the engine is on or the cooling system is hot. Wait 10 minutes for the cooling system to cool down. Cover the coolant reservoir cap with a thick cloth to prevent the possibility of scalding and slowly remove the cap. Failure to follow this instruction could result in personal injury.

Note: *Automotive fluids are not interchangeable. Take care not to put engine coolant in the windshield washer fluid reservoir or windshield washer fluid in the engine coolant reservoir.*

Note: *Do not use stop leak pellets, cooling system sealants, or non-specified additives as they can cause damage to the engine cooling or heating systems. Resulting component damage may not be covered by the vehicle Warranty.*

It is very important to use prediluted coolant approved to the correct specification in order to avoid plugging the small passageways in the engine cooling system. See **Capacities and Specifications** (page 149). Do not mix different colors or types of coolant in your vehicle. Mixing of engine coolants or using an incorrect coolant could harm the engine or cooling system components and may not be covered by the vehicle Warranty.

Note: *If prediluted coolant is not available, use the approved concentrated coolant diluting it to 50/50 with deionized or distilled water. See **Capacities and Specifications** (page 149). Using water that has not been deionized may contribute to deposit formation, corrosion and plugging of the small cooling system passageways.*

Note: *Coolants marketed for all makes and models may not be approved to our specifications and could cause damage to the cooling system. Resulting component damage may not be covered by the vehicle Warranty.*

If the coolant level is at or below the minimum mark, add prediluted coolant immediately.

To top up the coolant level do the following:

1. Unscrew the cap slowly. Any pressure escapes as you unscrew the cap.
2. Add prediluted coolant approved to the correct specification. See **Capacities and Specifications** (page 149).
3. Add enough prediluted coolant to reach the correct level.
4. Replace the coolant reservoir cap, turn it clockwise until you feel a strong resistance.

Maintenance

5. Check the coolant level in the coolant reservoir the next few times you drive your vehicle. If necessary, add enough prediluted engine coolant to bring the coolant level to the correct level.

If you have to add more than 1.1 qt (1 L) of engine coolant per month, have your vehicle checked as soon as possible. Operating an engine with a low level of coolant can result in engine overheating and possible engine damage.

Note: *During normal vehicle operation, the coolant may change color from orange to pink or light red. As long as the coolant is clear and uncontaminated, this color change does not indicate the coolant has degraded nor does it require the coolant to be drained, the system to be flushed, or the coolant to be replaced.*

In case of emergency, you can add a large amount of water without engine coolant in order to reach a vehicle service location. In this instance, qualified personnel must:

- Drain the cooling system.
- Chemically clean the cooling system.
- Refill with engine coolant.

Water alone, without engine coolant, can cause engine damage from corrosion, overheating or freezing.

Do not use the following as a coolant substitute:

- Alcohol.
- Methanol.
- Brine.
- Any coolant mixed with alcohol or methanol antifreeze.

Alcohol and other liquids can cause engine damage from overheating or freezing.

Do not add extra inhibitors or additives to the coolant. These can be harmful and compromise the corrosion protection of the coolant.

Recycled Coolant

We do not recommend the use of recycled coolant as an approved recycling process is not yet available.

Dispose of used engine coolant in an appropriate manner.

Follow your community's regulations and standards for recycling and disposing of automotive fluids.

Severe Climates

If you drive in extremely cold climates:

- It may be necessary to increase the coolant concentration above 50%.
- A coolant concentration of 60% provides improved freeze point protection. Coolant concentrations above 60% decrease the overheat protection characteristics of the coolant and could cause engine damage.

If you drive in extremely hot climates:

- You can decrease the coolant concentration to 40%.
- Coolant concentrations below 40% decrease the freeze and corrosion protection characteristics of the coolant and could cause engine damage.

Use prediluted coolant in vehicles driven year-round in non-extreme climates for optimum cooling system and engine protection.

Coolant Change

Change the coolant at specific mileage intervals, as listed in the scheduled maintenance information. Add prediluted coolant approved to the correct specification. See **Capacities and Specifications** (page 149).

Maintenance

Fail-Safe Cooling

Fail-safe cooling allows you to temporarily drive your vehicle before any incremental component damage occurs. The fail-safe distance depends on ambient temperature, vehicle load and terrain.

How Fail-Safe Cooling Works



If the engine begins to overheat, the coolant temperature gauge moves toward the red zone:



A warning lamp illuminates and a message may appear in the information display.

If the engine reaches a preset over-temperature condition, the engine automatically switches to alternating cylinder operation. Each disabled cylinder acts as an air pump and cools the engine.

When this occurs, your vehicle still operates, however:

- Engine power is limited.
- The air conditioning system turns off.

Continued operation increases the engine temperature, causing the engine to completely shut down. Your steering and braking effort increases in this situation.

When the engine temperature cools, you can re-start the engine. Have your vehicle checked as soon as possible to minimize engine damage.

When Fail-Safe Mode Is Activated



WARNING: Fail-safe mode is for use during emergencies only. Operate your vehicle in fail-safe mode only as long as necessary to bring your vehicle to rest in a safe location and seek immediate repairs. When in fail-safe mode, your vehicle will have limited power, will not be able to maintain

high-speed operation, and may completely shut down without warning, potentially losing engine power, power steering assist, and power brake assist, which may increase the possibility of a crash resulting in serious injury.



WARNING: Do not remove the coolant reservoir cap when the engine is on or the cooling system is hot. Wait 10 minutes for the cooling system to cool down. Cover the coolant reservoir cap with a thick cloth to prevent the possibility of scalding and slowly remove the cap. Failure to follow this instruction could result in personal injury.

Your vehicle has limited engine power when in the fail-safe mode, drive your vehicle with caution. Your vehicle does not maintain high-speed operation and the engine may operate poorly.

Remember that the engine is capable of automatically shutting down to prevent engine damage. In this situation:

1. Pull off the road as soon as safely possible and switch the engine off.
2. If you are a member of a roadside assistance program, we recommend that you contact your roadside assistance service provider.
3. If this is not possible, wait a short period for the engine to cool.
4. Check the coolant level. If the coolant level is at or below the minimum mark, add prediluted coolant immediately.
5. When the engine temperature cools, you can re-start the engine. Have your vehicle checked as soon as possible to minimize engine damage.

Note: *Driving your vehicle without repair increases the chance of engine damage.*

Maintenance

Engine Coolant Temperature Management (if Equipped)



WARNING: To reduce the risk of crash and injury, be prepared that the vehicle speed may reduce and the vehicle may not be able to accelerate with full power until the coolant temperature reduces.

If you tow a trailer with your vehicle, the engine could temporarily reach a higher temperature during severe operating conditions, for example ascending a long or steep slope in high ambient temperatures.

At this time, you may notice the coolant temperature gauge moves toward the red zone and a message could appear in the information display.

You may notice a reduction in vehicle speed caused by reduced engine power in order to manage the engine coolant temperature. Your vehicle may enter this mode if certain high-temperature and high-load conditions take place. The amount of speed reduction depends on vehicle loading, slope and ambient temperature. If this occurs, there is no need to pull off the road, you can continue to drive your vehicle.

The air conditioning could turn on and off during severe operating conditions to protect the engine from overheating. When the coolant temperature decreases to the normal operating temperature, the air conditioning turns on.

If the coolant temperature gauge moves fully into the red zone, or if the coolant temperature warning or service engine soon messages appear in your information display, do the following:

1. Pull off the road as soon as safely possible and shift the transmission into park (P).
2. Leave the engine running until the coolant temperature gauge needle returns to the normal position. If the temperature does not drop after several minutes, follow the remaining steps.
3. Switch the engine off and wait for it to cool. Check the coolant level.
4. If the coolant level is at or below the minimum mark, add prediluted coolant immediately.
5. If the coolant level is normal, restart the engine and continue.

AUTOMATIC TRANSMISSION FLUID CHECK



WARNING: The dipstick and surrounding components are hot. Use gloves when moving components and checking the transmission fluid level. Failure to follow this warning could result in serious personal injury.

Note: *Automatic transmission fluid expands when warm. To obtain an accurate fluid check, drive the vehicle until it is at normal operating temperature (approximately 20 mi (30 km)). If your vehicle has been operating for an extended period at high speeds, in city traffic during hot weather or pulling a trailer, turn the vehicle off for about 30 minutes to allow fluid to cool to normal operating temperature 196°F - 215°F (91°C - 102°C) before checking.*

Refer to the scheduled maintenance information for scheduled intervals for fluid checks and changes.

Maintenance

Your transmission does not consume fluid. However, check the fluid level if the transmission is not working properly, (for example, if the transmission slips or shifts slowly) or if you notice some sign of fluid leakage. To check the fluid level:

1. Drive the vehicle 20 mi (30 km) or until it reaches normal operating temperature via the transmission fluid temperature gauge in the instrument cluster, if available
2. Park the vehicle on a level surface and engage the parking brake
3. With the engine running, parking brake engaged and your foot on the brake pedal, move the gearshift lever through all of the gear ranges. Allow sufficient time for each gear to engage.
4. Put the gearshift lever in P (park) and leave the engine running.
5. Remove the dipstick, wiping it clean with a clean, dry lint free rag. If necessary, refer to Under Hood Overview in this chapter for the location of the dipstick.
6. Install the dipstick making sure it is fully seated in the filler tube.
7. Remove the dipstick and inspect the fluid level. The fluid should be in the designated area for normal operating temperature or ambient temperature.

Do not use supplemental transmission fluid additives, treatments or cleaning agents. Using these materials may affect transmission operation and result in damage to internal transmission components.

Low fluid level



E161551

Do not drive the vehicle if there is no indication of fluid on the dipstick and the ambient temperature is above 50°F (10°C).

Correct fluid level



E161552

The transmission fluid should be in this range if at normal operating temperature 196°F - 215°F (91°C - 102°C).

The transmission fluid should be checked at normal operating temperature 196°F - 215°F (91°C - 102°C) on a level surface. The normal operating temperature can be reached after approximately 20 mi (30 km) of driving. If the ambient temperature is above 50°F (10°C), an overfill condition could result when the vehicle reaches normal operating temperature.

Maintenance

High fluid level



E161553

Fluid levels above the safe range may result in transmission failure. An overfill condition of transmission fluid may cause shift and/or engagement concerns and/or possible damage.

An overheating condition can cause high fluid levels.

Adjusting automatic transmission fluid levels

Note: Use of a non-approved automatic transmission fluid may cause internal transmission damage. Before adding any fluid, make sure the correct type is used. The type of fluid used is normally indicated on the transmission dipstick and also in the Owner's Manual. See **Capacities and Specifications** (page 149).



E161554

Add fluid in ½ pint (250 ml) increments through the filler tube until the level is correct.

Note: If an overfill occurs, go to your authorized dealer to have the excess fluid removed. An overfill condition of transmission fluid may cause shift and/or engagement concerns and/or possible damage.

Do not use supplemental transmission fluid additives, treatments or cleaning agents. Using these materials may affect transmission operation and result in damage to internal transmission components.

Automatic transmission fluid filter

The TorqShift6™ automatic transmission is equipped with a serviceable transmission fluid filter located inside the transmission bottom pan. Refer to the scheduled maintenance information for service intervals for the automatic transmission fluid and transmission filter. For transmission filter maintenance, see your authorized dealer.

BRAKE FLUID CHECK





WARNING: Do not use any fluid other than the recommended brake fluid as this will reduce brake efficiency. Use of incorrect fluid could result in the loss of vehicle control, serious personal injury or death.



WARNING: Only use brake fluid from a sealed container. Contamination with dirt, water, petroleum products or other materials may result in brake system damage or failure. Failure to adhere to this warning could result in the loss of vehicle control, serious personal injury or death.

Maintenance

 **WARNING:** Do not allow the fluid to touch your skin or eyes. If this happens, rinse the affected areas immediately with plenty of water and contact your physician.

 **WARNING:** The brake system could be affected if the brake fluid level is below the **MIN** mark or above the **MAX** mark on the brake fluid reservoir.



Only use fluid that meets our specifications. See **Capacities and Specifications** (page 149).

Brake Fluid Service Interval

Brake fluid absorbs water over time which degrades the effectiveness of the brake fluid. Change the brake fluid at the specified intervals to prevent degraded braking performance.

For detailed interval information, see Scheduled Maintenance in your Owner's Manual or your local maintenance guide.

POWER STEERING FLUID CHECK

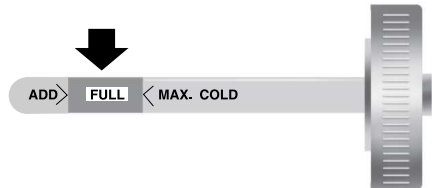
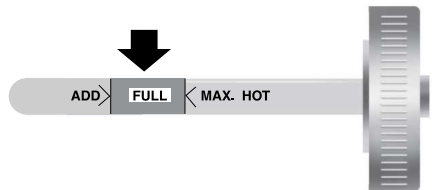

1. Park your vehicle on a level surface.
2. Look at the brake fluid reservoir to see where the brake fluid level is relative to the **MIN** and the **MAX** marks on the reservoir.

Note: If the brake fluid level is between the **MIN** and the **MAX** marks on the reservoir, it is acceptable.

Note: If the brake fluid level is below the **MIN** mark or above the **MAX** mark, have your vehicle checked as soon as possible.

Note: To avoid fluid contamination, the reservoir cap must remain in place and fully tight, unless you are adding fluid.

E161557

Note: The power steering cap has both a cold and hot indicator on the dipstick.

Maintenance

1. Start the engine and let it run until it reaches normal operating temperature (the engine coolant temperature gauge indicator will be near the center of the normal area between H and C).
2. While the engine idles, turn the steering wheel left and right several times.
3. Turn the engine off.
4. Check the fluid level on the dipstick. It should be between the arrows in the FULL range on the side of the dipstick with the words MAX. HOT at the top. Do not add fluid if the level is within this range.
5. If the fluid is low, add fluid in small amounts, continuously checking the level until it reaches the FULL range. Be sure to put the dipstick back in the reservoir.

Steering linkage lubrication points

There are nine lubrication points on the steering linkage: See **Capacities and Specifications** (page 153).

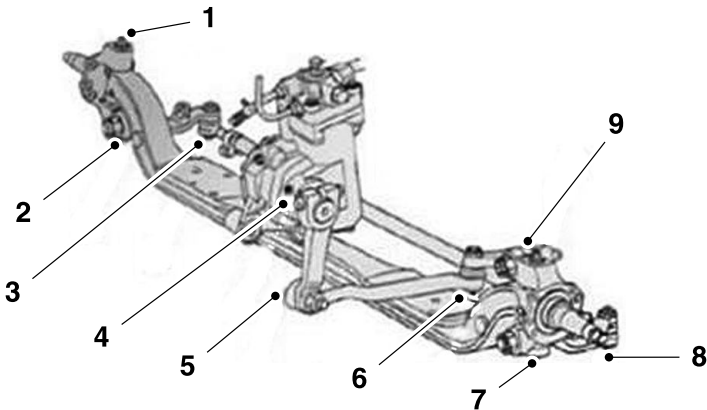

E161558

- **1 and 9** - Top of the kingpin.
- **2 and 7** - Bottom of kingpin.
- **3 and 8** - Right hand and Left hand tie rod end.
- **4** - Steering gear.
- **5 and 6** - Drag link.

Maintenance

CHANGING THE 12V BATTERY



WARNING: Batteries normally produce explosive gases which can cause personal injury. Therefore, do not allow flames, sparks or lighted substances to come near the battery. When working near the battery, always shield your face and protect your eyes. Always provide proper ventilation.



WARNING: When lifting a plastic-cased battery, excessive pressure on the end walls could cause acid to flow through the vent caps, resulting in personal injury and damage to the vehicle or battery. Lift the battery with a battery carrier or with your hands on opposite corners.



WARNING: Keep batteries out of reach of children. Batteries contain sulfuric acid. Avoid contact with skin, eyes or clothing. Shield your eyes when working near the battery to protect against possible splashing of acid solution. In case of acid contact with skin or eyes, flush immediately with water for a minimum of 15 minutes and get prompt medical attention. If acid is swallowed, call a physician immediately.

Note: *If your battery has a cover/shield, make sure it is reinstalled after the battery has been cleaned or replaced.*

Note: *Battery posts, terminals and related accessories contain lead and lead compounds. Wash hands after handling.*

Your vehicle is equipped with a Motorcraft® maintenance-free battery which normally does not require additional water during its life of service.

For longer, trouble-free operation, keep the top of the battery clean and dry. Also, make certain the battery cables are always tightly fastened to the battery terminals.

If you see any corrosion on the battery or terminals, remove the cables from the terminals and clean with a wire brush. You can neutralize the acid with a solution of baking soda and water.

It is recommended that the negative battery cable terminal be disconnected from the battery if you plan to store your vehicle for an extended period of time.

To ensure proper operation of the battery management system (BMS), any electrical devices that are added to the vehicle should not have their ground connection made directly at the negative battery post. A connection at the negative battery post can cause inaccurate measurements of the battery condition and potential incorrect system operation.

Note: *Electrical or electronic accessories or components added to the vehicle by the dealer or the owner may adversely affect battery performance and durability and may also affect the performance of other electrical systems in the vehicle.*

When a battery replacement is required, the battery should only be replaced with a Ford recommended replacement battery that matches the electrical requirements of the vehicle.

Note: *Always dispose of automotive batteries in a responsible manner. Follow your local authorized standards for disposal. Call your local authorized recycling center to find out more about recycling automotive batteries.*

Battery relearn

When the battery is disconnected or a new battery installed:

Maintenance

- The transmission must relearn its adaptive strategy. As a result of this, the transmission may shift firmly. This operation is considered normal and will not affect function or durability of the transmission. Over time the adaptive learning process will fully update transmission operation to its optimum shift feel.
- The clock and the preset radio stations must be reset once the battery is reconnected.
- Your vehicle's engine is electronically controlled by a computer, some control conditions are maintained by power from the battery, the engine must relearn its idle and fuel trim strategy.

When the battery is disconnected or a new battery is installed, begin the battery relearn process:

1. With the vehicle at a complete stop, set the parking brake.
2. Put the gearshift lever in **P** (Park), turn off all accessories and start the engine.
3. Run the engine until it reaches normal operating temperature.
4. Allow the engine to idle for at least one minute.
5. Turn the A/C on and allow the engine to idle for at least one minute.
6. Drive the vehicle to complete the relearning process.
 - The vehicle may need to be driven to relearn the idle and fuel trim strategy.

FUEL FILTER

Your vehicle is equipped with a lifetime fuel filter that is integrated with the fuel tank. Regular maintenance or replacement is not needed.

Vehicle Care

GENERAL INFORMATION

Your dealer has many quality products available to clean your vehicle and protect its finishes.

CLEANING PRODUCTS

Materials

For best results, use the following products or products of equivalent quality:

For additional information and assistance, we recommend that you contact an authorized dealer.

Name	Specification
Motorcraft® Bug and Tar Remover, ZC-42 (U.S. & Canada)	
Motorcraft® Custom Bright Metal Cleaner, ZC-15 (U.S. & Canada)	ESR-M5B194-B
Motorcraft® Detail Wash, ZC-3-A (U.S. & Canada)	ESR-M14P4-A
Motorcraft® Engine Shampoo and Degreaser, ZC-20 (U.S.)	ESR-M14P3-A
Motorcraft® Engine Shampoo, CXC-66-A (Canada)	
Motorcraft® Premium Leather and Vinyl Cleaner, ZC-56 (U.S. & Canada)	
Motorcraft® Multi-Purpose Cleaner, CXC-101 (Canada)	
Motorcraft® Premium Windshield Wash Concentrate with Bitterant, ZC-32-B2 (U.S.)	WSS-M14P19-A
Motorcraft® Premium Quality Windshield Washer Fluid, CXC-37-F/M (Canada)	WSS-M14P19-A
Motorcraft® Professional Strength Carpet & Upholstery Cleaner, ZC-54 (U.S. & Canada)	
Motorcraft® Premium Glass Cleaner, CXC-100 (Canada)	ESR-M14P5-A
Motorcraft® Spot and Stain Remover, ZC-14 (U.S.)	
Motorcraft® Ultra-Clear Spray Glass Cleaner, ZC-23 (U.S.)	ESR-M14P5-A
Motorcraft® Wheel and Tire Cleaner, ZC-37-A (U.S. & Canada)	

Vehicle Care

CLEANING THE EXTERIOR

Wash your vehicle regularly with cool or lukewarm water and a neutral pH shampoo, we recommend Motorcraft Detail Wash.

- Never use strong household detergents or soap, for example dish washing or laundry liquid. These products can discolor and spot painted surfaces.
- Never wash your vehicle when it is hot to the touch, or during strong or direct sunlight.
- Dry your vehicle with a chamois or soft terry cloth towel to eliminate water spotting.
- Immediately remove fuel spillages, bird droppings, insect deposits and road tar. These may cause damage to your vehicle's paintwork or trim over time. We recommend Motorcraft Bug and Tar Remover.
- Remove any exterior accessories, for example antennas, before entering a car wash.
- When filling with AdBlue®, remove any residue on painted surfaces immediately.

Note: *Suntan lotions and insect repellents can damage painted surfaces. If these substances come in contact with your vehicle, wash the affected area as soon as possible.*

Cleaning the Exterior Precautions

Immediately remove fuel spillages, AdBlue residuals, bird droppings, insect deposits and road tar. These may cause damage to your vehicle's paintwork or trim over time.

Remove any exterior accessories, for example antennas, before entering a car wash.

Cleaning the Exterior Lamps

Note: *Do not scrape the exterior lamps lenses or use abrasives, alcoholic solvents or chemical solvents to clean them.*

Note: *Do not wipe the exterior lamps when they are dry.*

Exterior Chrome Parts

- Apply a high quality-cleaning product to bumpers and other chrome parts. Follow the manufacturer's instructions. We recommend Motorcraft Custom Bright Metal Cleaner.
- Do not apply the cleaning product to hot surfaces. Do not leave the cleaning product on chrome surfaces longer than the time recommended.
- Using non-recommended cleaners can result in severe and permanent cosmetic damage.

Note: *Never use abrasive materials, for example steel wool or plastic pads as they can scratch the chrome surface.*

Note: *Do not use chrome cleaner, metal cleaner or polish on wheels or wheel covers.*

Exterior Plastic Parts

For routine cleaning we recommend Motorcraft Detail Wash. If tar or grease spots are present, we recommend Motorcraft Bug and Tar Remover.

Stripes or Graphics (If Equipped)

Hand washing your vehicle is preferred however, pressure washing may be used under the following conditions:

- Do not use water pressure higher than 2,000 psi (14,000 kPa).
- Do not use water hotter than 179°F (82°C).

Vehicle Care

- Use a spray with a 40 degree wide spray angle pattern.
- Keep the nozzle at a 12 in (305 mm) distance and 90 degree angle to your vehicle's surface.

Note: *Holding the pressure washer nozzle at an angle to the vehicle's surface may damage graphics and cause the edges to peel away from the vehicle's surface.*

Underbody

Regularly clean the entire underside of your vehicle. This includes the chassis, body floor sheet metal and wheel wells using fresh water. Keep body and door drain holes free of debris or foreign material.

Under Hood

For removing black rubber marks from under the hood we recommend Motorcraft Wheel and Tire Cleaner or Motorcraft Bug and Tar Remover.

CLEANING THE ENGINE

Engines are more efficient when they are clean because grease and dirt buildup keep the engine warmer than normal.

When washing:

- Take care when using a power washer to clean the engine. The high-pressure fluid could penetrate the sealed parts and cause damage.
- Do not spray a hot engine with cold water to avoid cracking the engine block or other engine components.
- Spray Motorcraft Engine Shampoo and Degreaser on all parts that require cleaning and pressure rinse clean. In Canada, use Motorcraft Engine Shampoo.

Note: *If your vehicle has an engine cover remove the cover before application of Motorcraft Engine Shampoo and Degreaser. Immediately rinse away any over spray.*

- Never wash or rinse the engine while it is hot or running; water in the running engine may cause internal damage.
- Never wash or rinse any ignition coil, spark plug wire or spark plug well, or the area in and around these locations.
- Cover the battery, power distribution box, and air filter assembly to prevent water damage when cleaning the engine.

CLEANING THE WHEELS

1. Regularly clean them with a wheel cleaner. We recommend that you use Ford approved wheel cleaner if available.
2. Remove dirt and brake dust with a sponge.
3. Remove tar and grease with a bug and tar remover. We recommend that you use Ford approved bug and tar remover if available.
4. Thoroughly rinse the wheels with water after cleaning.

If you intend on parking your vehicle for an extended period after cleaning the wheels with a wheel cleaner, drive your vehicle for a few minutes before doing so. This reduces the risk of corrosion of the brake discs, brake pads and linings.

Do not clean the wheels when they are hot.

Note: *Some car washes could damage wheel rims and covers.*

Note: *Using non-recommended cleaners, harsh cleaning products, chrome wheel cleaners or abrasive materials could damage wheel rims, covers and bolts.*

Vehicle Care

VEHICLE STORAGE

If you plan on storing your vehicle for 30 days or more, read the following maintenance recommendations to make sure your vehicle stays in good operating condition.

We engineer and test all motor vehicles and their components for reliable, regular driving. Under various conditions, long-term storage may lead to degraded engine performance or failure unless you use specific precautions to preserve engine components.

General

- Store all vehicles in a dry, ventilated place.
- Protect from sunlight, if possible.
- If vehicles are stored outside, they require regular maintenance to protect against rust and damage.

Body

- Wash your vehicle thoroughly to remove dirt, grease, oil, tar or mud from exterior surfaces, rear-wheel housing and the underside of front fenders.
- Periodically wash your vehicle if it is stored in exposed locations.
- Touch-up exposed or primed metal to prevent rust.
- Cover chrome and stainless steel parts with a thick coat of auto wax to prevent discoloration. Re-wax as necessary when you wash your vehicle.
- Lubricate all hood, door and luggage compartment hinges and latches with a light grade oil.
- Cover interior trim to prevent fading.
- Keep all rubber parts free from oil and solvents.

Engine

- Change the engine oil and filter prior to storage because used engine oil contains contaminants which may cause engine damage.
- Start the engine every 15 days for a minimum of 15 minutes. Run at fast idle with the climate controls set to defrost until the engine reaches normal operating temperature.
- With your foot on the brake, shift through all the gears while the engine is running.
- We recommend that you change the engine oil before you use your vehicle again.

Fuel system

- Fill the fuel tank with high-quality fuel until the first automatic shutoff of the fuel pump nozzle.

Cooling system

- Protect against freezing temperatures.
- When removing your vehicle from storage, check coolant fluid level. Confirm that there are no cooling system leaks and that fluid is at the recommended level.

Disconnecting Your 12 Volt Battery

- Check and recharge as necessary. Keep connections clean.
- If storing your vehicle for more than 30 days without recharging the battery, we recommend that you disconnect the battery cables to maintain battery charge for quick starting.

Note: *It is necessary to reset memory features if you disconnect the battery cables.*

Vehicle Care

Brakes

- Make sure the brakes and parking brake release fully.

Tires

- Maintain recommended air pressure.

Miscellaneous

- Make sure all linkages, cables, levers and pins under your vehicle are covered with grease to prevent rust.
- Move vehicles at least 25 ft (7.5 m) every 15 days to lubricate working parts and prevent corrosion.

Removing Vehicle From Storage

When your vehicle is ready to come out of storage, do the following:

- Wash your vehicle to remove any dirt or grease film build-up on window surfaces.
- Check windshield wipers for any deterioration.
- Check under the hood for any foreign material that may have collected during storage such as mice or squirrel nests.
- Check the exhaust for any foreign material that may have collected during storage.
- Check tire pressures and set tire inflation per the Tire Label.
- Check brake pedal operation. Drive your vehicle 15 ft (4.5 m) back and forth to remove rust build-up.
- Check fluid levels (including coolant, oil and gas) to make sure there are no leaks, and fluids are at recommended levels.
- If you remove the battery, clean the battery cable ends and check for damage.

Contact an authorized dealer if you have any concerns or issues.

Wheels and Tires

TIRE CARE

Information About Uniform Tire Quality Grading



Tire Quality Grades apply to new pneumatic passenger car tires. The Quality grades can be found where applicable on the tire sidewall between tread shoulder and maximum section width. For example: **Treadwear 200 Traction AA Temperature A.**

These Tire Quality Grades are determined by standards that the United States Department of Transportation has set.

Tire Quality Grades apply to new pneumatic passenger car tires. They do not apply to deep tread, winter-type snow tires, space-saver or temporary use spare tires, light truck or LT type tires, tires with nominal rim diameters of 10 to 12 inches or limited production tires as defined in Title 49 Code of Federal Regulations Part 575.104 (c)(2).

U.S. Department of Transportation Tire quality grades:

The U.S. Department of Transportation requires Ford Motor Company to give you the following information about tire grades exactly as the government has written it.

Treadwear

The treadwear grade is a comparative rating based on the wear rate of the tire when tested under controlled conditions on a specified government test course. For example, a tire graded 150 would wear 1 ½ times as well on the government course as a tire graded 100. The relative performance of tires depends upon the actual conditions of their use, however, and may depart significantly from the norm due to variations in driving habits, service practices, and differences in road characteristics and climate.

Traction AA A B C



WARNING: The traction grade assigned to this tire is based on straight-ahead braking traction tests, and does not include acceleration, cornering, hydroplaning or peak traction characteristics.

Wheels and Tires

The traction grades, from highest to lowest are AA, A, B, and C. The grades represent the tire's ability to stop on wet pavement as measured under controlled conditions on specified government test surfaces of asphalt and concrete. A tire marked C may have poor traction performance.

Temperature A B C



WARNING: The temperature grade for this tire is established for a tire that is properly inflated and not overloaded. Excessive speed, underinflation, or excessive loading, either separately or in combination, can cause heat buildup and possible tire failure.

The temperature grades are A (the highest), B and C, representing the tire's resistance to the generation of heat and its ability to dissipate heat when tested under controlled conditions on a specified indoor laboratory test wheel. Sustained high temperature can cause the material of the tire to degenerate and reduce tire life, and excessive temperature can lead to sudden tire failure. The grade C corresponds to a level of performance which all passenger car tires must meet under the

Federal Motor Vehicle Safety Standard No. 139. Grades B and A represent higher levels of performance on the laboratory test wheel than the minimum required by law.

Glossary of Tire Terminology

***Tire label:** A label showing the original equipment tire sizes, recommended inflation pressure and the maximum weight the vehicle can carry.

***Tire Identification Number:** A number on the sidewall of each tire providing information about the tire brand and manufacturing plant, tire size and date of manufacture. Also referred to as DOT code.

***Inflation pressure:** A measure of the amount of air in a tire.

***Standard load:** A class of P-metric or Metric tires designed to carry a maximum load at set pressure. For example: For P-metric tires 35 psi (2.4 bar) and for Metric tires 36 psi (2.5 bar). Increasing the inflation pressure beyond this pressure will not increase the tire's load carrying capability.

***Extra load:** A class of P-metric or Metric tires designed to carry a heavier maximum load at 42 psi (2.9 bar). Increasing the inflation pressure beyond this pressure will not increase the tire's load carrying capability.

Wheels and Tires

***kPa:** Kilopascal, a metric unit of air pressure.

***PSI:** Pounds per square inch, a standard unit of air pressure.

***Cold tire pressure:** The tire pressure when the vehicle has been stationary and out of direct sunlight for an hour or more and prior to the vehicle being driven for 1 mile (1.6 kilometers).

***Recommended inflation pressure:** The cold inflation pressure found on the Safety Compliance Certification Label. See the completed vehicle's owner's manual for the location of the Safety Compliance Certification Label.

***Bead area of the tire:** Area of the tire next to the rim.

***Sidewall of the tire:** Area between the bead area and the tread.

***Tread area of the tire:** Area of the perimeter of the tire that contacts the road when mounted on the vehicle.

***Rim:** The metal support (wheel) for a tire or a tire and tube assembly upon which the tire beads are seated.

Information Contained on the Tire Sidewall

Both United States and Canada Federal regulations require tire manufacturers to place standardized information on the sidewall of all tires. This information identifies and describes the fundamental characteristics of the tire and also provides a U.S. DOT Tire Identification Number for safety standard certification and in case of a recall.

Information on P Type Tires

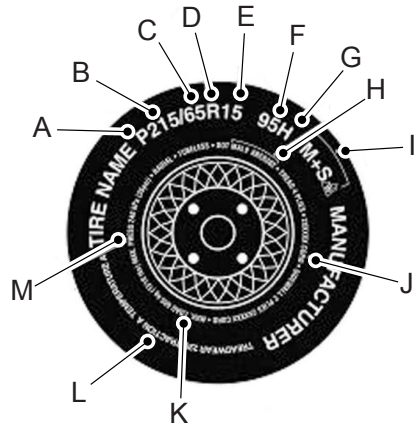

P215/65R15 95H is an example of a tire size, load index and speed rating. The definitions of these items are listed below. (Note that the tire size, load index and speed rating for your vehicle may be different from this example.)

Wheels and Tires

A. **P:** Indicates a tire, designated by the Tire and Rim Association, that may be used for service on cars, sport utility vehicles, minivans and light trucks. **Note:** If your tire size does not begin with a letter this may mean it is designated by either the European Tire and Rim Technical Organization or the Japan Tire Manufacturing Association.

B. **215:** Indicates the nominal width of the tire in millimeters from sidewall edge to sidewall edge. In general, the larger the number, the wider the tire.

C. **65:** Indicates the aspect ratio which gives the tire's ratio of height to width.

D. **R:** Indicates a radial type tire.

E. **15:** Indicates the wheel or rim diameter in inches. If you change your wheel size, you will have to purchase new tires to match the new wheel diameter.

F. **95:** Indicates the tire's load index. It is an index that relates to how much weight a tire can carry. You may find this information in your owner's manual. If not, contact a local tire dealer.

Note: *You may not find this information on all tires because it is not required by federal law.*

G. **H:** Indicates the tire's speed rating. The speed rating denotes the speed at which a tire is designed to be driven for extended periods of time under a standard condition of load and inflation pressure. The tires on your vehicle may operate at different conditions for load and inflation pressure. These speed ratings may need to be adjusted for the difference in conditions. The ratings range from 81 mph (130 km/h) to 186 mph (299 km/h). These ratings are listed in the following chart.

Note: *You may not find this information on all tires because it is not required by federal law.*

Letter rating	Speed rating - mph (km/h)
M	81 (130)
N	87 (140)
Q	99 (159)
R	106 (171)
S	112 (180)
T	118 (190)
U	124 (200)
H	130 (210)
V	149 (240)

Wheels and Tires

Letter rating	Speed rating - mph (km/h)
W	168 (270)
Y	186 (299)

Note: For tires with a maximum speed capability over 149 mph (240 km/h), tire manufacturers sometimes use the letters ZR. For those with a maximum speed capability over 186 mph (299 km/h), tire manufacturers always use the letters ZR.

H. U.S. DOT Tire Identification

Number: This begins with the letters DOT and indicates that the tire meets all federal standards. The next two numbers or letters are the plant code designating where it was manufactured, the next two are the tire size code and the last four numbers represent the week and year the tire was built. For example, the numbers 317 mean the 31st week of 1997. After 2000 the numbers go to four digits. For example, 2501 means the 25th week of 2001. The numbers in between are identification codes used for traceability. This information is used to contact customers if a tire defect requires a recall.

I. **M+S or M/S:** Mud and Snow, or

AT: All Terrain, or

AS: All Season.

J. Tire Ply Composition and Material Used:

Indicates the number of plies or the number of layers of rubber-coated fabric in the tire tread and sidewall. Tire manufacturers also must indicate the ply materials in the tire and the sidewall, which include steel, nylon, polyester, and others.

K. **Maximum Load:** Indicates the maximum load in kilograms and pounds that can be carried by the tire. See the Safety Compliance Certification Label for the correct tire pressure for your vehicle. See the completed vehicle's owner's manual for the location of the Safety Compliance Certification Label.

L. Treadwear, Traction and Temperature Grades:

***Treadwear** The treadwear grade is a comparative rating based on the wear rate of the tire when tested under controlled conditions on a specified government test course. For example, a tire graded 150 would wear 1½ times as well on the government course as a tire graded 100.

***Traction:** The traction grades, from highest to lowest are AA, A, B, and C. The grades represent the tire's ability to stop on wet pavement as measured under controlled conditions on specified government test surfaces of asphalt and concrete. A tire marked C may have poor traction performance.

Wheels and Tires

***Temperature:** The temperature grades are A (the highest), B and C, representing the tire's resistance to the generation of heat and its ability to dissipate heat when tested under controlled conditions on a specified indoor laboratory test wheel.

M. Maximum Inflation

Pressure: Indicates the tire manufacturers' maximum permissible pressure or the pressure at which the maximum load can be carried by the tire. This pressure is normally higher than the vehicle manufacturer's recommended cold inflation pressure which can be found on the Safety Compliance Certification Label. See the completed vehicle's owner's manual for the location of the Safety Compliance Certification Label. The cold inflation pressure should never be set lower than the recommended pressure on the vehicle label.

The tire suppliers may have additional markings, notes or warnings such as standard load or radial tubeless.

Additional Information Contained on the Tire Sidewall for LT Type Tires

Note: *Tire Quality Grades do not apply to this type of tire.*

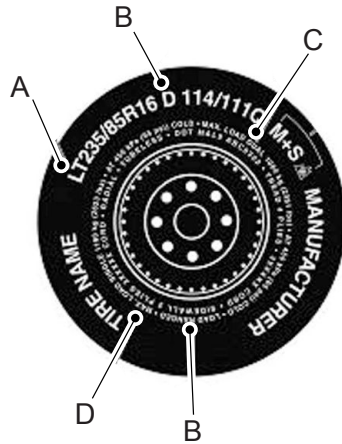

LT type tires have some additional information beyond those of P type tires; these differences are described below.

A. LT: Indicates a tire, designated by the Tire and Rim Association, that is intended for service on light trucks.

B. Load Range and Load Inflation Limits: Indicates the tire's load-carrying capabilities and its inflation limits.

C. Maximum Load Dual lb (kg) at psi (kPa) cold: Indicates the maximum load and tire pressure when the tire is used as a dual; defined as four tires on the rear axle (a total of six or more tires on the vehicle).

Wheels and Tires

D. Maximum Load Single lb (kg) at psi (kPa) cold: Indicates the maximum load and tire pressure when the tire is used as a single; defined as two tires (total) on the rear axle.

Information on T Type Tires

T145/80D16 is an example of a tire size.

Note: *The temporary tire size for your vehicle may be different from this example. Tire Quality Grades do not apply to this type of tire.*

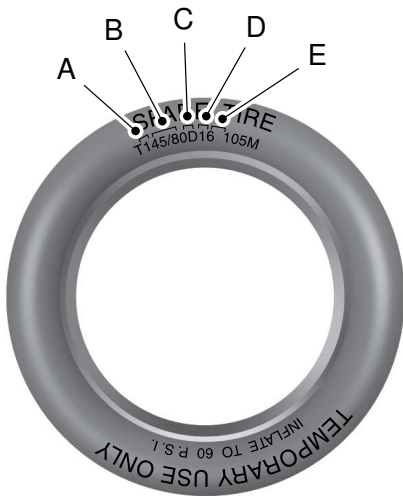

T type tires have some additional information beyond those of P type tires; these differences are described below:

A. T: Indicates a type of tire, designated by the Tire and Rim Association, that is intended for temporary service on cars, sport utility vehicles, minivans and light trucks.

B. 145: Indicates the nominal width of the tire in millimeters from sidewall edge to sidewall edge. In general, the larger the number, the wider the tire.

C. 80: Indicates the aspect ratio which gives the tire's ratio of height to width. Numbers of 70 or lower indicate a short sidewall.

D. D: Indicates a diagonal type tire.

R: Indicates a radial type tire.

E. 16: Indicates the wheel or rim diameter in inches. If you change your wheel size, you will have to purchase new tires to match the new wheel diameter.

Inflating Your Tires

Safe operation of your vehicle requires that your tires are properly inflated. Remember that a tire can lose up to half of its air pressure without appearing flat.

Every day before you drive, check your tires. If one looks lower than the others, use a tire gauge to check pressure of all tires and adjust if required.

Wheels and Tires

At least once a month and before long trips, inspect each tire and check the tire pressure with a tire gauge (including spare, if equipped). Inflate all tires to the inflation pressure recommended by Ford Motor Company.

You are strongly urged to buy a reliable tire pressure gauge, as automatic service station gauges may be inaccurate. Ford recommends the use of a digital or dial-type tire pressure gauge rather than a stick-type tire pressure gauge.

Use the recommended cold inflation pressure for optimum tire performance and wear. Under-inflation or over-inflation may cause uneven treadwear patterns



WARNING: Under-inflation is the most common cause of tire failures and may result in severe tire cracking, tread separation or blowout, with unexpected loss of vehicle control and increased risk of injury. Under-inflation increases sidewall flexing and rolling resistance, resulting in heat buildup and internal damage to the tire. It also may result in unnecessary tire stress, irregular wear, loss of vehicle control and accidents. A tire can lose up to half of its air pressure and not appear to be flat!

Always inflate your tires to the Ford recommended inflation pressure even if it is less than the maximum inflation pressure information found on the tire. The Ford recommended tire inflation pressure is found on the Safety Compliance Certification Label or Tire Label. See the completed vehicle's owner's manual for the location of the Safety Compliance Certification Label or Tire Label. Failure to follow the tire pressure recommendations can cause uneven treadwear patterns and adversely affect the way your vehicle handles

Maximum Inflation Pressure is the tire manufacturer's maximum permissible pressure and the pressure at which the maximum load can be carried by the tire. This pressure is normally higher than the manufacturer's recommended cold inflation pressure which can be found on the Safety Compliance Certification Label or Tire Label. See the completed vehicle's owner's manual for the location of the Safety Compliance Certification Label or Tire Label. The cold inflation pressure should never be set lower than the recommended pressure on the Safety Compliance Certification Label or Tire Label.

Wheels and Tires

When weather temperature changes occur, tire inflation pressures also change. A 10°F (6°C) temperature drop can cause a corresponding drop of 1 psi (7 kPa) in inflation pressure. Check your tire pressures frequently and adjust them to the proper pressure which can be found on the Safety Compliance Certification Label or Tire Label.

To check the pressure in your tire(s):

1. Make sure the tires are cool, meaning they are not hot from driving even a mile.

Note: *If you are checking tire pressure when the tire is hot, (for example, driven more than 1 mile [1.6 kilometers]), never bleed or reduce air pressure. The tires are hot from driving and it is normal for pressures to increase above recommended cold pressures. A hot tire at or below recommended cold inflation pressure could be significantly under-inflated.*

Note: *If you have to drive a distance to get air for your tire(s), check and record the tire pressure first and add the appropriate air pressure when you get to the pump. It is normal for tires to heat up and the air pressure inside to go up as you drive.*

2. Remove the cap from the valve on one tire, then firmly press the tire gauge onto the valve and measure the pressure.

3. Add enough air to reach the recommended air pressure.

Note: *If you overfill the tire, release air by pressing on the metal stem in the center of the valve. Then recheck the pressure with your tire gauge.*

4. Replace the valve cap.
5. Repeat this procedure for each tire, including the spare.

Note: *Some spare tires operate at a higher inflation pressure than the other tires. For T type mini-spare tires, see the Dissimilar spare wheel and tire assembly information for a description. Store and maintain at 60 psi (4.15 bar). For full-size and dissimilar spare tires, see the Dissimilar spare wheel and tire assembly information for a description. Store and maintain at the higher of the front and rear inflation pressure as shown on the Safety Compliance Certification Label or Tire Label.*

6. Visually inspect the tires to make sure there are no nails or other objects embedded that could poke a hole in the tire and cause an air leak.
7. Check the sidewalls to make sure there are no gouges, cuts or bulges.

Wheels and Tires

Tire Inflation Information



WARNING: An inflated tire and rim can be very dangerous if improperly used, serviced or maintained. To reduce the risk of serious injury, never attempt to re-inflate a tire which has been run flat or seriously under-inflated without first removing the tire from the wheel assembly for inspection. Do not attempt to add air to tires or replace tires or wheels without first taking precautions to protect persons and property.

All tires with Steel Carcass Plies (if equipped):

This type of tire utilizes steel cords in the sidewalls. As such, they cannot be treated like normal light truck tires. Tire service, including adjusting tire pressure, must be performed by personnel trained, supervised and equipped according to Federal Occupational Safety and Health Administration regulations. For example, during any procedure involving tire inflation, the technician or individual must utilize a remote inflation device, and ensure that all persons are clear of the trajectory area.

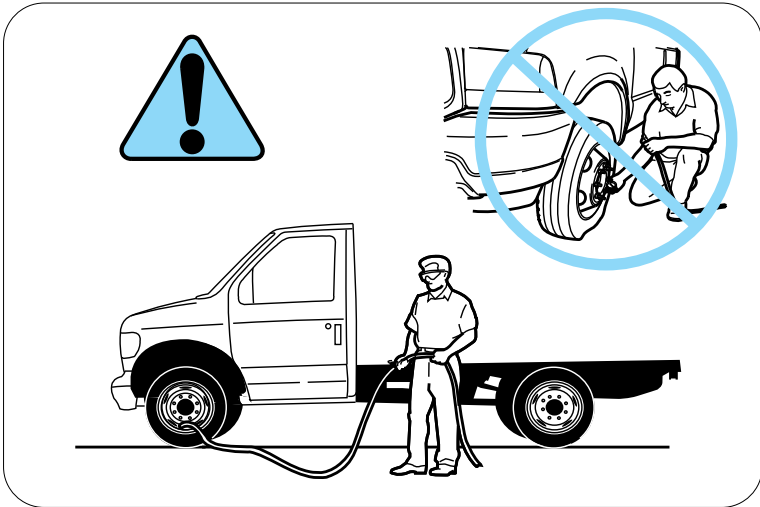

Wheels and Tires

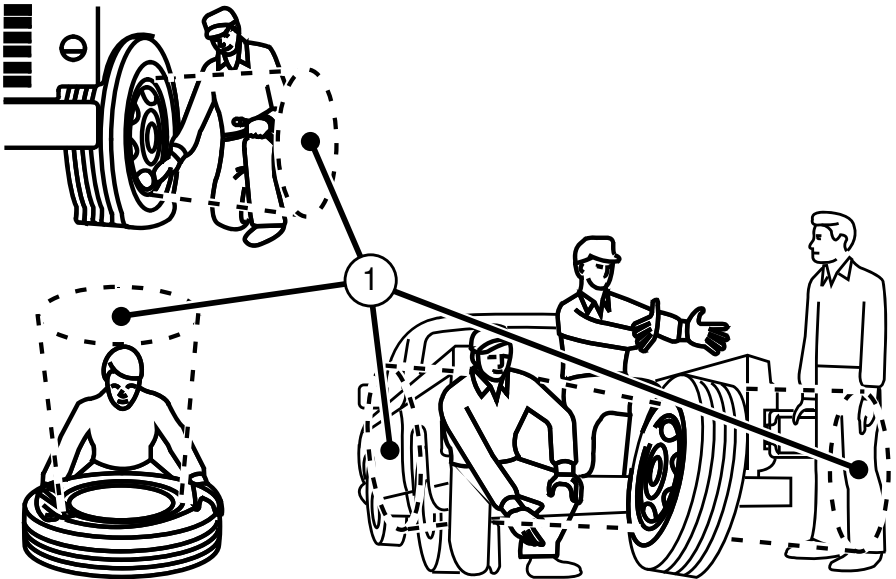

E161438

Stay out of the trajectory (1) as indicated in the illustration.

Inspecting Your Tires and Wheel Valve Stems

Periodically inspect the tire treads for uneven or excessive wear and remove objects such as stones, nails or glass that may be wedged in the tread grooves. Check the tire and valve stems for holes, cracks, or cuts that may permit air leakage and repair or replace the tire and replace the valve stem. Inspect the tire sidewalls for cracking, cuts, bruises and other signs of damage or excessive

wear. If internal damage to the tire is suspected, have the tire demounted and inspected in case it needs to be repaired or replaced. For your safety, tires that are damaged or show signs of excessive wear should not be used because they are more likely to blow out or fail.

Improper or inadequate vehicle maintenance can cause tires to wear abnormally. Inspect all your tires, including the spare, frequently, and replace them if one or more of the following conditions exist:

Wheels and Tires

Tire Wear

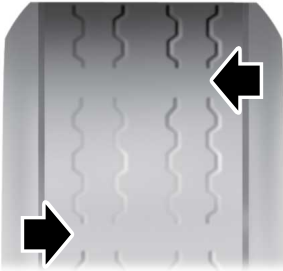

When the tread is worn down to one sixteenth of an inch (2 millimeters), tires must be replaced to help prevent your vehicle from skidding and hydroplaning. Built-in treadwear indicators, or wear bars, which look like narrow strips of smooth rubber across the tread will appear on the tire when the tread is worn down to one sixteenth of an inch (2 millimeters).

When the tire tread wears down to the same height as these wear bars, the tire is worn out and must be replaced.

Damage

Periodically inspect the tire treads and sidewalls for damage (such as bulges in the tread or sidewalls, cracks in the tread groove and separation in the tread or sidewall). If damage is observed

or suspected have the tire inspected by a tire professional. Tires can be damaged during off-road use, so inspection after off-road use is also recommended.

Age



WARNING: Tires degrade over time depending on many factors such as weather, storage conditions, and conditions of use (load, speed, inflation pressure) the tires experience throughout their lives.



WARNING: In general, tires should be replaced after six years regardless of tread wear or even if they have not been used. However, heat caused by hot climates or frequent high-load conditions can accelerate the aging process and may require you to replace tires more frequently.



WARNING: You should replace your spare tire when you replace the road tires or after six years due to aging even if it has not been used.

Wheels and Tires

U.S. DOT Tire Identification Number

Both United States and Canada Federal regulations require tire manufacturers to place standardized information on the sidewall of all tires. This information identifies and describes the fundamental characteristics of the tire and also provides a U.S. DOT Tire Identification Number for safety standard certification and in case of a recall.

This begins with the letters DOT and indicates that the tire meets all federal standards. The next two numbers or letters are the plant code designating where it was manufactured, the next two are the tire size code and the last four numbers represent the week and year the tire was built. For example, the numbers 317 mean the 31st week of 1997. After 2000 the numbers go to four digits. For example, 2501 means the 25th week of 2001. The numbers in between are identification codes used for traceability. This information is used to contact customers if a tire defect requires a recall.

Tire Replacement Requirements

Your vehicle is equipped with tires designed to provide a safe ride and handling capability.



WARNING: Only use replacement tires and wheels that are the same size, load index, speed rating and type (such as P-metric versus LT-metric or all-season versus all-terrain) as those originally provided by Ford. The recommended tire and wheel size may be found on either the Safety Compliance Certification Label (affixed to either the door hinge pillar, door-latch post, or the door edge that meets the door-latch post, next to the driver's seating position), or the Tire Label which is located on the B-Pillar or edge of the driver's door. If this information is not found on these labels, then you should contact your authorized dealer as soon as possible. Use of any tire or wheel not recommended by Ford can affect the safety and performance of your vehicle, which could result in an increased risk of loss of vehicle control, vehicle rollover, personal injury and death.

Wheels and Tires

 **WARNING:** To reduce the risk of serious injury, when mounting replacement tires and wheels, you should not exceed the maximum pressure indicated on the sidewall of the tire to set the beads without additional precautions listed below. If the beads do not seat at the maximum pressure indicated, re-lubricate and try again.

 **WARNING:** When inflating the tire for mounting pressures up to 20 psi (1.38 bar) greater than the maximum pressure on the tire sidewall, the following precautions must be taken to protect the person mounting the tire:

 **WARNING:** 1. Make sure that you have the correct tire and wheel size.

 **WARNING:** 2. Lubricate the tire bead and wheel bead seat area again.

 **WARNING:** 3. Stand at a minimum of 12 ft (3.66 m) away from the wheel and tire assembly.

 **WARNING:** 4. Use both eye and ear protection.

 **WARNING:** For a mounting pressure more than 20 psi (1.38 bar) greater than the maximum pressure, a Ford dealer or other tire service professional should do the mounting.

 **WARNING:** Always inflate steel carcass tires with a remote air fill with the person inflating standing at a minimum of 12 ft (3.66 m) away from the wheel and tire assembly.

Important: Remember to replace the wheel valve stems when the road tires are replaced on your vehicle

It is recommended that the two front tires or two rear tires generally be replaced as a pair.

Replacing a Tire That is Greenhouse Gas Certified

The tires installed on this vehicle at the factory as original equipment are certified for Greenhouse Gas and Fuel Efficiency regulations. Replacement tires must be of equal or lower rolling resistance level (TRRL or Crr). Consult with your tire supplier(s) for appropriate replacement tires.

Wheels and Tires

Safety Practices



WARNING: If your vehicle is stuck in snow, mud or sand, do not rapidly spin the tires; spinning the tires can tear the tire and cause an explosion. A tire can explode in as little as three to five seconds.



WARNING: Do not spin the wheels at over 34 mph (55 km/h). The tires may fail and injure a passenger or bystander.

Driving habits have a great deal to do with your tire mileage and safety.

- *Observe posted speed limits
- *Avoid fast starts, stops and turns
- *Avoid potholes and objects on the road
- *Do not run over curbs or hit the tire against a curb when parking

Highway Hazards

No matter how carefully you drive there's always the possibility that you may eventually have a flat tire on the highway. Drive slowly to the closest safe area out of traffic. This may further damage the flat tire, but your safety is more important.

If you feel a sudden vibration or ride disturbance while driving, or you suspect your tire or vehicle has been damaged, immediately reduce your speed. Drive with caution until you can safely pull off the road. Stop and inspect the tires for damage. If a tire is under-inflated or damaged, deflate it, remove wheel and replace it with your spare tire and wheel. If you cannot detect a cause, have the vehicle towed to the nearest repair facility or tire dealer to have the vehicle inspected.

Tire and Wheel Alignment

A bad jolt from hitting a curb or pothole can cause the front end of your vehicle to become misaligned or cause damage to your tires. If your vehicle seems to pull to one side when you're driving, the wheels may be out of alignment. Have an authorized dealer check the wheel alignment periodically.

Wheel misalignment in the front or the rear can cause uneven and rapid treadwear of your tires and should be corrected by an authorized dealer. Front-wheel drive vehicles and those with an independent rear suspension may require alignment of all four wheels.

The tires should also be balanced periodically. An unbalanced tire and wheel assembly may result in irregular tire wear.

Wheels and Tires

Tire Rotation

Note: If your tires show uneven wear ask an authorized dealer to check for and correct any wheel misalignment, tire imbalance or mechanical problem involved before tire rotation.

Note: Your vehicle may be equipped with a dissimilar spare wheel and tire assembly. A dissimilar spare wheel and tire assembly is defined as a spare wheel and tire assembly that is different in brand, size or appearance from the road tires and wheels. If you have a dissimilar spare wheel and tire assembly it is intended for temporary use only and should not be used in a tire rotation.

Note: After having your tires rotated, inflation pressure must be checked and adjusted to the vehicle requirements.

Rotating your tires at the recommended interval (as indicated in the Scheduled Maintenance chapter) will help your tires wear more evenly, providing better tire performance and longer tire life.

Dual rear wheel drive vehicle - six tire rotation

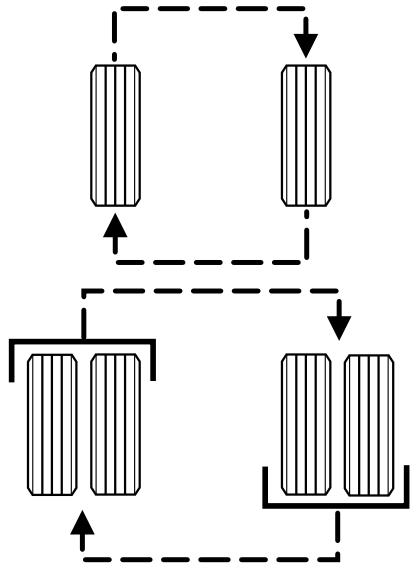

E161439

If your vehicle is equipped with dual rear wheels it is recommended that the front and rear tires (in pairs) be rotated only side to side. We do not recommend splitting up the dual rear wheels. Rotate them side to side as a set. After tire rotation, inflation pressures must be adjusted for the tires new positions in accordance with vehicle requirements.

Sometimes irregular tire wear can be corrected by rotating the tires.

Wheels and Tires

USING SNOW CHAINS



WARNING: Wheels and tires must be the same size, load index and speed rating as those originally fitted on the vehicle. Use of any other tire or wheel can affect the safety and performance of your vehicle. Additionally, the use of non-recommended tires and wheels can cause steering, suspension, axle, transfer case or power transfer unit failure. Follow the recommended tire inflation pressures found on the Safety Compliance Certification label, or the Tire Label on the B-Pillar or the edge of the driver door. Failure to follow this instruction could result in loss of vehicle control, vehicle rollover, or personal injury or death.

The tires on your vehicle have all-weather treads to provide traction in rain and snow. However, in some climates, you may need to use snow tires and cables. If you need to use cables, it is recommended that steel wheels (of the same size and specifications) be used, as cables may chip aluminum wheels.

Note: *The suspension insulation and bumpers help prevent vehicle damage. Do not remove these components from your vehicle when using snow tires and chains.*

Follow these guidelines when using snow tires and chains:

- If possible, avoid fully loading your vehicle.
- Install chains securely, verifying that the chains do not touch any wiring, brake lines or fuel lines.
- Drive cautiously. If you hear the chains rub or bang against your vehicle, stop and retighten the chains. If this does not work, remove the chains to prevent damage to your vehicle.
- Remove the snow chains when they are no longer needed. Do not use snow chains on dry roads.

Please contact your upfitter for approved snow chain types/sizes and other recommendations for snow chain use.

Wheels and Tires

TECHNICAL SPECIFICATIONS

Wheel Lug Nut Torque Specifications



WARNING: When you install a wheel, remove any corrosion, dirt or foreign materials present on the mounting surfaces of the wheel or the surface of the wheel hub, brake drum or brake disc that contacts the wheel. Make sure to secure any fasteners that attach the rotor to the hub so they do not interfere with the mounting surfaces of the wheel. Installing wheels without following these steps can cause the wheel nuts to loosen and the wheel to come off while your vehicle is in motion, resulting in loss of vehicle control, personal injury or death.

Bolt size	lb-ft (Nm) ¹
M14 x 1.5 (19.5 inch wheels)	150 (200)
M22 x 1.5 (22.5 inch wheels)	450 (610)

¹ Torque specifications are for nut and bolt threads free of dirt and rust. Use only Ford recommended replacement fasteners.

On vehicles equipped with dual rear wheels, retighten the wheel lug nuts to the specified torque at 100 miles (160 kilometers), and again at 500 miles (800 kilometers) of new vehicle operation and after any wheel disturbance (such as tire rotation, changing a flat tire, wheel removal).

On all two-piece flat wheel nuts, apply one drop of motor oil between the flat washer and the nut. Do not apply motor oil to the wheel nut threads or the wheel stud threads.



E161443

Capacities and Specifications

ENGINE SPECIFICATIONS

Engine	7.3L V8 Engine
Displacement.	445 in ³ (7,293 cm ³)
Required fuel.	Minimum 87 octane
Firing order.	1-5-4-8-6-3-7-2
Ignition system.	Coil near spark plug with spark plug wire
Spark plug gap.	0.049 in (1.25 mm) - 0.053 in (1.35 mm)
Compression ratio.	10.5:1

Drivebelt Routing

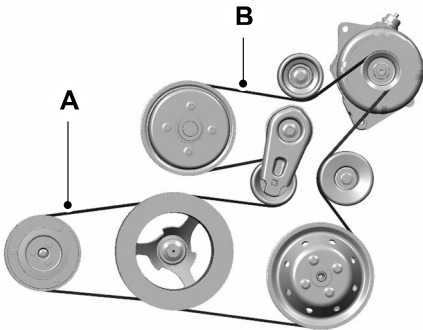

- A Drivebelt closest to the engine.
- B Drivebelt furthest from the engine.

Capacities and Specifications

MOTORCRAFT PARTS

Component	Motorcraft Part Number
Air filter element.	FA-1782-A
Battery-motorhome chassis.	BXT-65-750
Battery-commercial chassis (except UPS chassis).	BXT-65-750
Battery-commercial chassis (UPS chassis).	BH-31-XT
Engine oil filter. ¹	FL-820-S
Spark plug. ²	SP-589
Automatic transmission fluid filter (6R140).	FT-187

¹If a Motorcraft oil filter is not available, use an oil filter that aligns to SAE/USCAR – 36 Performance Specifications. Filter Type D.

²For spark plug replacement, contact your authorized dealer. Replace the spark plugs at the recommended intervals. See **Normal Scheduled Maintenance** (page 168).

We recommend Motorcraft® parts that are available at your authorized dealer or at www.fordparts.com. We engineer these parts for your vehicle to meet or exceed our specifications. Use of other parts could impact vehicle performance, emissions and durability. Your warranty could be void for any damage related to use of other parts.

Capacities and Specifications

VEHICLE IDENTIFICATION NUMBER

The Vehicle Identification Number (VIN) is on the back of the steering member at one of the following locations.

Motorhome Chassis

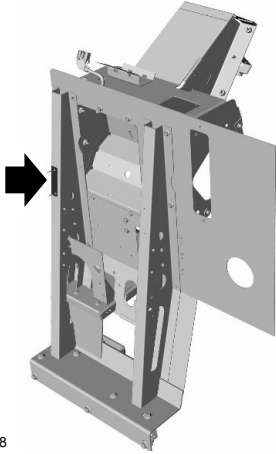

E251918

Commercial Chassis

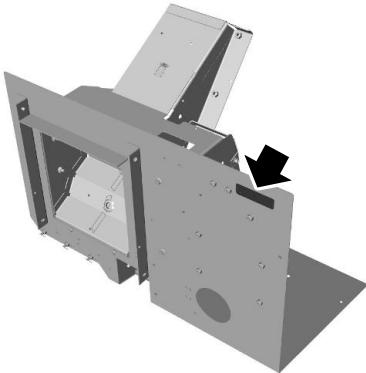

Note: The body builder includes an additional VIN tag that could be on the driver side of the dash, the A-pillar, or near the driver door.

If you ever find it necessary to communicate with us about your vehicle, always include the VIN in your communication. The VIN contains the following information:

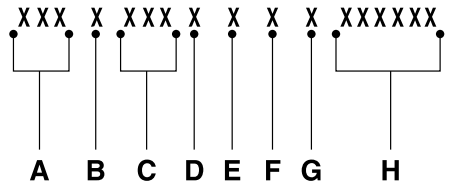

- A World manufacturer identifier.
- B Brake system, gross vehicle weight rating, restraint devices and their locations.
- C Make, vehicle line, series, body type.
- D Engine type.
- E Check digit.
- F Model year.
- G Assembly plant.
- H Production sequence number.

Capacities and Specifications

TRANSMISSION CODE DESIGNATION

The transmission code is on the Safety Compliance Certification Label. The following table shows the transmission code along with the transmission description.

MFD. BY FORD MOTOR CO.

DATE: XX/XX GVWR: XXXX KG (XXXX LB)
 FRONT GAWR: REAR GAWR:
 XXXX KG (XXXX LB) WITH XXXX KG (XXXX LB) WITH
 XXXXXXXXXXXXXXXX TIRES XXXXXXXXXXXXXXXX TIRES
 XXXXXXXX RIMS XXXXXXXX RIMS
 AT XXXX kPa/ XXX PSI COLD AT XXXX kPa/ XXX PSI COLD

THIS VEHICLE CONFORMS TO ALL APPLICABLE FEDERAL MOTOR VEHICLE SAFETY AND THEFT PREVENTION STANDARDS IN EFFECT ON THE DATE OF MANUFACTURE SHOWN ABOVE.

VIN: XXXXXXXXXXXXXXXX XXXXX
 TYPE: XXXX XXXXX



EXT PNT: XX XXXXXX RC: XY DSO: XXXX
 WB INT TR TP/PS R AXLE TR SPR XXXX
 XXX XX XXX X XX X XXXX XXXX
 XXXXXXXXXXXXXXXX XX XXXX-XXXXXX-XX



E167814

Description	Code
Six Speed Automatic Transmission (6R140)	P

Capacities and Specifications

CAPACITIES AND SPECIFICATIONS

If you do not use oil and fluid that meets the defined specification and viscosity grade, it could result in:

- Component damage not covered by the vehicle warranty.
- Longer engine cranking periods.
- Increased emission levels.
- Reduced engine performance.

- Reduced fuel economy.
- Reduced brake performance.

Air Conditioning System

 **WARNING:** The air conditioning refrigerant system contains refrigerant under high pressure. Only qualified personnel should service the air conditioning refrigerant system. Opening the air conditioning refrigerant system can cause personal injury.

Capacities

Variant	Refrigerant	Refrigerant Oil
All.	44.1 oz (1.25 kg)	8.5 fl oz (250 ml)

Materials

Name	Specification
Motorcraft® R-134a Refrigerant(U.S.) R-134a Refrigerant / Frigorigène R-134a(Canada) YN-19(U.S.) CYN-19-RB(Canada)	WSH-M17B19-A
Motorcraft® PAG Refrigerant Compressor Oil(U.S.) Motorcraft® PAG Refrigerant Compressor Oil / Huile PAG pour compresseur frigorifique Motor- craft®(Canada) YN-12-D(U.S. & Canada)	WSH-M1C231-B

Automatic Transmission

Note: Only use MERCON® LV transmission fluid for automatic transmissions that require MERCON® LV transmission fluid. The use of any other fluid could cause transmission damage.

Capacities and Specifications

Capacities

Variant	Quantity
Six-speed automatic transmission (6R140).	17.2 qt (16.3 L) ¹

¹ Approximate dry fill capacity. Actual amount could vary during fluid changes.

Materials

Name	Specification
Motorcraft® MERCON® LV Automatic Transmission Fluid(U.S.) Motorcraft® MERCON® LV Automatic Transmission Fluid / Huile pour boîte automatique MERCON® LV Motorcraft®(Canada) XT-10-QLVC(U.S.) CXT-10-LV6(Canada)	WSS-M2C938-A

Engine Coolant

Capacities

Variant	Quantity
All.	19.9 qt (18.8 L)

Materials

Name	Specification
Motorcraft® Yellow Prediluted Antifreeze/Coolant(U.S.) Motorcraft® Yellow Prediluted Antifreeze/Coolant / Antigél/liquide de refroidissement prédilué jaune Motorcraft®(Canada) VC-13DL-G(U.S.) CVC-13DL-G(Canada)	WSS-M97B57-A2

Capacities and Specifications

Engine Oil



An oil that displays this symbol conforms to current engine, emission system and fuel economy performance standards of ILSAC.

We recommend Motorcraft® motor oil for your vehicle. If Motorcraft® oil is not available, use motor oils of the recommended viscosity grade that display the API Certification Mark for gasoline engines.

Do not use supplemental engine oil additives because they are unnecessary and could lead to engine damage that your vehicle warranty does not cover.

Capacities

Variant	Including the Oil Filter
All.	8.0 qt (7.6 L)

Materials

Name	Specification
Motorcraft® SAE 5W-30 Motor Oil (U.S.) Motorcraft® SAE 5W-30 Motor Oil / Huile moteur SAE 5W-30 Motorcraft® (Canada) XO-5W30-Q1SP, XO-5W30-Q1FS (U.S.) CXO-5W30-LSP6, CXO-5W30-LFS6 (Canada)	WSS-M2C961-A1

Alternative Engine Oil for Extremely Cold Climates

To improve engine cold start performance, we recommend that you use the following alternative engine oil in extremely cold climates, where the ambient temperature reaches -22.0°F (-30°C) or below.

Materials

Name	Specification
Engine Oil - SAE 0W-30	WSS-M2C963-A1

Capacities and Specifications

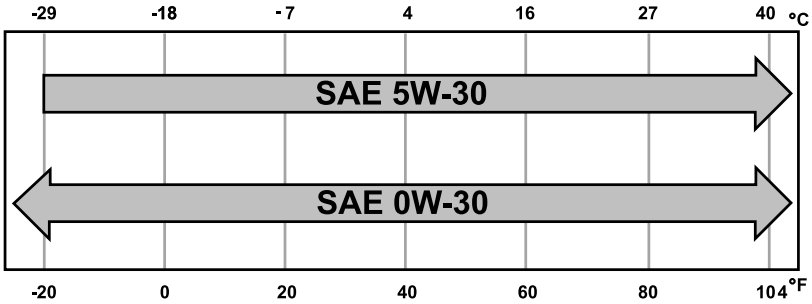

Note: If you use your vehicle regularly above the altitude of 5,000 ft (1,524 m) and under the temperature of -4.0°F (-20°C), it is recommended to use the alternative engine oil.

Fuel Tank

Capacities

Variant	Quantity
Commercial chassis.	40 gal (151 L)
Motorhome.	80 gal (303 L)

Grease

Materials

Name	Specification
Motorcraft® Premium Long-Life Grease (U.S.) Motorcraft® Premium Long-Life Grease / Graisse longue durée de qualité première Motorcraft® (Canada) XG-1-E1 (U.S. & Canada)	ESA-M1C75-B
Motorcraft® Multi-Purpose Grease Spray (U.S.) Motorcraft® Multi-Purpose Grease Spray / Graisse tout usage en aérosol Motorcraft® (Canada) XL-5-A (U.S. & Canada)	ESB-M1C93-B

Capacities and Specifications

Hydromax Brake System

Capacities

Variant	Quantity
All.	Fill as required.

Materials

Name	Specification
Motorcraft® DOT 5.1 Motor Vehicle Brake Fluid (U.S.) Motorcraft® DOT 5.1 Motor Vehicle Brake Fluid / Liquide de frein automobile DOT 5.1 Motor- craft® (Canada) PM-21 (U.S. & Canada)	WSS-M6C65-A3

Note: Motorcraft® DOT 5.1 Motor Vehicle Brake Fluid is for vehicles with Hydromax brake booster systems. We recommend using DOT 5.1 Motor Vehicle Brake Fluid or equivalent meeting WSS-M6C65-A3. This includes chassis with gross vehicle weight ratings of 19,500 lb (8,845 kg), 20,500 lb (9,299 kg), 22,000 lb (9,979 kg), 24,000 lb (10,886 kg) and 26,000 lb (11,793 kg).

Note: Use of any fluid other than the recommended fluid could cause reduced brake performance and not meet our performance standards. Keep brake fluid clean and dry. Contamination with dirt, water, petroleum products or other materials could result in brake system damage and possible failure.

Hydroboost Brake System

Capacities

Variant	Quantity
All.	Fill as required.

Materials

Name	Specification
Motorcraft® DOT 5.1 Motor Vehicle Brake Fluid (U.S.) Motorcraft® DOT 5.1 Motor Vehicle Brake Fluid / Liquide de frein automobile DOT 5.1 Motor- craft® (Canada) PM-21 (U.S. & Canada)	WSS-M6C65-A3

Capacities and Specifications

Note: Motorcraft® DOT 5.1 Motor Vehicle Brake Fluid is for vehicles with Hydroboost brake booster systems. We recommend using DOT 5.1 Motor Vehicle Brake Fluid or equivalent meeting WSS-M6C65-A3. This includes chassis with gross vehicle weight ratings of 16,000 lb (7,257 kg), 18,000 lb (8,165 kg), and 19,500 lb (8,845 kg).

Note: Use of any fluid other than the recommended fluid could cause reduced brake performance and not meet our performance standards. Keep brake fluid clean and dry. Contamination with dirt, water, petroleum products or other materials could result in brake system damage and possible failure.

Power Steering System

Materials

Name	Specification
Motorcraft® MERCON® LV Automatic Transmission Fluid(U.S.) Motorcraft® MERCON® LV Automatic Transmission Fluid / Huile pour boîte automatique MERCON® LV Motorcraft®(Canada) XT-10-QLVC(U.S.) CXT-10-LV6(Canada)	WSS-M2C938-A

Rear Axle

Capacities

Variant	Quantity
S-110/S-130.	7.0 qt (6.6 L)
S-140.	10.6 qt (10 L)

Materials

Name	Specification
Motorcraft® SAE 75W-140 Synthetic Rear Axle Lubricant(U.S.) Motorcraft® SAE 75W-140 Synthetic Rear Axle Lubricant / Lubrifiant synthétique pour pont arrière SAE 75W-140 Motorcraft®(Canada) XY-75W140-QL(U.S.) CXY-75W140-1L(Canada)	WSL-M2C192-A

Capacities and Specifications

Washer Reservoir

Capacities

Variant	Quantity
All.	Fill as required.

Materials

Name	Specification
Motorcraft® Premium Windshield Wash Concentrate with Bitterant (U.S.) Motorcraft® Premium Quality Windshield Washer Fluid -35 °C / Liquide lave-glace de haute qualité -35 °C Motorcraft® (Canada) ZC-32-B2 (U.S.) CXC-37-M (Canada)	WSS-M14P19-A

Connected Vehicle

CONNECTED VEHICLE REQUIREMENTS

Connected service and related feature functionality requires a compatible vehicle network.

Some remote features require additional service activation. Log in to your Ford account for details. Some restrictions, third party terms and message or data rates may apply.

CONNECTED VEHICLE LIMITATIONS

Evolving technology, cellular networks, or regulations could affect functionality and availability, or continued provision of some features. These changes could even stop some features from functioning.

CONNECTING THE VEHICLE TO A MOBILE NETWORK

WHAT IS THE MODEM



The modem allows access to a range of features built into your vehicle.

ENABLING AND DISABLING THE MODEM

1. Press **Settings**.

2. Press **FordPass Connect**.
3. Press **Connectivity Settings**.
4. Switch connectivity features on or off.

CONNECTING FORDPASS TO THE MODEM

1. Make sure that the modem is enabled using the vehicle settings menu.
2. Open the FordPass app on your device and log in.
3. Add your vehicle or select your vehicle if already added.
4. Select the option to activate your vehicle.
5. Make sure that the name on the screen matches the name shown in your FordPass account.
6. Confirm that FordPass account is connected to the modem.

CONNECTING THE VEHICLE TO A WI-FI NETWORK

1. Press **Settings**.
2. Press **Wi-Fi**.
3. Switch **Wi-Fi** on.
4. Press **View Available Networks**.
5. Select an available Wi-Fi network.

Note: Enter the network password to connect to a secure network.

Connected Vehicle

CONNECTED VEHICLE – TROUBLESHOOTING

Wi-Fi Network

Symptom	Possible Cause and Resolution
I cannot connect to a Wi-Fi network.	<ul style="list-style-type: none">– Password error.<ul style="list-style-type: none">• Enter the correct network password.– Weak network signal.<ul style="list-style-type: none">• Move your vehicle closer to the Wi-Fi hotspot or to a place where the network signal is not obstructed.– Multiple access points in range with the same SSID.<ul style="list-style-type: none">• Use a unique name for your SSID. Do not use the default name unless it contains a unique identifier, for example as part of the MAC address.
The Wi-Fi connection disconnects after successful connection.	<ul style="list-style-type: none">– Weak network signal.<ul style="list-style-type: none">• Move your vehicle closer to the Wi-Fi hotspot or to a place where the network signal is not obstructed.
I am close to a Wi-Fi hotspot but the network signal strength is weak.	<ul style="list-style-type: none">– Obstructed network signal.<ul style="list-style-type: none">• If your vehicle has a heated windshield, position your vehicle so that the windshield is not facing the Wi-Fi hotspot.• If your vehicle has metallic tinting on the windows but not on the windshield, position your vehicle so that the windshield is facing the Wi-Fi hotspot or open the windows that are facing the hotspot.• If your vehicle has metallic tinting on the windows and the windshield, open the windows that are facing the hotspot.• If your vehicle is in a garage and you have the garage door closed, open the garage door.
I cannot see a network in the list of available networks that I expect to see.	<ul style="list-style-type: none">– Hidden network.<ul style="list-style-type: none">• Make the network visible and try again.

Connected Vehicle

Symptom	Possible Cause and Resolution
I cannot see the Wi-Fi hotspot name when I search for Wi-Fi networks on my cell phone or other device.	<ul style="list-style-type: none"> – System limitation. <ul style="list-style-type: none"> • Make sure Wi-Fi hotspot visibility is on. • The system does not provide a Wi-Fi hotspot at this time.
Software downloads take too long.	<ul style="list-style-type: none"> – Weak network signal <ul style="list-style-type: none"> • Move your vehicle closer to the Wi-Fi hotspot or to a place where the network signal is not obstructed. – Wi-Fi hotspot in high demand or has a slow Internet connection. <ul style="list-style-type: none"> • Use a more reliable Wi-Fi hotspot.
The system seems to connect to a Wi-Fi network and the signal strength is excellent but the software does not update.	<ul style="list-style-type: none"> – No software update available. – Wi-Fi network requires a subscription or acceptance of terms and conditions. <ul style="list-style-type: none"> • Test the connection using another device. If the network requires a subscription or acceptance of terms and conditions, contact the network service provider.

Mobile Network

Symptom	Possible Cause and Resolution
I cannot confirm the connection of FordPass account to the modem.	<ul style="list-style-type: none"> – Modem is not enabled. <ul style="list-style-type: none"> • Switch connectivity features on. – Weak network signal. <ul style="list-style-type: none"> • Move your vehicle closer to a place where the network signal is not obstructed.

Ford Protect

PROTECT YOURSELF FROM THE RISING COST OF VEHICLE REPAIRS WITH A FORD PROTECT EXTENDED SERVICE PLAN.

Ford Protect Extended Service Plans (U.S. Only)

Ford Protect extended service plan means peace of mind. It is the extended service plan backed by Ford Motor Company, and provides more protection beyond the New Vehicle Limited Warranty coverage. When you visit your Ford Dealer, Insist on Ford Protect extended service plans!

Ford Protect Can Quickly Pay for Itself

One trip to the Service Center could easily exceed the price of your Ford Protect extended service plan. With Ford Protect extended service plan you minimize your risk for unexpected repair bills and rising repair costs.

Up to 1,000+ Covered Vehicle Components

There are four mechanical Ford Protect extended service plans with different levels of coverage. Ask your authorized dealer for details.

1. PremiumCARE - Our most comprehensive coverage. With over 1,000 covered components, this plan is so complete it is probably easier to list what is not covered.
2. ExtraCARE - Covers 113 components, and includes many high-tech items.
3. BaseCARE - Covers 84 components.
4. PowertrainCARE - Covers 29 critical components.

Ford Protect extended service plans are honored by all authorized Ford dealers in the U.S., Canada and Mexico.

That means you get:

- Reliable, quality service at any Ford or Lincoln dealership.
- Repairs performed by factory trained technicians, using genuine parts.

Rental Car Reimbursement

1st day Rental Benefit

If you bring your car into your dealer for service, we'll give you a loaner to use for the day.

Extended Rental Benefits

If your vehicle is kept overnight for covered repairs, you are eligible for rental car coverage, including warranty repairs, and Field Service Actions.

Roadside Assistance

Exclusive 24/7 roadside assistance, including:

- Towing, flat-tire change and battery jump starts.
- Out of fuel and lock-out assistance.
- Travel expense reimbursement for lodging, meals and rental car.
- Assistance for taxi, shuttle, rental car coverage or other transportation.

Transferable Coverage

If you sell your vehicle before your Ford Protect extended service plan coverage expires, you can transfer any remaining coverage to the new owner. Which should give you and your potential buyer a little more peace of mind.

Ford Protect

Less Cost to Properly Maintain Your Vehicle

Ford Protect extended service plan also offers a Premium Maintenance Plan that covers all scheduled maintenance, and selected wear items. The coverage is prepaid, so you never have to worry about the cost of your vehicle's maintenance.

Covered maintenance includes:

- Windshield wiper blades.
- Spark plugs.
- The clutch disc (if equipped).
- Brake pads and linings.
- Shock absorbers.
- Struts.
- Engine belts.
- Engine coolant hoses, clamps and O-rings.
- Diesel exhaust fluid replenishment (if equipped).
- Cabin air filter replacement every 20,000 mi (32,000 km) (electric vehicles only).

Interest Free Finance Options

Just a 5% down payment will provide you with an affordable, no interest, no fee payment program allowing you all the security and benefits Ford Protect extended service plan has to offer while paying over time. You are pre-approved with no credit check or hassles. To learn more, call our Ford Protect extended service plan specialists at 800-367-3377.

Ford Protect Extended Service Plan
P.O. Box 321067
Detroit, MI 48232

Ford Protect Extended Service Plan (CANADA ONLY)

You can get more protection for your vehicle by purchasing a Ford Protect extended service plan. Ford Protect extended service plan is the only service contract backed by Ford Motor Company of Canada, Limited. Depending on the plan you purchase, Ford Protect extended service plan provides benefits such as:

- Rental reimbursement.
- Coverage for certain maintenance and wear items.
- Protection against repair costs after your New Vehicle Limited Warranty Coverage expires.
- Roadside Assistance benefits.

There are several Ford Protect extended service plans available in various time, distance and deductible combinations. Each plan is tailored to fit your own driving needs, including reimbursement for towing and rental. When you purchase Ford Protect extended service plan, you receive added peace-of-mind protection throughout Canada, the United States and Mexico, provided by a network of participating authorized Ford Motor Company dealers.

Note: *Repairs performed outside of Canada and the United States are not eligible for Ford Protect extended service plan coverage.*

This information is subject to change. For more information; visit your local Ford of Canada dealer or www.ford.ca to find the Ford Protect extended service plan that is right for you.

Scheduled Maintenance

GENERAL MAINTENANCE INFORMATION

Why Maintain Your Vehicle?

Carefully following the maintenance schedule helps protect against major repair expenses resulting from neglect or inadequate maintenance and may help to increase the value of your vehicle when you sell or trade it. Keep all receipts for completed maintenance with your vehicle.

We have established regular maintenance intervals for your vehicle based upon rigorous testing. It is important that you have your vehicle serviced at the proper times. These intervals serve two purposes; one is to maintain the reliability of your vehicle and the second is to keep your cost of owning your vehicle down.

It is your responsibility to have all scheduled maintenance performed and to make sure that the materials used meet the specifications identified in this owner's manual. See **Capacities and Specifications** (page 149).

Failure to perform scheduled maintenance invalidates warranty coverage on parts affected by the lack of maintenance.

Why Maintain Your Vehicle at Your Dealership?

Factory-trained Technicians

Service technicians participate in extensive factory-sponsored certification training to help them become experts on the operation of your vehicle. Ask your dealership about the training and certification their technicians have received.

Genuine Ford and Motorcraft Replacement Parts

Dealerships stock Ford, Motorcraft and Ford-authorized branded re-manufactured replacement parts. These parts meet or exceed our specifications. Parts installed at your dealership carry a nationwide 24-month or unlimited mile (kilometer) parts and labor limited warranty.

If you do not use Ford authorized parts they may not meet our specifications and depending on the part, it could affect emissions compliance.

Convenience

Many dealerships have extended evening and Saturday hours to make your service visit more convenient and they offer one stop shopping. They can perform any services that are required on your vehicle, from general maintenance to collision repairs.

Note: *Not all dealers have extended hours or body shops. Please contact your dealer for details.*

Protecting Your Investment

Maintenance is an investment that pays dividends in the form of improved reliability, durability and resale value. To maintain the proper performance of your vehicle and its emission control systems, make sure you have scheduled maintenance performed at the designated intervals.

Your vehicle is very sophisticated and built with multiple, complex, performance systems. Every manufacturer develops these systems using different specifications and performance features. That is why it is important to rely upon your dealership to properly diagnose and repair your vehicle.

Scheduled Maintenance

Ford Motor Company has recommended maintenance intervals for various parts and component systems based upon engineering testing. Ford Motor Company relies upon this testing to determine the most appropriate mileage for replacement of oils and fluids to protect your vehicle at the lowest overall cost to you and recommends against maintenance schedules that deviate from the scheduled maintenance information.

Your vehicle can be driven in such a way that dilutes and increases the level of oil by short trips that do not allow the engine to get to operating temperature, extended idling, and low speed driving for long periods of time.

We strongly recommend the use of only genuine Ford, Motorcraft or Ford-authorized re-manufactured replacement parts engineered for your vehicle.

Additives and Chemicals

This owner's manual and the Ford Workshop Manual list the recommended additives and chemicals for your vehicle. We do not recommend using chemicals or additives not approved by us as part of your vehicle's normal maintenance. Please consult your warranty information.

Oils, Fluids and Flushing

In many cases, fluid discoloration is a normal operating characteristic and, by itself, does not necessarily indicate a concern or that the fluid needs to be changed. However, a qualified expert, such as the factory-trained technicians at your dealership, should inspect discolored fluids that also show signs of overheating or foreign material contamination immediately.

Make sure to change your vehicle's oils and fluids at the specified intervals or in conjunction with a repair. Flushing is a viable way to change fluid for many vehicle sub-systems during scheduled maintenance. It is critical that systems are flushed only with new fluid that is the same as that required to fill and operate the system or using a Ford-approved flushing chemical.

Owner Checks and Services

Make sure you perform the following basic maintenance checks and inspections every month or at six-month intervals.

Check every month
Engine oil level.
Function of all interior and exterior lights.
Tires (including spare) for wear and proper pressure.
Windshield washer fluid level.

Scheduled Maintenance

Check every six months
Battery connections. Clean if necessary.
Body and door drain holes for obstructions. Clean if necessary.
Cooling system fluid level and coolant strength.
Door weatherstrips for wear. Lubricate if necessary.
Hinges, latches and outside locks for proper operation. Lubricate if necessary.
Parking brake for proper operation.
Seatbelts and seat latches for wear and function.
Safety warning lamps (brake, ABS, airbag and seatbelt) for operation.
Washer spray and wiper operation. Clean or replace blades as necessary.

Multi-point Inspection

In order to keep your vehicle running right, it is important to have the systems on your vehicle checked regularly. This can help identify potential issues and prevent major problems. We recommend having the following multi-point inspection performed at every scheduled maintenance interval to help make sure your vehicle keeps running great.

Multi-point inspection	
Accessory drive belt(s)	Horn operation
Battery performance	Radiator, cooler, heater and A/C hoses
Engine air filter	Suspension component for leaks or damage
Exhaust system	Steering and linkage
Exterior lamps and hazard warning system operation	Tires (including spare) for wear and proper pressure**

Scheduled Maintenance

Multi-point inspection	
Fluid levels*; fill if necessary	Windshield for cracks, chips or pits
For oil and fluid leaks	Washer spray and wiper operation

* Brake, coolant recovery reservoir, automatic transmission, power steering and window washer.

**If your vehicle is equipped with a temporary mobility kit, check the tire sealant expiration Use By date on the canister. Replace as needed.

Be sure to ask your dealership service advisor or technician about the multi-point vehicle inspection. It is a comprehensive way to perform a thorough inspection of your vehicle. Your checklist gives you immediate feedback on the overall condition of your vehicle.

NORMAL SCHEDULED MAINTENANCE

Note: *Do not exceed the mileage or time intervals.*

Every 10,000 miles (16000 km), 12 months or 700 engine hours - whichever comes first.
Change the engine oil and filter.
Rotate the tires, inspect tire wear and measure the tread depth. ¹
Inspect the wheels and related components for abnormal noise, wear, looseness or drag.
Perform a multi-point inspection.
Inspect the automatic transmission fluid level. Consult dealer for requirements.
Inspect the brake pads, shoes, rotors, drums, brake linings, hoses and the parking brake.
Inspect the engine coolant level/strength and hoses.
Inspect the exhaust system and heat shields.
Inspect the steering linkage, ball joints, suspension, tie-rod ends, drive shaft and U-joints. Lubricate, if your vehicle has grease fittings.

¹Vehicles with dual rear wheels should rotate the front wheels when specified; rear wheels only if you notice unusual wear.

Scheduled Maintenance

Brake Fluid Maintenance¹	
Every 3 Years	Change the brake fluid. ²

¹ Perform this maintenance item every 3 years. Do not exceed the designated time for the interval.

² Brake fluid servicing requires special equipment available at your authorized dealer.

Other maintenance items	
Every 30,000 mi (48,000 km)	Replace the engine air filter.
Every 60,000 mi (96,000 km)	Replace the front wheel bearing grease and grease seal if you use non-sealed bearings.
Every 100,000 mi (160,000 km)	Replace the spark plugs.
	Replace the rear axle fluid.
	Inspect the accessory drive belt(s). ¹
Every 150,000 mi (240,000 km)	Replace the accessory drive belt(s) if not replaced within the last 100,000 mi (160,000 km).
	Replace the front wheel bearings and seals if you use non-sealed bearings.
	Change the automatic transmission fluid and filter. Consult dealer for requirements.
Every 200,000 mi (320,000 km)	Change the engine coolant. ²

¹ If not replaced, inspect every 15,000 mi (24,000 km).

² Initial replacement at 10 years or 200,000 mi (320,000 km), then every five years or 100,000 mi (160,000 km).

Scheduled Maintenance

SPECIAL OPERATING CONDITIONS SCHEDULED MAINTENANCE

If you operate your vehicle **primarily** in any of the following conditions, you need to

perform extra maintenance as indicated. If you operate your vehicle **occasionally** under any of these conditions, it is not necessary to perform the extra maintenance. For specific recommendations, see your dealership service advisor or technician.

Towing a trailer or using a car-top carrier	
Inspect frequently, service as required	Inspect U-joints.
	See axle maintenance items under Exceptions .
Every 5000 miles (8000 km)	Inspect the wheels and related components for abnormal noise, wear, looseness or drag.
	Rotate tires*, inspect tires for wear and measure tread depth.
Every 5000 miles (8000 km) or six months	Change engine oil and filter.
	Inspect U-joints.
Every 30000 miles (48000 km)	Replace front wheel bearing grease and grease seals if non-sealed bearings are used.
Every 60000 miles (96000 km)	Replace spark plugs.

*Vehicles equipped with dual rear wheels should rotate the front wheels when specified; rear wheels only if unusual wear is noted.

Extensive Idling or Low-speed Driving for Long Distances, as in Heavy Commercial Use (Such as Delivery, Taxi, Patrol Car or Livery) Short Trips that do not allow the engine to get to operating temperature causing fuel dilution and an increase of the engine oil level	
Every 5000 miles (8000 km)	Inspect brake system.
	Inspect wheels and related components for abnormal noise, wear, looseness or drag.
	Rotate tires*, inspect tires for wear and measure tread depth.
Every 5000 miles (8000 km) or six months	Inspect U-joints.

Scheduled Maintenance

Extensive Idling or Low-speed Driving for Long Distances, as in Heavy Commercial Use (Such as Delivery, Taxi, Patrol Car or Livery) Short Trips that do not allow the engine to get to operating temperature causing fuel dilution and an increase of the engine oil level	
Every 5000 miles (8000 km) or six months or 200 engine hours	Change engine oil and filter.
Every 30000 miles (48000 km)	Replace front wheel bearing grease and grease seals if non-sealed bearings are used.
Every 60000 miles (96000 km)	Replace spark plugs.

*Vehicles equipped with dual rear wheels should rotate the front wheels when specified; rear wheels only if unusual wear is noted.

Operating in dusty or sandy conditions (such as unpaved or dusty roads)	
Inspect frequently, service as required	Replace engine air filter.
	Replace cabin air filter, if equipped.
Every 5000 miles (8000 km)	Inspect the wheels and related components for abnormal noise, wear, looseness or drag.
	Rotate tires*, inspect tires for wear and measure tread depth.
Every 5000 miles (8000 km) or six months	Change engine oil and filter.
	Inspect U-joints.
Every 30000 miles (48000 km)	Replace front wheel bearing grease and grease seals if non-sealed bearings are used.
Every 50000 miles (80000 km)	Change rear axle fluid.

*Vehicles equipped with dual rear wheels should rotate the front wheels when specified; rear wheels only if unusual wear is noted.

Exceptions

There are several exceptions to the Normal Schedule:

Scheduled Maintenance

Rear axle fluid change or level check not required unless leak is suspected or the assembly has been submerged in water. During long periods of trailer towing with outside temperatures above 70°F (21°C) and at wide-open throttle for long periods above 45 mph (72 km/h), change rear axle fluid every 24,000 mi (38,000 km) or three months, whichever comes first.

California fuel filter replacement: If you register your vehicle in California, the California Air Resources Board has determined that the failure to perform this maintenance item does not nullify the emission warranty or limit recall liability before the completion of your vehicle's useful life. Ford Motor Company, however, urges you to have all recommended maintenance services performed at the specified intervals and to record all vehicle service.

Hot climate oil change intervals: Vehicles operating in the Middle East, North Africa, Sub-Saharan Africa or locations with similar climates using an American Petroleum Institute (API) Certified for Gasoline Engines (Certification mark) oil of SM or SN quality, the normal oil change interval is 5000 miles (8000 kilometers).

If the available API SM or SN oils are not available, then the oil change interval is 3000 miles (4800 kilometers).

Engine air filter and cabin air filter replacement: The life of the engine air filter and cabin air filter is dependent on exposure to dusty and dirty conditions. Vehicles operated in these conditions require frequent inspection and replacement of the engine air filter and cabin air filter.

Customer Information

RADIO FREQUENCY CERTIFICATION LABELS

CRUISE CONTROL MODULE

Device	Supplier	Type Designation
Mid Range Radar (MRR)	Delphi/Aptiv	L2C0065TR

Argentina



European Union EU

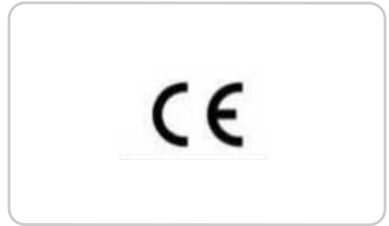

Brazil



Ghana

NCA PRODUCT IDENTIFIER: OR2-9H-7E1-x4D

Djibouti

AGREE PAR LE MCPT (REPUBLIQUE DE DJIBOUTI)

Numéro d'agrément : 594/dpt/2017

Date d'agrément : 09/04/2017

Customer Information

Indonesia

SERTIFIKAT NOMOR : 53104/SDPPI/2017
PLG ID: 4927



HIDF16000009

Mauritania

AGREE PAR L'ANE MAURITANIE

Numéro d'agrément: 0409/ARE/2017

Date d'agrément: 12/04/2017

Israel

1. מספר אישור התאמה מסוג משרד התקשורת: 51-63483
2. תל אישור לבצע פעולות בכשיר שיש בהן כדי לשנות את תכונותיו האלחוטיות של המכשיר, ובכלל זה שינויי תוכנה, החלפת אנטנה מקורית או חוספת אפשרות לחיבור לאנטנה חיצונית, בלא קבלת אישור משרד התקשורת, בשל החשש להפרעות אלחוטיות.

Moldova



Jamaica

This product has been Type Approved
by Jamaica: SMA - L2C0065TR.

Morocco

Malaysia



AGREE PAR L'ANRT MAROC

Numéro d'agrément: MR 13639 ARNT 2017

Date d'agrément: 28/03/2017

Customer Information

Pakistan



Singapore

Complies with IMDA Standards
DA105753

Paraguay



South Africa



Serbia



South Korea



R-CMM-DLH-L2C0065TR

Customer Information

Syria

SyTRA
REGISTERED No:
FR00085-17

United Arab Emirates

TRA
REGISTERED NO. ER54071/17
DEALER NO.: DA37380/15

Taiwan, China

 CCAI17LP7500T1

United Kingdom

**UK
CA**

Ukraine



United States and Canada



WARNING: Changes or modifications not expressly approved by the party responsible for compliance could void the user's authority to operate the equipment. The term "IC:" before the radio certification number only signifies that Industry Canada technical specifications were met.

FCC ID: L2C0065TR
IC: 3432A-0065TR

Customer Information

This device complies with Part 15 of the FCC Rules and with Innovation, Science and Economic Development Canada's licence-exempt RSS(s). Operation is subject to the following two conditions:

1. This device may not cause harmful interference, and
2. This device must accept any interference received, including interference that may cause undesired operation.

Zambia



WARRANTY INFORMATION

The following warranties may apply to your vehicle:

- New vehicle limited warranties.
- Emissions warranties, if applicable. (Note: Fully-electric vehicles are not eligible for emissions warranties.)
- Other warranties, if applicable.

Detailed warranty information specific to your vehicle can be found in the Warranty Guide at www.owner.ford.com.

The following California Warranty Statement, required by California regulations, applies to vehicles certified to California emissions standards and registered in a state that requires California emissions warranty. If applicable, additional California Emissions Warranties can be found in the Warranty Guide at www.owner.ford.com.

CALIFORNIA EMISSION CONTROL WARRANTY STATEMENT

YOUR WARRANTY RIGHTS AND OBLIGATIONS

The California Air Resources Board and Ford Motor Company are pleased to explain the emission control system warranty on your (year) vehicle. In California, new motor vehicles must be designated, built and equipped to meet the State's stringent anti-smog standards. Ford Motor Company must warrant the emission control system on your vehicle for the periods of time listed below provided there has been no abuse, neglect or improper maintenance of your vehicle.

Your emission control system may include parts such as the carburetor or fuel-injection system, the ignition system, catalytic converter and engine computer. Also included may be hoses, belts, connectors and other emission-related assemblies. Where a warrantable condition exists, Ford Motor Company will repair your vehicle at no cost to you including diagnosis, parts and labor.

MANUFACTURER'S WARRANTY COVERAGE:

(For 1990 and subsequent model passenger cars, light-duty trucks, and medium-duty vehicles.)

- For 3 years or 50,000 miles (whichever occurs first);

Customer Information

1) If your vehicle fails a Smog Check inspection, all necessary repairs and adjustments will be made by Ford Motor Company to ensure that your emission control system **PERFORMANCE WARRANTY**.

2) If any emission-related part on your vehicle is defective, the part will be repaired or replaced by Ford Motor Company. This is your short-term emission control system **DEFECTS WARRANTY**.

- For 7 years or 70,000 miles (whichever occurs first);

1) If an emission-related part listed in this warranty booklet specially noted with coverage for 7 years or 70,000 miles is defective, the part will be repaired or replaced by Ford Motor Company. This is your long-term emission control system **DEFECTS WARRANTY**.

OWNER'S WARRANTY RESPONSIBILITIES:

- As the vehicle owner, you are responsible for the performance of the required maintenance listed in your owner's manual. Ford Motor Company recommends that you retain all receipts covering maintenance on your vehicle, but Ford Motor Company cannot deny warranty solely for the lack of receipts or for your failure to ensure the performance of all scheduled maintenance.

- You are responsible for presenting your vehicle to a Ford or Lincoln dealer as soon as a problem exists. The warranty repairs should be completed in a reasonable amount of time, not to exceed 30 days.

- As the vehicle owner, you should also be aware that Ford Motor Company may deny you warranty coverage if your vehicle or a part has failed due to abuse, neglect, improper maintenance or unapproved modifications.

If you have any questions regarding your warranty rights and responsibilities, you should contact Ford Customer Service at 1-800-392-3673 or the California Air Resource Board at 9528 Telstar Avenue, El Monte, CA 91731.

New Vehicle Limited Warranty

Your vehicle comes with a New Vehicle Limited Warranty. The express warranties of the New Vehicle Limited Warranty are in substitution for and exclude all other liabilities of any kind whether arising under statute, in tort, by implication of law or otherwise including, to the full extent as may be allowed by law, liability for any other representations respecting the vehicle, statutory warranties or implied warranties or conditions as to its merchantability or fitness.

Download a free electronic copy or order one free printed copy of the most up-to-date Warranty Guide by visiting the Owner Manuals section of owner.ford.com (United States).

For Canada, visit ford.ca/warranty.

For Limo/Livery/Hearse vehicles: View and download your Warranty Guide by visiting the Warranty Information section of the Fleet website, fleet.ford.com/limo (United States only).

Appendices

ELECTROMAGNETIC COMPATIBILITY



WARNING: Do not place objects or mount equipment on or near the airbag cover, on the side of the front or rear seatbacks, or in areas that may come into contact with a deploying airbag. Failure to follow these instructions may increase the risk of personal injury in the event of a crash.



WARNING: Keep antenna and power cables at least 4 in (10 cm) from any electronic modules and airbags.

Note: We test and certify your vehicle to meet electromagnetic compatibility legislation. It is your responsibility to make sure that any equipment an authorized dealer installs on your vehicle complies with applicable local legislation and other requirements. Installation of some aftermarket electronic devices could degrade the performance of vehicle functions, which use radio frequency signals such as broadcast radio receiver, tire pressure monitoring system, push button start, **Bluetooth®** connectivity or satellite navigation.

Note: Any radio frequency transmitter equipment in your vehicle, such as, cellular telephones and amateur radio transmitters, must keep to the parameters in the following illustrations and table. We do not provide any other special provisions or conditions for installations or use.

Car

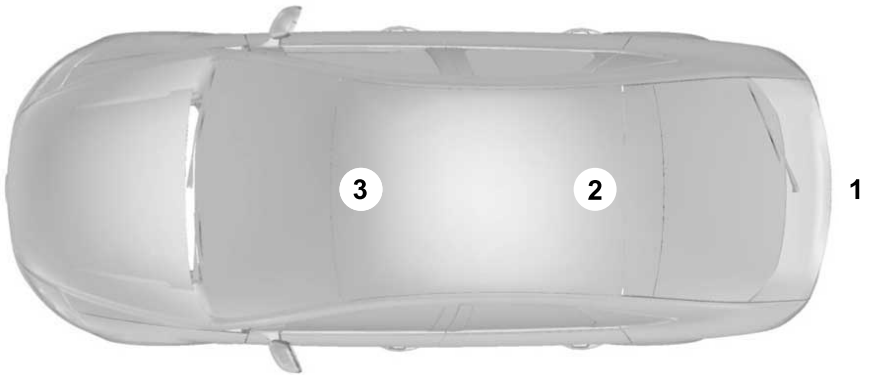

Appendices

Van



Truck

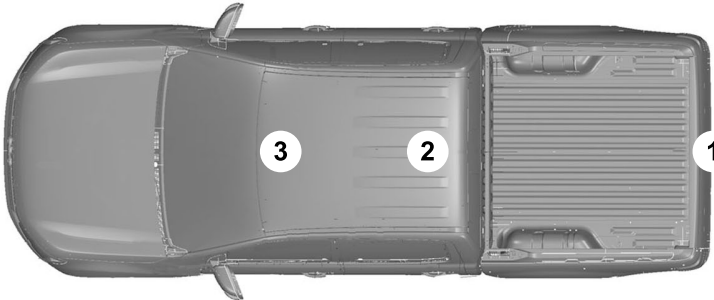

Appendices

Frequency Band MHz	Maximum Output Power Watt (Peak RMS)	Antenna Positions
1-30	50	1
50-54	50	2, 3
68-88	50	2, 3
142-176	50	2, 3
380-512	50	2, 3
806-870	10	2, 3

Index

A

About This Manual.....	5
ABS	
See: Brakes.....	55
ABS driving hints	
See: Hints on Driving With Anti-Lock Brakes.....	56
Accessories	
See: Replacement Parts Recommendation.....	8
ACC	
See: Using Adaptive Cruise Control.....	62
Adjusting the Steering Wheel.....	16
Air Filter	
See: Changing the Engine Air Filter.....	114
Appendices.....	179
Audible Warnings and Indicators.....	29
Autolamps.....	19
Automatic High Beam Control.....	22
Automatic High Beam Control Indicators.....	22
Automatic Transmission.....	51
Automatic Transmission Fluid Check.....	119

B

Battery	
See: Changing the 12V Battery.....	124
Brake Fluid Check.....	121
Brakes.....	55
General Information.....	55
Breaking-In.....	89

C

Canceling the Set Speed.....	62
Capacities and Specifications.....	153
Car Wash	
See: Cleaning the Exterior.....	127
Catalytic Converter.....	48
Changing a Fuse.....	108
Changing the 12V Battery.....	124
Changing the Engine Air Filter.....	114
Cleaning Products.....	126
Cleaning the Engine.....	128
Cleaning the Exterior.....	127

Cleaning the Wheels.....	128
Connected Vehicle.....	160
Connecting the Vehicle to a Mobile Network.....	160
Connected Vehicle Data.....	13
Connected Vehicle Limitations.....	160
Connected Vehicle Requirements.....	160
Connected Vehicle – Troubleshooting.....	161
Connecting the Vehicle to a Mobile Network.....	160
Connecting FordPass to the Modem.....	160
Enabling and Disabling the Modem.....	160
What Is the Modem.....	160
Connecting the Vehicle to a Wi-Fi Network.....	160
Coolant Check	
See: Engine Coolant Check.....	115
Crash and Breakdown Information.....	93
Cruise Control.....	61
Cruise Control Indicators.....	62
Cruise Control – Vehicles With: Adaptive Cruise Control.....	16
Cruise Control – Vehicles With: Cruise Control.....	16
Customer Assistance.....	95
Customer Information.....	173
Radio Frequency Certification Labels.....	173

D

Data Privacy.....	11
Daytime Running Lamps - Vehicles With: Configurable Daytime Running Lamps.....	20
Daytime Running Lamps - Vehicles With: Daytime Running Lamps (DRL).....	20
Direction Indicators.....	21
Driver Alert.....	69
Driving Aids.....	69
Driving Hints.....	88
Driving Through Water.....	89
DRL	
See: Daytime Running Lamps - Vehicles With: Configurable Daytime Running Lamps.....	20
See: Daytime Running Lamps - Vehicles With: Daytime Running Lamps (DRL).....	20

Index

E

Economical Driving.....	88
Electromagnetic Compatibility.....	179
Emergency Call System Data.....	14
Emission Law.....	47
Engine Block Heater.....	40
Engine Coolant Check.....	115
Engine Emission Control.....	47
Engine Oil Check.....	113
Engine Oil Dipstick.....	113
Engine Specifications.....	149
Environment.....	15
Essential Towing Checks.....	85
Event Data.....	12
Export Unique Options.....	10

F

Ford Credit.....	8
Ford Protect.....	163
Fuel and Refueling.....	42
Fuel Consumption.....	45
Fuel Filter.....	125
Fuel Quality.....	42
Fuses.....	101
Fuse Specification Chart.....	101

G

Gauges.....	24
Gearbox	
See: Transmission.....	51
General Maintenance Information.....	165
Getting Assistance Outside the U.S. and Canada.....	98
Getting the Services You Need.....	95

H

Handbrake	
See: Parking Brake.....	56
Hazard Flashers.....	90
Hill Start Assist.....	57
Hints on Driving With Anti-Lock Brakes.....	56
Horn.....	17

I

Ignition Switch.....	38
In California (U.S. Only).....	96
Information Display Control.....	17
Information Displays.....	30
General Information.....	30
Information Messages.....	34
Instrument Cluster.....	24
Instrument Lighting Dimmer.....	20
Introduction.....	5

J

Jump Starting the Vehicle.....	90
--------------------------------	----

L

Lane Keeping System.....	70
Lighting Control.....	19
Lighting.....	19
Load Carrying.....	78
Load Limit.....	78

M

Maintenance.....	110
General Information.....	110
Message Center	
See: Information Displays.....	30
Mobile Communications	
Equipment.....	10
Motorcraft Parts.....	150

N

Normal Scheduled Maintenance.....	168
-----------------------------------	-----

O

Oil Change Indicator Reset.....	114
Oil Check	
See: Engine Oil Check.....	113
Ordering Additional Owner's Literature.....	99
Overriding Automatic High Beam Control.....	23

Index

P

Parking Brake.....	56
Perchlorate.....	8
Power Steering Fluid Check.....	122
Pre-Collision Assist.....	73
Protecting the Environment.....	15

R

Radio Frequency Certification	
Labels.....	173
Cruise Control Module.....	173
Recommended Towing Weights.....	84
Reduced Engine Performance.....	88
Refueling.....	44
Replacement Parts	
Recommendation.....	8
Reporting Safety Defects (Canada	
Only).....	100
Reporting Safety Defects (U.S.	
Only).....	99
Resuming the Set Speed.....	62
Roadside Assistance.....	93
Roadside Emergencies.....	90
Running-In	
See: Breaking-In.....	89
Running Out of Fuel.....	43

S

Safety Precautions.....	42
Scheduled Maintenance.....	165
Service Data.....	12
Settings Data.....	13
Setting the Cruise Control Speed.....	61
Snow Chains	
See: Using Snow Chains.....	147
Special Notices.....	9
Special Operating Conditions Scheduled	
Maintenance.....	170
Speed Control	
See: Cruise Control.....	61
Stability Control.....	59
Principle of Operation.....	59
Starter Switch	
See: Ignition Switch.....	38
Starting a Gasoline Engine.....	39

Starting and Stopping the Engine.....	38
General Information.....	38
Steering.....	73
Steering Wheel.....	16
Switching Automatic High Beam Control	
On and Off.....	22
Switching Cruise Control On and	
Off.....	61
Symbols Glossary.....	5

T

Technical Specifications	
See: Capacities and Specifications.....	149
The Better Business Bureau (BBB) Auto	
Line Program (U.S. Only).....	97
Tire Care.....	131
Tires	
See: Wheels and Tires.....	131
Towing a Trailer.....	83
Towing the Vehicle on Four Wheels.....	87
Towing.....	83
Traction Control.....	58
Principle of Operation.....	58
Transmission Code Designation.....	152
Transmission.....	51
Transporting the Vehicle.....	92

U

Under Hood Overview - Commercial	
Chassis.....	111
Under Hood Overview - Motorhome	
Chassis.....	112
Using Adaptive Cruise Control.....	62
Using Snow Chains.....	147
Using Traction Control.....	58

V

Vehicle Care.....	126
General Information.....	126
Vehicle Identification Number.....	151
Vehicle Storage.....	129
VIN	
See: Vehicle Identification Number.....	151

Index

W

Warning Lamps and Indicators.....	27
Warranty Information.....	177
Washers	
See: Cleaning the Exterior.....	127
See: Wipers and Washers.....	18
What Is Automatic High Beam Control.....	22
What Is Cruise Control.....	61
Wheels and Tires.....	131
Technical Specifications.....	148
Wi Fi	
See: Connecting the Vehicle to a Wi-Fi Network.....	160
Windshield Washers.....	18
Windshield Wipers.....	18
Wipers and Washers.....	18