

FORD **SUPER DUTY** Owner's Manual

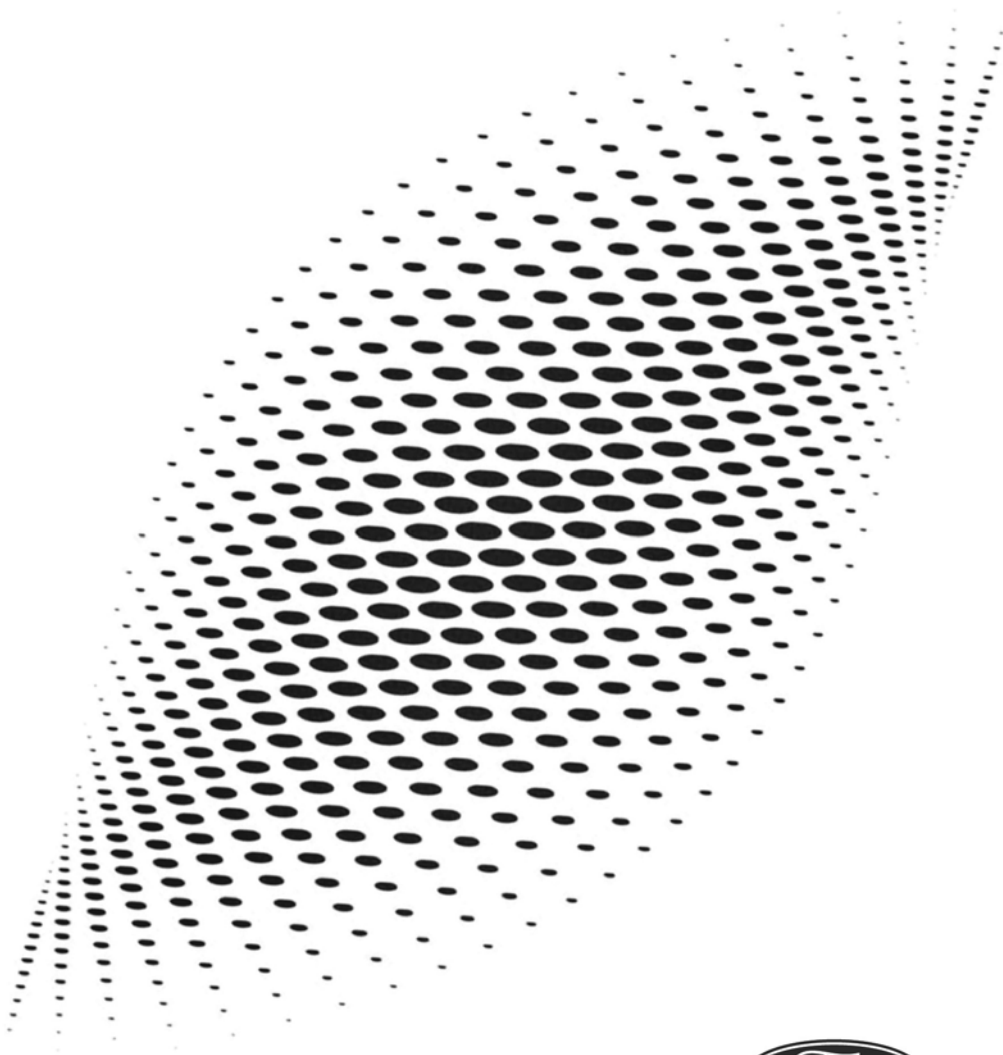

The information contained in this publication was correct at the time of release. In the interest of continuous development, we reserve the right to change specifications, design or equipment at any time without notice or obligation. No part of this publication may be reproduced, transmitted, stored in a retrieval system or translated into any language in any form by any means without our written permission. Errors and omissions excepted.

© Ford Motor Company 2024

All rights reserved.

Part Number: -202409-20240913181442

California Proposition 65



WARNING: Operating, servicing and maintaining a passenger vehicle or off-highway motor vehicle can expose you to chemicals including engine exhaust, carbon monoxide, phthalates, and lead, which are known to the State of California to cause cancer and birth defects or other reproductive harm. To minimize exposure, avoid breathing exhaust, do not idle the engine except as necessary, service your vehicle in a well-ventilated area and wear gloves or wash your hands frequently when servicing your vehicle. For more information go to www.P65Warnings.ca.gov/passenger-vehicle.



WARNING: Battery posts, terminals and related accessories contain lead and lead compounds, chemicals known to the State of California to cause cancer and reproductive harm.
Wash your hands after handling.

Table of Contents

Contacting Us

Contacting Us	17
---------------------	----

Introduction

About This Publication	19
Using This Publication	20

Symbols Glossary

Symbols Used on Your Vehicle	21
Symbols Used On Your Instrument Cluster	23

Data Privacy

Data Privacy	27
Service Data	28
Event Data	28
Settings Data	29
Connected Vehicle Data	29
Mobile Device Data	30
Emergency Call System Data	30

Environment

Protecting the Environment	31
----------------------------------	----

Visual Search

Interior Overview	32
Exterior Overview	33

Child Safety

Child Safety Precautions	34
Child Restraint Anchor Points	35
Child Restraints	37
Installing Child Restraints	38
Booster Seats	45
Child Safety Locks - Crew Cab/ SuperCab	47

Seatbelts

Seatbelt Precautions	48
----------------------------	----

Fastening and Unfastening the Seatbelts	49
Sensitive Locking Mode	50
Automatic Locking Mode	50
Adjusting the Seatbelts During Pregnancy	51
Adjusting the Seatbelt Height	51
Adjusting the Seatbelt Length	52
Seatbelt Reminder	52
Checking the Seatbelts	54
Seatbelt Extensions	54

Airbags

How Do the Front Airbags Work	55
How Do the Side Airbags Work	55
How Does the Safety Canopy™ Work	56
Airbag Precautions	57
Switching the Passenger Airbag On and Off	58
Properly Adjusting the Driver and Front Passenger Seats	62
Children and Airbags	62
Crash Sensors and Airbag Indicator	63
Disposing of Airbags	64

911 Assist

What Is 911 Assist	65
How Does 911 Assist Work	65
Emergency Call Requirements	65
Emergency Call Limitations	66
911 Assist Videos	66

Keys and Remote Controls

Remote Control Limitations	67
Using the Remote Control	67
Opening and Closing the Flip Key	68
Removing the Key Blade - Vehicles With: Push Button Start	68
Sounding the Panic Alarm	69
Locating Your Vehicle	69

Table of Contents

Changing the Remote Control Battery - Vehicles With: Flip Key	69
Changing the Remote Control Battery - Vehicles With: Push Button Start	70
Replacing a Lost Key or Remote Control	71
Programming the Remote Control - Vehicles With: Flip Key	72
Programming the Remote Control - Vehicles With: Push Button Start	73
Keys and Remote Controls Audible Warnings - Vehicles With: Push Button Start	74
Keys and Remote Controls Audible Warnings - Vehicles With: Flip Key	74
Keys and Remote Controls – Troubleshooting	74

Doors and Locks

Operating the Doors From Outside Your Vehicle	75
Operating the Doors From Inside Your Vehicle	75
Autounlock	76
Autolock	76
Mislock	76
Doors and Locks Audible Warnings	76
Doors and Locks – Troubleshooting	77

Keyless Entry

Keyless Entry Limitations	79
Keyless Entry Settings	79
Using Keyless Entry	79
Keyless Entry – Troubleshooting	80
Keyless Entry Videos	80

Easy Entry and Exit

How Does Easy Entry and Exit Work	81
Switching Easy Entry and Exit On and Off	81

Tailgate - Vehicles With: Manual Tailgate

Tailgate Precautions	82
Opening the Tailgate	82
Removing and Installing the Tailgate	82
Tailgate Step	83
Tailgate Videos	84

Tailgate - Vehicles With: Power Tailgate

Tailgate Precautions	85
Opening the Tailgate	85
Closing the Tailgate	85
Removing and Installing the Tailgate	86
Tailgate Step	88
Tailgate – Troubleshooting	89
Tailgate Videos	90

Tailgate - Vehicles With: Remote Power Tailgate Release

Tailgate Precautions	91
Opening the Tailgate	91
Removing and Installing the Tailgate	91
Tailgate Step	92
Tailgate – Troubleshooting	94
Tailgate Videos	95

Security

Passive Anti-Theft System	96
Anti-Theft Alarm System	96
Security – Troubleshooting	97

Power Running Boards

Power Running Board Precautions	99
Power Running Board Settings	99

Table of Contents

Power Running Boards – Troubleshooting	100	Exterior Lighting Videos	117
Steering Wheel		Interior Lighting	
Adjusting the Steering Wheel - Vehicles With: Manual Adjustable Steering Column	101	Switching All of the Interior Lamps On and Off	118
Adjusting the Steering Wheel - Vehicles With: Power Adjustable Steering Column	101	Switching the Front Interior Lamps On and Off	118
Resetting the Stopping Position - Vehicles With: Power Adjustable Steering Column	102	Switching the Rear Interior Lamps On and Off	118
Horn	102	Interior Lamp Function	118
Switching the Heated Steering Wheel On and Off - Vehicles With: Heated Steering Wheel	103	Adjusting the Instrument Panel Lighting Brightness	119
Adjustable Pedals		Ambient Lighting	119
Adjusting the Pedals	104	Interior Lighting – Troubleshooting	119
Wipers and Washers		Windows	
Wipers	105	Opening and Closing the Windows	120
Autowipers	105	Global Opening	120
Checking the Wiper Blades	106	Window Bounce-Back	121
Replacing the Front Wiper Blades	106	Locking the Rear Window Controls - Crew Cab/SuperCab	121
Washers	106	Opening and Closing the Sliding Windows - Vehicles With: Power Sliding Rear Window	121
Wipers and Washers Videos	108	Windows Videos	122
Wipers and Washers – Troubleshooting	108	Interior Mirror	
Exterior Lighting		Interior Mirror Precautions	123
Exterior Lighting Control	109	Manually Dimming the Interior Mirror	123
Headlamps	109	Auto-Dimming Interior Mirror	123
Headlamps – Troubleshooting	110	Exterior Mirrors	
Autolamps	110	Adjusting the Exterior Mirrors	124
Exterior Lamps	111	Folding the Exterior Mirrors - Vehicles With: Manual Folding Mirrors	124
Exterior Zone Lighting	113	Folding the Exterior Mirrors - Vehicles With: Power Folding Mirrors	124
Automatic High Beam Control	114	Extending the Exterior Mirrors	125
Automatic High Beam Control – Troubleshooting	116	Exterior Mirrors Videos	126
Adaptive Front Lighting	117		

Table of Contents

Glass Roof

Opening and Closing the Sunshade	127
Opening and Closing the Glass Roof	127
Venting the Glass Roof	128
Glass Roof Bounce-Back	128

Instrument Cluster

Instrument Cluster Overview - Vehicles With: 4.2 Inch Screen	129
Instrument Cluster Overview - Vehicles With: 12 Inch Screen	130
Tachometer	130
Speedometer	130
Fuel Gauge	130
Engine Coolant Temperature Gauge	131
Engine Oil Pressure Gauge	131
Engine Oil Temperature Gauge	131
Transmission Fluid Temperature Gauge	131
Turbo Boost Gauge	131
Diesel Exhaust Fluid Gauge	131

Instrument Cluster Display

Using the Instrument Cluster Display Controls	132
Instrument Cluster Display Main Menu - Vehicles With: 4.2 Inch Screen	132
Instrument Cluster Display Main Menu - Vehicles With: 12 Inch Screen	133
Customizing the Instrument Cluster Display - Vehicles With: 4.2 Inch Screen	133
Customizing the Instrument Cluster Display - Vehicles With: 12 Inch Screen	133

Trip Computer

Accessing the Trip Computer - Vehicles With: 4.2 Inch Screen	134
Accessing the Trip Computer - Vehicles With: 12 Inch Screen	134

Resetting the Trip Computer	134
Trip Data	134

Head Up Display

What Is the Head Up Display	135
Switching the Head Up Display On and Off	135
Head Up Display Settings	135
Head Up Display – Troubleshooting	136

Remote Start

Using Remote Start	137
Remote Start Settings	137

Climate Control - Vehicles With: Automatic Temperature Control

Identifying the Climate Control Unit	138
Switching Climate Control On and Off	138
Switching Recirculated Air On and Off	138
Switching Air Conditioning On and Off	138
Switching Defrost On and Off	138
Switching Maximum Defrost On and Off	138
Switching Maximum Cooling On and Off	139
Switching the Heated Rear Window On and Off	139
Setting the Blower Motor Speed	139
Switching the Heated Mirrors On and Off	139
Setting the Temperature	139
Directing the Flow of Air	140
Auto Mode	140
Climate Control Hints	140
Climate Control Videos	141
Air Conditioning System Refrigerant	141

Table of Contents

Climate Control - Vehicles With: Manual Temperature Control

Identifying the Climate Control Unit	143
Switching Climate Control On and Off	143
Switching Recirculated Air On and Off	143
Switching Air Conditioning On and Off	143
Switching Defrost On and Off	143
Switching Maximum Defrost On and Off	143
Switching Maximum Cooling On and Off	144
Switching the Heated Rear Window On and Off	144
Setting the Blower Motor Speed	144
Switching the Heated Mirrors On and Off	144
Setting the Temperature	145
Directing the Flow of Air	145
Climate Control Hints	145
Climate Control Videos	146

Interior Air Quality

What Is the Cabin Air Filter	147
Replacing the Cabin Air Filter	147

Front Seats

Front Seat Precautions	148
Sitting in the Correct Position	148
Manual Seats	149
Power Seats	151
Massage Seats	154
Heated Seats	155
Ventilated Seats	156

Rear Seats - Crew Cab/ SuperCab

Manual Seats	157
--------------------	-----

Heated Seats	159
--------------------	-----

Rear Occupant Alert System - Crew Cab/SuperCab

What is the Rear Occupant Alert System	161
How Does the Rear Occupant Alert System Work	161
Rear Occupant Alert System Precautions	161
Rear Occupant Alert System Limitations	161
Rear Occupant Alert System Settings	162
Rear Occupant Alert System Indicators	162
Rear Occupant Alert System Audible Warnings	163

Memory Function

What Is the Memory Function	164
Memory Function Precautions	164
Locating the Memory Function Buttons	164
Saving a Preset Position	164
Recalling a Preset Position	164

Garage Door Opener

Garage Door Opener Introduction	165
Garage Door Opener Precautions and Frequencies	165
Programming the Garage Door Opener	166
Garage Door Opener Additional Assistance	168

USB Ports

Locating the USB Ports	169
Playing Media Using the USB Port	169
Charging a Device	169

Table of Contents

Power Outlet - Vehicles With: 110V Power Outlet

What Is the Power Outlet	171
Power Outlet Precautions	171
Power Outlet Limitations	171
Locating the Power Outlets	171
Power Outlet Indicators	172

Power Outlet - Vehicles With: 12V Power Outlet

What Is the Power Outlet	173
Power Outlet Precautions	173
Locating the Power Outlets	173

Onboard Generator

What Is the Onboard Generator	174
Onboard Generator Precautions	174
Locating the Outlets	175
Onboard Generator Indicators	175
Switching the Outlets On and Off	176
What Is Utility Idle Mode - Vehicles With: Flip Key	177
Switching Utility Idle Mode On and Off - Vehicles With: Flip Key	177
What Is Generator Mode	177
Switching Generator Mode On and Off	177
Resetting Ground Fault Detection	177
Onboard Generator – Troubleshooting	178

Center Console Work Surface

Using the Center Console Work Surface	180
Center Console Work Surface – Troubleshooting	181

Wireless Accessory Charger

What Is the Wireless Accessory Charger	182
---	-----

Wireless Accessory Charger Precautions	182
Locating the Wireless Accessory Charger	182
Charging a Wireless Device	182
Wireless Accessory Charger Videos	183

Storage

Cup Holders	184
Glove Compartment	184
Center Console	185
Under Seat Storage	185
Glasses Holder	188

Starting and Stopping the Engine

Starting and Stopping the Engine – Precautions	189
Ignition Switch - Vehicles With: Keyed Ignition	189
Push Button Ignition Switch - Vehicles With: Push Button Start	190
Starting the Engine	190
Engine Block Heater	192
Stopping the Engine	193
Idle Timer	195
Automatic Engine Stop	195
Accessing the Passive Key Backup Position	196
Starting and Stopping the Engine – Troubleshooting	197

Fuel and Refueling

Fuel and Refueling Precautions	203
Fuel Quality	203
Running Out of Fuel	207
Refueling	207
Fuel Tank Capacity - Diesel	209
Fuel Tank Capacity - Gasoline	210
Fuel and Refueling – Troubleshooting	210

Table of Contents

Diesel Particulate Filter - Diesel

What Is the Diesel Particulate Filter	212
How Does the Diesel Particulate Filter Work	212
Diesel Particulate Filter Precautions	212
Diesel Particulate Filter Requirements	213
Diesel Particulate Filter Manual Regeneration	213
Diesel Particulate Filter – Troubleshooting	215

Selective Catalytic Reduction System - Diesel

What Is the Selective Catalytic Reduction System	217
How Does the Selective Catalytic Reduction System Work	217
Selective Catalytic Reduction System Precautions	217
Selective Catalytic Reduction System Requirements	219
Selective Catalytic Reduction System Guidelines	219
Filling the Selective Catalytic Reduction System Tank	219
Checking the Selective Catalytic Reduction System Status	221
Diesel Exhaust Fluid Capacity and Specification	221
Selective Catalytic Reduction System – Troubleshooting	222

Catalytic Converter

What Is the Catalytic Converter	225
Catalytic Converter Precautions	225
Catalytic Converter – Troubleshooting	225

Automatic Transmission

Automatic Transmission Positions	226
--	-----

Manually Shifting Gears	227
Using Power Take-Off	228
Automatic Transmission Audible Warnings	229
Using Progressive Range Selection	229
Automatic Transmission Fluid Capacity and Specification	229

Four-Wheel Drive

How Does Four-Wheel Drive Work - Excluding: Tremor	231
How Does Four-Wheel Drive Work - Tremor	232
Four-Wheel Drive Precautions	233
Four-Wheel Drive Limitations	233
Switching Four-Wheel Drive On and Off	234
Selecting a Four-Wheel Drive Mode	235
Four-Wheel Drive Modes	236
Four-Wheel Drive Indicators	236
Transfer Case Fluid Capacity and Specification	236
Four-Wheel Drive – Troubleshooting	237
Four-Wheel Drive Videos	239

Front Axle

Front Axle Fluid Capacity and Specification	240
---	-----

Rear Axle

Limited Slip Differential	242
Rear Axle Fluid Capacity and Specification	242

Electronic Locking Differential

What Is the Electronic Locking Differential	247
How Does the Electronic Locking Differential Work	247

Table of Contents

Electronic Locking Differential Precautions	247
Switching the Electronic Locking Differential On and Off - 4x4	247
Switching the Electronic Locking Differential On and Off - 4x2	249
Electronic Locking Differential Indicators	249
Electronic Locking Differential – Troubleshooting	250

Brakes

Brake Precautions	251
Anti-Lock Braking System	251
Brake Over Accelerator	251
Locating the Brake Fluid Reservoir	251
Checking the Brake Fluid	251
Brake Fluid Specification	252
Brakes – Troubleshooting	252

Electric Parking Brake

What Is the Electric Parking Brake	255
Applying the Electric Parking Brake	255
Applying the Electric Parking Brake in an Emergency	255
Manually Releasing the Electric Parking Brake	255
Automatically Releasing the Electric Parking Brake	256
Electric Parking Brake Audible Warning	256
Releasing the Electric Parking Brake if the Vehicle Battery Has Run Out of Charge	256
Electric Parking Brake – Troubleshooting	256

Diesel Engine Exhaust Brake

Diesel Engine Exhaust Brake – Precautions	258
Using the Diesel Engine Exhaust Brake	258

Diesel Engine Exhaust Brake Indicators	259
Diesel Engine Exhaust Brake Gauge	259
Diesel Engine Exhaust Brake – Troubleshooting	259

Reverse Brake Assist

What Is Reverse Brake Assist	260
How Does Reverse Brake Assist Work	260
Reverse Brake Assist Precautions	260
Switching Reverse Brake Assist On and Off	261
Overriding Reverse Brake Assist	261
Reverse Brake Assist Indicators	261
Reverse Brake Assist – Troubleshooting	262

Hill Start Assist

What Is Hill Start Assist	264
How Does Hill Start Assist Work	264
Hill Start Assist Precautions	264
Switching Hill Start Assist On and Off	264
Hill Start Assist – Troubleshooting	264
Hill Start Assist Videos	264

Traction Control

What Is Traction Control	265
How Does Traction Control Work	265
Switching Traction Control On and Off	265
Traction Control Indicator	265
Traction Control – Troubleshooting	266

Stability Control

How Does Stability Control Work	267
Switching Stability Control On and Off	268
Stability Control Indicator	269

Table of Contents

Trail Control

What Is Trail Control	270
Trail Control Limitations	270
Switching Trail Control On and Off	270
Setting the Trail Control Speed	270
Canceling the Set Speed	271
Trail Control Indicators	271
Trail Control – Troubleshooting	272

Trail Turn Assist

What Is Trail Turn Assist	273
Trail Turn Assist Precautions	273
Trail Turn Assist Limitations	273
Switching Trail Turn Assist On and Off	273
Trail Turn Assist Indicators	273
Trail Turn Assist – Troubleshooting	274

Hill Descent Control

What Is Hill Descent Control	275
How Does Hill Descent Control Work	275
Hill Descent Control Precautions	275
Switching Hill Descent Control On and Off	275
Setting the Hill Descent Speed	275
Hill Descent Control Indicator	275
Hill Descent Control – Troubleshooting	276
Hill Descent Control Videos	276

Steering

Hydraulic Power Steering	277
Steering – Troubleshooting	279

Parking Aids

Parking Aid Precautions	280
Switching Parking Aid On and Off - Vehicles With: Front Parking Aid	280
Switching Parking Aid On and Off - Vehicles With: Rear Parking Aid	281

Rear Parking Aid	281
Front Parking Aid	282
Parking Aid Indicators	283
Parking Aids – Troubleshooting	284
Parking Aids Videos	285

Rear View Camera

What Is the Rear View Camera	286
Rear View Camera Precautions	286
Locating the Rear View Camera	286
Rear View Camera Guide Lines	287
Rear View Camera Settings	287

360 Degree Camera

What Is the 360 Degree Camera	289
How Does the 360 Degree Camera Work	289
360 Degree Camera Precautions	289
Locating the 360 Degree Cameras	289
360 Degree Camera Guide Lines	290
360 Degree Camera Settings	291

Cruise Control

What Is Cruise Control	293
Switching Cruise Control On and Off	293
Setting the Cruise Control Speed	293
Canceling the Set Speed	294
Resuming the Set Speed	294
Cruise Control Indicators	294

Adaptive Cruise Control

How Does Adaptive Cruise Control With Stop and Go Work	295
Adaptive Cruise Control Precautions	295
Adaptive Cruise Control Limitations	296
Switching Adaptive Cruise Control On and Off	298

Table of Contents

Adaptive Cruise Control Automatic Cancellation	298
Setting the Adaptive Cruise Control Speed	298
Setting the Adaptive Cruise Control Gap	299
Canceling the Set Speed	300
Resuming the Set Speed	300
Overriding the Set Speed	301
Adaptive Cruise Control Indicators	302
Switching From Adaptive Cruise Control to Cruise Control	302
Lane Centering	302
Lane Centering – Troubleshooting	305
Predictive Speed Assist	306
Predictive Speed Assist – Troubleshooting	308
Adaptive Cruise Control – Troubleshooting	308
Adaptive Cruise Control Videos	309

Drive Mode Control

What Is Drive Mode Control	310
How Does Drive Mode Control Work	310
Selecting a Drive Mode	310
Drive Modes	310
Drive Mode Control – Troubleshooting	313

Lane Keeping System

What Is the Lane Keeping System	316
How Does the Lane Keeping System Work	316
Lane Keeping System Precautions	316
Lane Keeping System Limitations	316
Switching the Lane Keeping System On and Off	317
Switching the Lane Keeping System Mode	317
Lane Keeping System Settings	317
Alert Mode	317

Aid Mode	318
Alert and Aid Mode	318
Lane Keeping System Indicators	319
Blind Spot Assist	319
Blind Spot Assist with Trailer Coverage	320
Lane Keeping System – Troubleshooting	323

Blind Spot Information System

What Is Blind Spot Information System	326
How Does Blind Spot Information System Work	326
Blind Spot Information System Precautions	326
Blind Spot Information System Limitations	326
Blind Spot Information System Requirements	326
Switching Blind Spot Information System On and Off	327
Locating the Blind Spot Information System Sensors	327
Blind Spot Information System With Trailer Coverage	327
Blind Spot Information System Indicators	329
Blind Spot Information System – Troubleshooting	329

Exit Warning

What is Exit Warning	331
How Does Exit Warning Work	331
Exit Warning Precautions	331
Exit Warning Limitations	331
Exit Warning Indicators	332
Switching Exit Warning On and Off	332
Locating the Exit Warning Sensors	332
Exit Warning – Troubleshooting	333

Table of Contents

Cross Traffic Alert

What Is Cross Traffic Alert	334
How Does Cross Traffic Alert Work	334
Cross Traffic Alert Precautions	334
Cross Traffic Alert Limitations	335
Switching Cross Traffic Alert On and Off	336
Locating the Cross Traffic Alert Sensors	336
Cross Traffic Alert Indicators	336
Cross Traffic Alert – Troubleshooting	337

Pre-Collision Assist

What Is Pre-Collision Assist	338
How Does Pre-Collision Assist Work	338
Pre-Collision Assist Precautions	338
Pre-Collision Assist Limitations	339
Switching Pre-Collision Assist On and Off	340
Locating the Pre-Collision Assist Sensors	340
Distance Indication	341
Distance Alert	342
Automatic Emergency Braking	342
Evasive Steering Assist	343
Pre-Collision Assist – Troubleshooting	343

Speed Sign Recognition

What Is Speed Sign Recognition	346
How Does Speed Sign Recognition Work	346
Speed Sign Recognition Precautions	346
Speed Sign Recognition Limitations	346
Speed Sign Recognition Indicators	346
Speed Sign Recognition Settings	347
Speed Sign Recognition – Troubleshooting	347

Driver Alert

What Is Driver Alert	349
How Does Driver Alert Work	349
Driver Alert Precautions	349
Driver Alert Limitations	349
Switching Driver Alert On and Off	350
Driver Alert – Troubleshooting	350

Load Carrying

Load Carrying Precautions	351
Using a Slide-In Camper	352
Locating the Safety Compliance Certification Labels	352
What Is the Gross Axle Weight Rating	352
What Is the Gross Vehicle Weight Rating	353
What Is the Gross Combined Weight Rating	353
Calculating Payload	353
Calculating the Load Limit	354

Pickup Bed

Pickup Bed Precautions	356
Pickup Bed Anchor Points	356
Tailgate Anchor Points	357
Pickup Bed Videos	358

Connecting a Trailer

Connecting a Trailer Precautions	359
Hitches	359
Connecting a Trailer	362
Trailer Lighting Check	363
Connecting a Trailer – Troubleshooting	365

Towing a Trailer

Towing a Trailer Precautions	366
Trailer Brake Precautions	366
Towing a Trailer Limitations	367

Table of Contents

Loading Your Trailer	367
Trailer Towing Hints	368
Launching or Retrieving a Boat or Personal Watercraft	368
Towing Weights and Dimensions	369
Towing a Trailer – Troubleshooting	371
Towing a Trailer Videos	372

Integrated Trailer Brake Controller

What Is the Integrated Trailer Brake Controller	373
Integrated Trailer Brake Controller Precautions	373
Using the Integrated Trailer Brake Controller	373
Adjusting the Integrated Trailer Brake Controller Mode	375
Integrated Trailer Brake Controller – Troubleshooting	376

Trailer Sway Control

How Does Trailer Sway Control Work	378
Trailer Sway Control Precautions	378
Switching Trailer Sway Control On and Off	378

Trailer Hitching Assistance

What Is Trailer Hitching Assistance	379
How Does Trailer Hitching Assistance Work	379
Trailer Hitching Assistance Precautions	379
Trailer Hitching Assistance Limitations	380
Switching Trailer Hitching Assistance On and Off	380
Using Trailer Hitching Assistance	380
Trailer Hitching Assistance Indicators	381
Trailer Hitching Assistance – Troubleshooting	383

Smart Hitch

What Is Smart Hitch	385
How Does Smart Hitch Work	385
Smart Hitch Limitations	385
Using Smart Hitch	385

Onboard Scales

What Is Onboard Scales	387
How Does Onboard Scales Work	387
Onboard Scales Limitations	387
Using Onboard Scales	387

Trailer Backup Assistance

What is Trailer Backup Assistance	389
How Does Trailer Backup Assistance Work	389
Trailer Backup Assistance Precautions	389
Setting Up the Trailer Backup Assistance for a Conventional Trailer	389
Setting Up the Trailer Backup Assistance for a Fifth-Wheel or Gooseneck Trailer	393
Switching Trailer Backup Assistance On and Off	395
Using the Trailer Backup Assistance Controller	395
Using the Trailer Backup Assistance Views	396
Trailer Backup Assistance – Troubleshooting	398

Trailer Reverse Guidance

What Is Trailer Reverse Guidance	403
How Does Trailer Reverse Guidance Work	403
Trailer Reverse Guidance Precautions	403
Setting Up Trailer Reverse Guidance for a Conventional Trailer	403
Switching Trailer Reverse Guidance On and Off	406

Table of Contents

Using Trailer Reverse Guidance Views	407
Trailer Reverse Guidance – Troubleshooting	409

Off-Road Driving

Basic Off-Road Driving Techniques	414
Driving Through Water Limitations	415
After Driving Your Vehicle Off-Road	416

Driving Hints

Cold Weather Precautions - 6.7L Diesel	417
Cold Weather Precautions - 6.8L/7.3L	417
Driving on Snow and Ice	417
Breaking-In	418
Driving Economically	418
Driving Through Mud and Water	418
Floor Mats	419

Snow Plowing

Snow Plowing Precautions	420
Operating Your Vehicle With a Snowplow	420
Snowplow Mode - Vehicles With: Snow Plow Mode	421

Crash and Breakdown Information

Roadside Assistance	423
Switching the Hazard Flashers On and Off	424
Jump Starting the Vehicle	424
Post-Crash Alert System	426
Post-Collision Braking	427
Automatic Crash Shutoff	427
Recovery Towing	428
Transporting the Vehicle	429
Fail-Safe Cooling	429

Towing Your Vehicle

Towing Your Vehicle Precautions	431
Recreationally Towing Your Vehicle - 4x4	431
Recreationally Towing Your Vehicle - 4x2	433
Emergency Towing	433
Towing Your Vehicle – Troubleshooting	433

Fuses

Fuse Precautions	434
Under Hood Fuse Box	434
Battery Fuse Box	439
Interior Fuse Box	440
Identifying Fuse Types	444
Fuses – Troubleshooting	444

Maintenance

Maintenance Precautions	445
Opening and Closing the Hood	445
Under Hood Overview - 6.7L Diesel	446
Under Hood Overview - 6.8L, Gasoline	447
Under Hood Overview - 7.3L, Gasoline	448
Engine Oil	449
Engine Air Filter	457
Draining the Fuel Filter Water Trap - Diesel	459
Coolant	462
Changing the Fuel Filter - Diesel	467
Changing the Fuel Filter - Gasoline	467
Drive Belt Routing Overview - 6.7L Diesel, Vehicles With: 110-120V 2kW Pickup Bed Power Outlet/Dual Generators	467
Drive Belt Routing Overview - 6.7L Diesel, Vehicles With: Dual Generators	468
Drive Belt Routing Overview - 6.7L Diesel, Vehicles With: Single Generator	468

Table of Contents

Drive Belt Routing Overview - 6.8L, Gasoline, Vehicles With: Dual Generators	468
Drive Belt Routing Overview - 6.8L, Gasoline, Vehicles With: Single Generator	469
Drive Belt Routing Overview - 7.3L, Gasoline, Vehicles With: Dual Generators	469
Drive Belt Routing Overview - 7.3L, Gasoline, Vehicles With: Single Generator	470
12V Battery	470
12V Battery – Troubleshooting	473
Adjusting the Headlamps	473
Exterior Bulbs	475
Interior Bulbs	482

Vehicle Specifications

Engine Specifications - 6.7L Diesel	483
Engine Specifications - 6.8L, Gasoline	484
Engine Specifications - 7.3L, Gasoline	485
Motorcraft Parts - 6.7L Diesel	486
Motorcraft Parts - 6.8L, Gasoline	487
Motorcraft Parts - 7.3L, Gasoline	488

Vehicle Care

Cleaning Products	489
Cleaning the Exterior	490
Cleaning the Interior	493
Repairing Minor Paint Damage	495
Waxing Your Vehicle	495
Vehicle Care Videos	495

Storing Your Vehicle

Preparing Your Vehicle for Storage	496
Removing Your Vehicle From Storage	497

Wheel and Tire Information

Locating the Tire label	498
Department of Transportation Uniform Tire Quality Grades	498
Information on the Tire Sidewall	499
Glossary of Tire Terminology	504
Tire Replacement Requirements	505
Using Snow Chains	507

Tire Care

Checking the Tire Pressures	510
Inflating the Tires	510
Inspecting the Tire for Wear	514
Inspecting the Tire for Damage	514
Inspecting the Wheel Valve Stems	518
Tire Rotation	518

Tire Pressure Monitoring System

What Is the Tire Pressure Monitoring System	521
Tire Pressure Monitoring System Overview	521
Tire Pressure Monitoring System Precautions	522
Tire Pressure Monitoring System Limitations	522
Viewing the Tire Pressures	523
Resetting Tire Pressure Monitoring System	523
Tire Pressure Monitoring System – Troubleshooting	527

Changing a Road Wheel

Changing a Flat Tire	530
Wheel Nuts	540

Vehicle Identification

Vehicle Identification Number	542
-------------------------------------	-----

Table of Contents

Connected Vehicle

What Is a Connected Vehicle	543
Connected Vehicle Requirements	543
Connected Vehicle Limitations	543
Connecting the Vehicle to a Mobile Network	543
Connecting the Vehicle to a Wi-Fi Network	543
Connected Vehicle Settings	544
Connected Vehicle – Troubleshooting	544

Vehicle Hotspot

Setting Up a Vehicle Hotspot	546
Vehicle Hotspot Settings	546
Vehicle Hotspot – Troubleshooting	547

Audio System

Audio System Precautions	548
Identifying the Audio Unit	548
Switching the Audio Unit On and Off	548
Selecting the Audio Source	548
Media Control Buttons	548
Adjusting the Volume	549
Setting a Memory Preset	549
Muting the Audio	549
Adjusting the Sound Settings	549
Setting the Clock and Date	549
AM/FM Radio	550
Digital Radio	550
Satellite Radio	551
Audio System – Troubleshooting	554

Center Display

Center Display Overview	558
Status Bar	558
Information On Demand Screen	559
Feature Bar	559
Settings	560

Driver Assistance Menu	560
Rebooting the Center Display	560

Voice Interaction

Ford Assistant	562
----------------------	-----

Alexa Built-In

What is Alexa Built-In	564
Alexa Built-In Requirements	564
Signing In to Your Account	564
Using Alexa Built-In	564
Alexa Built-In Settings	564

Phone

Phone Precautions	566
Connecting Your Phone	566
Phone Menu	566
Making and Receiving a Phone Call	568
Sending and Receiving a Text Message	569
Switching Text Message Notification On and Off	570
Enabling Apps on a Mobile Device	570
Switching Apple CarPlay On and Off	571
Switching Android Auto™ On and Off	571

Bluetooth®

Connecting a Bluetooth® Device	572
Playing Media Using Bluetooth®	572

Personal Profiles

How Do Personal Profiles Work	573
Enabling or Disabling Personal Profiles	573
Creating a Personal Profile	573
Linking or Unlinking a Personal Profile	573
Selecting a Personal Profile	574
Deleting a Personal Profile	574

Table of Contents

Navigation

Connected Navigation	575
Accessing Navigation	575
Navigation Map Updates	575
Adjusting the Map	575
Live Traffic	575
Setting a Destination	575
Waypoints	576
Route Guidance	576
Trailer Towing Navigation	577

Vehicle Software Updates

Vehicle Software Updates	578
Software Update Settings	578
Software Update Indicators	579

Vehicle System Reset

Performing a System Reset	580
---------------------------------	-----

Accessories

Accessories	581
-------------------	-----

Auxiliary Switches

What Are the Auxiliary Switches	582
Locating the Auxiliary Switches	582
Locating the Auxiliary Switch Wiring	582
Identifying the Auxiliary Switch Wiring	583

Ford Protect

What Is Ford Protect	584
----------------------------	-----

Scheduled Maintenance

Scheduled Maintenance	586
General Maintenance Information	589

Customer Information

Rollover Warning	594
------------------------	-----

The Better Business Bureau Auto Line Program	594
The Mediation and Arbitration Program	595
Reporting Safety Defects in the United States	595
Reporting Safety Defects in Canada	596
Third Party Software Copyright Acknowledgment	597
Radio Frequency Certification Labels	597
Perchlorate	666
Replacement Parts Recommendation	666
Mobile Communications Equipment	667
Federal Highway Administration Regulation	667
End User License Agreement	668
Emission Law	693
Export Unique Options	694
Warranty Information	694

Appendices

Electromagnetic Compatibility	697
-------------------------------------	-----

Contacting Us

If you require assistance or clarification on policies or procedures, please contact the customer relationship center.

United States

Ford Motor Company
Customer Relationship Center
PO Box 6248
Dearborn, MI 48126
1-800-392-3673 (FORD)
TDD for the hearing impaired:
7-1-1 (where offered by your telephone
service provider)
www.ford.com/help/contact/

Ford Credit - US Only

Ford Credit offers a full range of financing and lease plans to help you acquire your vehicle. If you have financed or leased your vehicle through Ford Credit, thank you for your business.

For assistance call 1-800-727-7000, or for more information about Ford Credit and access to an account manager, visit www.ford.com/finance.

Canada

Customer Relationship Centre
Ford Motor Company of Canada Limited
P.O. Box 2000
Oakville, Ontario L6J 5E4
1-800-565-3673 (FORD)
TDD for the hearing impaired:
7-1-1 (where offered by your telephone
service provider)
www.ford.ca

Australia

Ford Motor Company of Australia Pty Ltd.
Customer Relationship Centre
Private Mail Bag 5
Campbellfield, Victoria, 3061
Telephone: (13 FORD) 13 3673
E-mail: foacust1@ford.com

New Zealand

Ford Motor Company
Attention: Customer Relationship Centre
Private Bag 76912
Manukau City 2241
Telephone: 0800 367 369 (FORDNZ)
E-mail: fnzcust@ford.com

China - Imported Vehicle

Customer Relationship Center
Telephone: 400-690-1886
Website: <https://www.ford.com.cn/>

China - Chang'An Ford

Customer Relationship Center
Telephone: 800-810-8168
Mobile: 400-887-7766
Website: <https://www.ford.com.cn/>

Asia Pacific Direct Markets (APDM)

E-mail: apemcrc@ford.com

Caribbean, Central America and Israel

Ford Motor Company
Ford Export Operations
Attention: Owner Relations
1555 Fairlane Drive
Fairlane Business Park #3
Allen Park, MI 48101
Fax: (313) 390-0804
Telephone: (800) 841-3673
E-mail: atnclien@ford.com

U.S. Virgin Islands and Puerto Rico

Ford Motor Company
Ford Export Operations
Attention: Owner Relations
1555 Fairlane Drive
Fairlane Business Park #3
Allen Park, MI 48101
Telephone: (800) 841-3673
E-mail: atnclien@ford.com

Contacting Us

Argentina

Telephone: 0800-888-3673

Brazil

Website: www.ford.com.br
Telephone: 0800-703-3673
E-mail: central@ford.com

North Africa

E-mail: nafcrc@ford.com

South Africa

Telephone: 0860011022
Email: fordcrc2@ford.com

Sub-Saharan Africa

E-mail: ssacrc@ford.com

Puerto Rico

Ford International Business Development,
Inc.
P.O. Box 11957
Caparra Heights Station
San Juan, PR 00922-1957
1-800-392-3673 (FORD)
Fax: (313) 390-0804
E-mail: prcac@ford.com
www.ford.com.pr

Middle East

Ford Middle East Customer Relationship
Center
P.O. Box 21740
Dubai, United Arab Emirates
Telephone: 80004441066
Toll-free number for the Kingdom of Saudi
Arabia: 8008443673
Mobily and Zain cell phone users in Saudi
Arabia: 800850078
Kuwait: 22280384
Local telephone number for Kuwait: +965
1 898900
Fax: +971 4 3327266
E-mail: menacac@ford.com
www.me.ford.com

South Korea

Customer Relationship Center
Telephone: +82-02-1600-6003
E-mail: infokr1@ford.com
Emergency Dispatch Service call:
080-300-3673

Philippines

Telephone: 02-88669408
Email: emailus@ford.com

Taiwan

Telephone: 0800-032100
705 Zhonghua Rd., Sec. 1
Zhongli District, Taoyuan, Taiwan, 32068

Thailand

Telephone: 1383
E-mail: fordthai@ford.com

Vietnam

Telephone: 1800588888
E-mail: fordvn@ford.com

Introduction

ABOUT THIS PUBLICATION



WARNING: Driving while distracted can result in loss of vehicle control, crash and injury. We strongly recommend that you use extreme caution when using any device that may take your focus off the road. Your primary responsibility is the safe operation of your vehicle. We recommend against the use of any hand-held device while driving and encourage the use of voice-operated systems when possible. Make sure you are aware of all applicable local laws that may affect the use of electronic devices while driving.



WARNING: You risk death, fire, or serious injury to yourself and others if you do not follow the instruction highlighted by the warning symbol.

Thank you for choosing Ford. We recommend that you take some time to get to know your vehicle in order to benefit from greater safety and pleasure from driving it. Use this publication, whether in-vehicle center display screen, print, in Ford mobile app or online, to familiarize yourself with the features on your vehicle.

Note: Use and operate your vehicle in line with all applicable laws and regulations.

Note: Pass on all printed owner's information when selling this vehicle.

Features and Options

This publication describes product features and options available throughout the range of available models, sometimes even before they are generally available. It could describe options that are not available on the vehicle you have purchased.

Providing Feedback

If you would like to provide feedback to the Owner's Manual team, please email us at OWNERMANUALFEEDBACK@ford.com.

You will not receive a direct email response. Your submission will be investigated and necessary changes will be made to the Owner's Manual content.

To help investigate your submission, please include the following information:

- Your vehicle model
- The country in which your vehicle was purchased
- The Owner's Manual section needing investigation

Illustrations

Note: Some of the illustrations in this publication could show features as used in different models, so could appear different to you on your vehicle.

Location of Components

This manual may qualify the location of a component as left-hand side or right-hand side. The side is determined when facing forward in the seat.

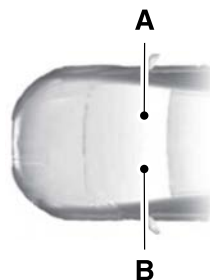

A Right-hand side.

B Left-hand side.

Introduction

Accessing the Digital Owner's Manual

The online version of the Owner's Manual may contain the very latest information, which may vary slightly from the in-vehicle digital Owner's Manual originally provided with your vehicle. We recommend updating the in-vehicle digital Owner's Manual when prompted using Over The Air updates.

Vehicles with a Portrait Center Display Screen

The Owner's Manual application is located in the Apps list.

Vehicles with a Landscape Center Display Screen

Depending on your vehicle, the Owner's Manual application is located in either the Apps list or the Features list.

Accessing the Online and Printed Owner's Manual

Online Owner's Manual

- Through your device's app store, you can download the Ford mobile app.
- You can visit the local Ford Website.

Note: To find the local Ford website, visit <https://corporate.ford.com/operations/locations/global-links.html>.

Note: We strongly recommend downloading a copy of the Owner's Manual and having it with you whenever you drive, and to view the information if you are unable to be inside the vehicle.

Printed Owner's Manual

In U.S. and Canada, visit www.helminc.com or see an authorized dealer.

In Europe, visit www.z-order.de or see an authorized dealer.

For all other Countries, see your authorized dealer.



USING THIS PUBLICATION

To quickly locate information about your vehicle, use the word search within the Owner's Manual application.

Symbols Glossary

SYMBOLS USED ON YOUR VEHICLE

These are some of the symbols you may see on your vehicle.

	Airbag		Child safety door lock or unlock
	Air conditioning system		Child seat lower anchor
	Air conditioning system lubricant type		Child seat tether anchor
	Anti-lock braking system		Cruise control
	Avoid smoking, flames or sparks		Do not open when hot
	Battery		Electric Parking brake
	Battery acid		Engine air filter
	Blower motor		Engine coolant
	Brake fluid - non petroleum based		Engine coolant temperature
	Brake system		Engine oil
	Brake system		Explosive gas
	Cabin air filter		Fan warning
	Check fuel cap		Fasten seatbelt
			Flammable
			Front fog lamps

Symbols Glossary



Fuel pump reset



Fuse compartment



Hazard flashers



Headlamp high beams



Headlamps on



Heated rear window



Hill descent control



Horn control



Interior luggage compartment release



Jack



Keep out of reach of children



Lighting control



Low fuel level



Low tire pressure warning



Maintain correct fluid level



Malfunction Indicator Lamp (MIL)



Note operating instructions



Panic alarm



Parking aid



Parking lamps



Passenger airbag activated



Passenger airbag deactivated



Power steering fluid



Power windows front/rear



Power window lockout



Requires registered technician



Safety alert



See Owner's Manual



See Service Manual



Side airbag

Symbols Glossary



Shield the eyes



Stability control



Stability control off



Trail control



Turn Signal



Windshield defrosting system



Windshield wiping system



Windshield wash and wipe

SYMBOLS USED ON YOUR INSTRUMENT CLUSTER

Depending on your vehicle options, market, and instrument cluster type, not all symbols shown are available.

Lighting and Signaling



High beams. See **Headlamp Indicators** (page 109).



Auto high beams. See **Automatic High Beam Control Indicators** (page 116).



Front fog lamps. See **Using the Front Fog Lamps** (page 112).



Turn signal - right. See **Using the Turn Signal Lamps** (page 111).



Turn signal - left. See **Using the Turn Signal Lamps** (page 111).



Positioning/side lights. See **Headlamp Indicators** (page 109).

Brakes



Brake failure. See **Brakes – Warning Lamps** (page 252). See **Electric Parking Brake – Warning Lamps** (page 256).



Brake failure. See **Brakes – Warning Lamps** (page 252). See **Electric Parking Brake – Warning Lamps** (page 256).



Electric parking brake fault. See **Electric Parking Brake – Warning Lamps** (page 256).



Anti-lock brake system malfunction. See **Brakes – Warning Lamps** (page 252).



Exhaust brake. See **Diesel Engine Exhaust Brake Indicators** (page 259).



Automatic exhaust brake. See **Diesel Engine Exhaust Brake Indicators** (page 259).

Visibility



Windshield washer fluid level. See **Wipers and Washers – Warning Lamps** (page 108).

Symbols Glossary

Engine



Check engine. See **Starting and Stopping the Engine – Warning Lamps** (page 197).

See **Catalytic Converter – Warning Lamps** (page 225). See **Coolant – Warning Lamps** (page 466). See **Emission Law** (page 693). See **Starting Diesel Particulate Filter Manual Regeneration** (page 214). See **Diesel Particulate Filter – Warning Lamps** (page 215).



Engine oil pressure. See **Starting and Stopping the Engine – Warning Lamps**

(page 197).



Engine coolant temperature. See **Catalytic Converter – Warning Lamps** (page 225).

See **Coolant – Warning Lamps** (page 466).



Diesel exhaust fluid. See **Selective Catalytic Reduction System – Warning Lamps**

(page 222).



Diesel pre-heat. See **Starting a Diesel Engine** (page 191). See **Starting a Diesel Engine** (page 191).

Fuel



Fuel. See **Fuel and Refueling – Warning Lamps** (page 210).



Water/Moisture in fuel system. See **Draining the Fuel Filter Water Trap** (page 459).

Transmission



Non-emission powertrain fault. See **Starting and Stopping the Engine – Warning Lamps** (page 197). See **Four-Wheel Drive – Warning Lamps** (page 237). See **Diesel Particulate Filter – Warning Lamps** (page 215).

Vehicle Handling



Selectable drive mode - normal. See **Normal** (page 311). See **Normal** (page 311).



Selectable drive mode - ECO. See **Eco** (page 310). See **Eco** (page 311).



Selectable drive mode - tow/haul. See **Tow/Haul** (page 313). See **Tow/Haul** (page 313).



Selectable drive mode - slippery. See **Slippery** (page 312). See **Slippery** (page 312).



Selectable drive mode - trail. See **Trail** (page 313).



Selectable drive mode - rock crawl. See **Rock Crawl** (page 312).



Selectable drive mode - Off-road. See **Off-Road** (page 311).



Steering system fault. See **Steering – Information Messages** (page 279).



Differential lock - rear axle. See **Electronic Locking Differential Indicators** (page 249).

Symbols Glossary



Off road turn assist - right. See **Trail Turn Assist Indicators** (page 273).



Off road turn assist - left. See **Trail Turn Assist Indicators** (page 273).



Two-wheel drive high. See **Four-Wheel Drive Indicators** (page 236).



Four-wheel drive high. See **Four-Wheel Drive Indicators** (page 236).



Four-wheel drive low. See **Four-Wheel Drive Indicators** (page 236).

Driver Assistance



Cruise control. See **Switching From Adaptive Cruise Control to Cruise Control** (page 302).



Adaptive cruise control. See **Adaptive Cruise Control Indicators** (page 302).



Hill descent control. See **Hill Descent Control Indicator** (page 275).



Trail control. See **Traction Control Indicator** (page 265).



Lane centering assist. See **Lane Centering Indicators** (page 305).

Safety



Seatbelt. See **Seatbelt Reminder Indicators** (page 53). See **Seatbelt Precautions** (page 48).



Airbag. See **How Does the Safety Canopy™ Work** (page 56). See **Crash Sensors and Airbag Indicator** (page 63). See **Seatbelt Precautions** (page 48).



Stability control system active or not available. See **Traction Control Indicator** (page 265). See **Stability Control Indicator** (page 269).



Stability control system off. See **Traction Control Indicator** (page 265). See **Drive Mode Control – Warning Lamps** (page 313).



Tire failure/Low tire pressure. See **What Is the Tire Pressure Monitoring System** (page 521). See **Tire Pressure Monitoring System – Warning Lamps** (page 527).



Forward collision warning system. See **How Does Pre-Collision Assist Work** (page 338).



Blind spot information system off or unavailable. See **Blind Spot Information System Indicators** (page 329).



Forward collision warning system off or unavailable. See **Pre-Collision Assist – Warning Lamps** (page 343).



Door(s) ajar. See **Doors and Locks – Warning Lamps** (page 77).

Security



Hood release/ajar. See **Opening and Closing the Hood** (page 445).

Symbols Glossary



Tailgate release/ajar. See **Tailgate – Warning Lamps** (page 89).

Electrical Systems



Battery charge level. See **12V Battery – Warning Lamps** (page 473). See **Catalytic Converter – Warning Lamps** (page 225).

Data Privacy



WARNING: Do not connect wireless plug-in devices to the data link connector. Unauthorized third parties could gain access to vehicle data and impair the performance of safety related systems. Only allow repair facilities that follow our service and repair instructions to connect their equipment to the data link connector.

We respect your privacy and are committed to protecting it. The information contained in this publication was correct at the time of release, but as technology rapidly changes, we recommend that you visit the local Ford website for the latest information.

Your vehicle has electronic control units that have data recording functionality and the ability to permanently or temporarily store data. This data could include information on the condition and status of your vehicle, vehicle maintenance requirements, events and malfunctions. The types of data that can be recorded are described in this section. Some of the data recorded is stored in event logs or error logs.

Note: *Error logs are reset following a service or repair.*

Note: *We may provide information in response to requests from law enforcement, other government authorities and third parties acting with lawful authority or through a legal process. Such information could be used by them in legal proceedings.*

Data recorded includes, for example:

- Operating states of system components, for example fuel level, tire pressure and battery charge level.
- Vehicle and component status, for example wheel speed, deceleration, lateral acceleration and seatbelt status.

- Events or errors in essential systems, for example headlamps and brakes.
- System responses to driving situations, for example airbag deployment and stability control.
- Environmental conditions, for example temperature.

Some of this data, when used in combination with other information, for example an accident report, damage to a vehicle or eyewitness statements, could be associated with a specific person.

Services That We Provide

If you use our services, we collect and use data, for example account information, vehicle location and driving characteristics, that could identify you. We transmit this data through a dedicated, protected connection. We only collect and use data to enable your use of our services to which you have subscribed, with your consent or where permitted by law. For additional information, see the terms and conditions of the services to which you have subscribed.

For additional information about our privacy policy, refer to the local Ford website.

Services That Third Parties Provide

We recommend that you review the terms and conditions and data privacy information for any services equipped with your vehicle or to which you subscribe. We take no responsibility for services that third parties provide.

Where equipped, SiriusXM with 360L could use the modem. To disable, turn off the SiriusXM with 360L or Vehicle Connectivity setting. See **Enabling and Disabling the Modem** (page 543).

Data Privacy

SERVICE DATA

Service data recorders in your vehicle are capable of collecting and storing diagnostic information about your vehicle. This potentially includes information about the performance or status of various systems and modules in the vehicle, such as engine, throttle, steering or brake systems. In order to properly diagnose and service your vehicle, Ford Motor Company (Ford of Canada in Canada), and service and repair facilities may access or share among them vehicle diagnostic information received through a direct connection to your vehicle when diagnosing or servicing your vehicle. Additionally, Ford Motor Company (Ford of Canada, in Canada) may, where permitted by law, use vehicle diagnostic information for vehicle improvement or with other information we may have about you, for example, your contact information, to offer you products or services that may interest you. Data may be provided to our service providers such as part suppliers that may help diagnose malfunctions, and who are similarly obligated to protect data. We retain this data only as long as necessary to perform these functions or to comply with law. We may provide information where required in response to official requests to law enforcement or other government authorities or third parties acting with lawful authority or court order, and such information may be used in legal proceedings. For U.S. only (if equipped), if you choose to use connected apps and services, you consent that certain diagnostic information may also be accessed electronically by Ford Motor Company and Ford authorized service facilities, and that the diagnostic information may be used to provide services to you, personalizing your experience, troubleshoot, and to improve products and services and offer you products and services that may interest

you, where permitted by law. For Canada only, for more information, please review the Ford of Canada privacy policy at www.ford.ca, including our U.S. data storage and use of service providers in other jurisdictions who may be subject to legal requirements in Canada, the United States and other countries applicable to them, for example, lawful requirements to disclose personal information to governmental authorities in those countries.

EVENT DATA

This vehicle is equipped with an event data recorder. The main purpose of an event data recorder is to record, in certain crash or near crash-like situations, such as an airbag deployment or hitting a road obstacle; this data will assist in understanding how a vehicle's systems performed. The event data recorder is designed to record data related to vehicle dynamics and safety systems for a short period of time, typically 30 seconds or less.

The event data recorder in this vehicle is designed to record such data as:

- How various systems in your vehicle were operating.
- Whether or not the driver and passenger seatbelts were buckled/fastened.
- How far (if at all) the driver was depressing the accelerator and/or the brake pedal.
- How fast the vehicle was traveling.
- Where the driver was positioning the steering wheel.

This data can help provide a better understanding of the circumstances in which crashes and injuries occur.

Data Privacy

Note: Event data recorder data is recorded by your vehicle only if a non-trivial crash situation occurs; no data is recorded by the event data recorder under normal driving conditions and no personal data or information (for example name, gender, age, and crash location) is recorded. However, parties, such as law enforcement, could combine the event data recorder data with the type of personally identifying data routinely acquired during a crash investigation.

To read data recorded by an event data recorder, special equipment is required, and access to the vehicle or the event data recorder is needed. In addition to the vehicle manufacturer, other parties, such as law enforcement, that have such special equipment, can read the information if they have access to the vehicle or the event data recorder.

SETTINGS DATA

Your vehicle has electronic control units that have the ability to store data based on your personalized settings. The data is stored locally in the vehicle or on devices that you connect to it, for example, a USB drive or digital music player. You can delete some of this data and also choose whether to share it through the services to which you subscribe.

Comfort and Convenience Data

Data recorded includes, for example:

- Seat and steering wheel position.
- Climate control settings.
- Radio presets.

Entertainment Data

Data recorded includes, for example:

- Music, videos or album art.
- Contacts and corresponding address book entries.
- Navigation destinations.

CONNECTED VEHICLE DATA



The modem has a SIM. The modem was enabled when your vehicle was built and periodically sends messages to stay connected to the cell phone network, receive automatic software updates and send vehicle-related information to us, for example diagnostic information. These messages could include information that identifies your vehicle, the SIM and the electronic serial number of the modem. Cell phone network service providers could have access to additional information, for example cell phone network tower identification. For additional information about our privacy policy, visit www.FordConnected.com or refer to your local Ford website.

Note: The modem continues to send this information unless you disable the modem or stop the modem from sharing vehicle data by changing the modem settings. See **Connected Vehicle** (page 543).

Note: The service can be unavailable or interrupted for a number of reasons, for example environmental or topographical conditions and data plan coverage.

Note: To find out if your vehicle has a modem, visit www.FordConnected.com.

Data Privacy

MOBILE DEVICE DATA

If you connect a mobile device to your vehicle, you can display data from your device on the touchscreen for example, music and album art. You can share your vehicle data with mobile apps on your device through the system. See **Enabling Apps on a Mobile Device** (page 570).

The mobile apps function operates by your connected device sending data to us in the United States. The data is encrypted and includes, for example, the vehicle identification number of your vehicle, the SYNC module serial number, odometer, enabled apps, usage statistics and debugging information. We retain it only as long as necessary to provide the service, to troubleshoot, for continuous improvement and to offer you products and services that may be of interest to you according to your preferences and where allowed by law.

If you connect a cell phone to the system, the system creates a profile that links to that cell phone. The cell phone profile enables more mobile features and efficient operation. The profile contains, for example data from your phonebook, read and unread text messages and call history, including history of calls when your cell phone was not connected to the system.

If you connect a media device, the system creates and retains a media device index of supported media content. The system also records a short diagnostic log of approximately 10 minutes of all recent system activity.

The cell phone profile, media device index and diagnostic log remain in your vehicle unless you delete them and are generally accessible only in your vehicle when you connect your cell phone or media device. If you no longer plan to use the system or your vehicle, we recommend you use the system reset function to erase the stored information. See **Performing a System Reset** (page 580).

System data cannot be accessed without special equipment and access to your vehicle's module.

For additional information about our privacy policy, refer to the local Ford website.

Note: *To find out if your vehicle has connectivity technology, visit www.FordConnected.com.*

EMERGENCY CALL SYSTEM DATA

When the emergency call system is active, it may disclose to emergency services that your vehicle has been in a crash involving the deployment of an airbag or activation of the fuel pump shut-off. Certain versions or updates to the emergency call system may also be capable of electronically or verbally disclosing to emergency services operators your vehicle location or other details about your vehicle or crash to assist emergency services operators to provide the most appropriate emergency services. If you do not want to disclose this information, do not activate the emergency call system.

Note: *You cannot deactivate emergency call systems that are required by law.*

Environment

PROTECTING THE ENVIRONMENT

Sustainability is a priority at Ford. We are constantly looking for ways to reduce our impact on the planet while providing customers with great products and delivering a strong business. You should play your part in protecting the environment. Correct vehicle usage and the authorized disposal of waste, cleaning and lubrication materials are significant steps toward this aim.

For additional information about our sustainability progress and initiatives, visit www.sustainability.ford.com.

Visual Search

INTERIOR OVERVIEW

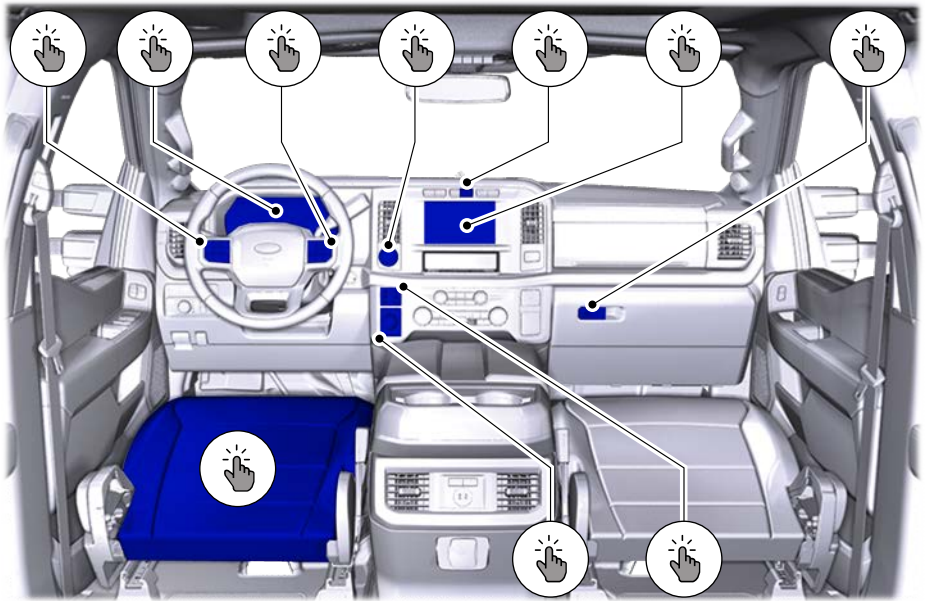

- A See **Switching Cruise Control On and Off** (page 293). See **Switching Adaptive Cruise Control On and Off** (page 298).
- B See **Instrument Cluster Overview** (page 129). See **Instrument Cluster Overview** (page 130).
- C See **Using the Instrument Cluster Display Controls** (page 132).
- D See **Using the Trailer Backup Assistance Controller** (page 395).
- E See **Switching the Hazard Flashers On and Off** (page 424).
- F See **Center Display Overview** (page 558).
- G See **Opening the Glove Compartment** (page 184).
- H See **Using the Integrated Trailer Brake Controller** (page 373).
- I See **Selecting a Four-Wheel Drive Mode** (page 235).
- J See **Sitting in the Correct Position** (page 148).

Visual Search

EXTERIOR OVERVIEW

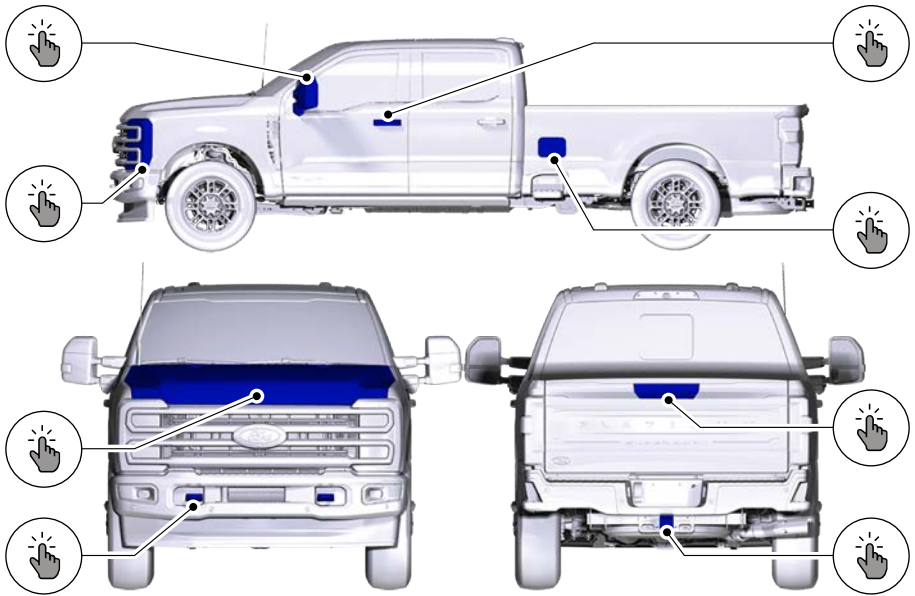

- A See **Folding the Exterior Mirrors** (page 124). See **Folding the Exterior Mirrors** (page 124).
- B See **Unlocking and Locking the Doors Using the Key Blade** (page 75).
- C See **Refueling Your Vehicle** (page 208).
- D See **Opening the Tailgate From Outside Your Vehicle** (page 82). See **Opening the Tailgate From Outside Your Vehicle** (page 85). See **Opening the Tailgate From Outside Your Vehicle** (page 91).
- E See **Connecting a Trailer** (page 362).
- F See **Accessing the Front Towing Point** (page 428).
- G See **Opening and Closing the Hood** (page 445).
- H See **Using the High Beam Headlamps** (page 109).

Child Safety

CHILD SAFETY PRECAUTIONS



WARNING: Always make sure your child is secured properly in a device that is appropriate for their height, age and weight. Child safety restraints must be bought separately from your vehicle. Failure to follow these instructions and guidelines may result in an increased risk of serious injury or death to your child.



WARNING: All children are shaped differently. The National Highway Traffic Safety Administration and other safety organizations, base their recommendations for child restraints on probable child height, age and weight thresholds, or on the minimum requirements of the law. We recommend that you check with a NHTSA Certified Child Passenger Safety Technician (CPST) to make sure that you properly install the child restraint in your vehicle and that you consult your pediatrician to make sure you have a child restraint appropriate for your child. To locate a child restraint fitting station and CPST, contact NHTSA toll free at 1-888-327-4236 or go to www.nhtsa.dot.gov. In Canada, contact Transport Canada toll free at 1-800-333-0371 or go to www.tc.gc.ca to find a Child Car Seat Clinic in your area. Failure to properly restrain children in child restraints made especially for their height, age and weight, may result in an increased risk of serious injury or death to your child.



WARNING: On hot days, the temperature inside the vehicle can rise very quickly. Exposure of people or animals to these high temperatures for even a short time can cause death or serious heat related injuries, including brain damage. Small children are particularly at risk.



WARNING: Do not place a rearward facing child restraint in front of an active airbag. Failure to follow this instruction could result in personal injury or death.



WARNING: Properly secure children 12 years old and under in a rear seating position whenever possible. If you are unable to properly secure all children in a rear seating position, properly secure the largest child on the front seat. If you must use a forward facing child restraint on the front seat, move the seat as far back as possible. Failure to follow these instructions could result in personal injury or death.



WARNING: Always carefully follow the instructions and warnings provided by the manufacturer of any child restraint to determine if the restraint device is appropriate for your child's size, height, weight, or age. Follow the child restraint manufacturer's instructions and warnings provided for installation and use in conjunction with the instructions and warnings provided by your vehicle manufacturer. A safety seat that is improperly installed or utilized, is inappropriate for your child's height, age, or weight or does not properly fit the child may increase the risk of serious injury or death.

Child Safety

WARNING: Do not allow a passenger to hold a child on their lap when your vehicle is moving. Failure to follow this instruction could result in personal injury or death in the event of a sudden stop or crash.

WARNING: Do not use pillows, books or towels to boost your child's height. Failure to follow this instruction could result in personal injury or death.

WARNING: Properly secure child restraints or booster seats when they are not in use. They could become projectiles in a sudden stop or crash. Failure to follow this instruction could result in personal injury or death.

WARNING: Do not put the shoulder section of the seatbelt or allow the child to put the shoulder section of the seatbelt under their arm or behind their back. Failure to follow this instruction could reduce the effectiveness of the seatbelt and increase the risk of injury or death in a crash.

WARNING: Do not leave children or pets unattended in your vehicle. Failure to follow this instruction could result in personal injury or death.

When installing a child restraint with seatbelts:

- Place the vehicle seat in the upright position before you install the child restraint.
- Use the correct seatbelt buckle for that seating position.
- Insert the belt tongue into the buckle. Make sure the tongue is securely fastened in the buckle.

- Keep the buckle release button pointing up and away from the child restraint, with the tongue between the child restraint and the release button, to prevent accidental unbuckling.
- Put the seatbelt in the automatic locking mode.

CHILD RESTRAINT ANCHOR POINTS

WHAT ARE THE CHILD RESTRAINT ANCHOR POINTS

Anchor points allow you to quickly and safely install a child restraint.

LOCATING THE CHILD RESTRAINT LOWER ANCHOR POINTS

Crew Cab



Super Cab

Child Safety

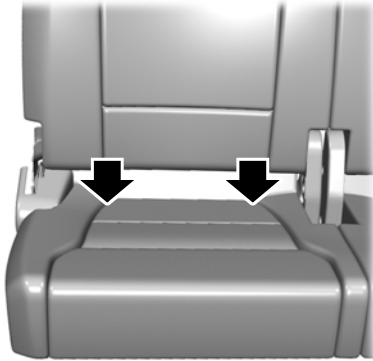
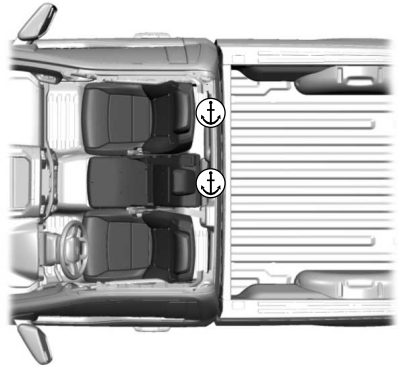
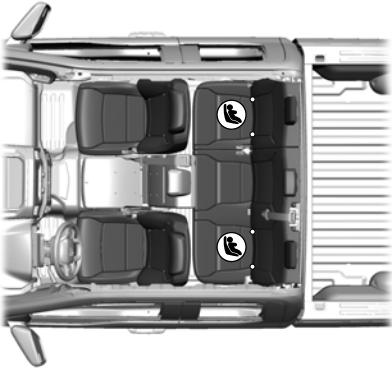

Crew Cab

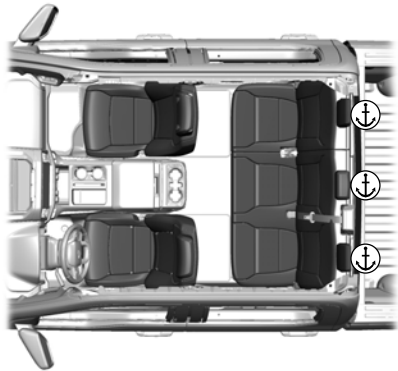

Super Cab

The lower child restraint anchors are at the rear section of the rear seat between the cushion and seat backrest.

Note: *Regular Cab* vehicles do not have lower anchors.

LOCATING THE CHILD RESTRAINT TOP TETHER ANCHOR POINTS

Regular Cab

Child Safety

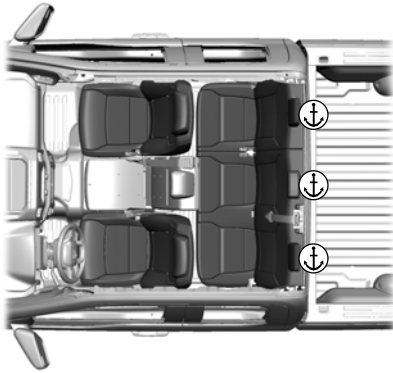

CHILD RESTRAINTS

CHILD RESTRAINT POSITION INFORMATION

Install the child restraint tightly against the vehicle seat. It may be necessary to lift or remove the head restraint.

Rear Facing Child Restraints

Combined Weight of Child and Child Restraint	LATCH (Lower Anchors Only)	Seatbelt Only
Up to 29 kg (65 lb)	X	X
Over 29 kg (65 lb)		X

Forward Facing Child Restraints

Combined Weight of Child and Child Restraint	LATCH (Lower Anchors and Top Tether Anchor)	Seatbelt and Top Tether Anchor	Seatbelt and LATCH (Lower Anchors and Top Tether Anchor)
Up to 29 kg (65 lb)	X	X	X
Over 29 kg (65 lb)		X	X

Child Safety

CHILD RESTRAINTS RECOMMENDATION

Child Size, Height, Weight, or Age	Recommended Restraint Type
Children weighing 18 kg (40 lb) or less (generally age four or younger).	Use a child restraint (sometimes called an infant carrier, convertible seat, or toddler seat).
Children who have outgrown or no longer properly fit in a child restraint (generally children who are less than 1.45 m (57 in) tall, are greater than age four and less than age 12, and between 18 kg (40 lb) and 36 kg (80 lb) and upward to 45 kg (100 lb) if recommended by your child restraint manufacturer).	Use a belt-positioning booster seat.
Children who have outgrown or no longer properly fit in a belt-positioning booster seat (generally children who are at least 1.45 m (57 in) tall or greater than 36 kg (80 lb) or 45 kg (100 lb) if recommended by child restraint manufacturer).	Use a vehicle seatbelt having the lap belt snug and low across the hips, shoulder belt centered across the shoulder and chest, and seat backrest upright.

You are required by law to properly use child restraints for infants and toddlers in the United States, Canada and Mexico.

Many states and provinces require that small children use approved booster seats until they reach age eight, a height of 1.45 m (57 in) tall, or 36 kg (80 lb). Check your local and state or provincial laws for specific requirements about the safety of children in your vehicle.

When possible, properly restrain children 12 years of age and under in a rear seating position of your vehicle. Accident statistics suggest that children are safer when properly restrained in the rear seating positions than in a front seating position.

When installing a rear facing child restraint, adjust the vehicle seats to avoid interference between the child restraint and the vehicle seat in front of the child restraint.

INSTALLING CHILD RESTRAINTS

USING SEATBELTS



WARNING: Depending on where you secure a child restraint, and depending on the child restraint design, you may block access to certain seatbelt buckle assemblies and LATCH lower anchors, rendering those features potentially unusable. To avoid risk of injury, make sure occupants only use seating positions where they are able to be properly restrained.

Note: *The following does not apply to the front center position of Super Cab and Crew Cab vehicles.*

Note: *Although the child restraint illustrated is a forward facing child restraint, the steps are the same for installing a rear facing child restraint.*

Child Safety

Perform the following steps when installing a child restraint with seatbelts.

1. Position the child restraint in a seat with a seatbelt.



2. Pull down on the shoulder belt and then grasp the shoulder belt and lap belt together.



3. While holding the shoulder and lap belt portions together, route the tongue through the child restraint according to the child restraint manufacturer's instructions. Make sure you did not twist the belt webbing.

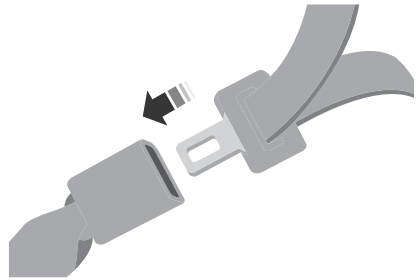

4. Insert the belt tongue into the proper buckle for that seating position until the latch engages. Make sure the tongue is latched securely by pulling on it.



5. To put the retractor in the automatic locking mode, grasp the shoulder portion of the belt and pull downward until you pull all of the seatbelt out.

Note: *The automatic locking mode is available on the front passenger and rear seats. This mode is also available on the center seat of a Regular Cab. This vehicle does not require the use of a locking clip.*

6. Allow the belt to retract to remove slack. The seatbelt clicks as it retracts to indicate it is in the automatic locking mode.

Child Safety

7. Pull the seatbelt out of the retractor to make sure the retractor is in the automatic locking mode. You should not be able to pull more belt out. If the retractor is not locked, unbuckle the belt and repeat Steps 5 and 6.



8. Remove remaining slack from the belt. Force the seat down with extra weight, for example, by pressing down or kneeling on the child restraint while pulling up on the shoulder belt in order to force slack from the belt. This is necessary to remove the remaining slack that exists once you add the extra weight of the child to the child restraint. It also helps to achieve the proper snugness of the child restraint to your vehicle. Sometimes, a slight lean toward the buckle helps to remove remaining slack from the belt.
9. If the child restraint has a tether strap, attach it.

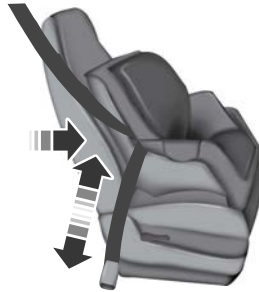

10. Before placing the child in the seat, forcibly move the seat forward and back to make sure the seat is securely held in place.

To check this, grab the seat at the belt path and attempt to move it side to side and forward and back. There should be no more than 2.5 cm (1 in) of movement.

We recommend checking with a NHTSA Certified Child Passenger Safety Technician to make certain the child restraint is properly installed. In Canada, check with Transport Canada for referral to a Child Car Seat Clinic.

Using Seatbelts



WARNING: Always use both the lap and shoulder portion of the seatbelt in the center seating position.

Note: *The following applies to the front center position of Super Cab and Crew Cab vehicles.*

The seatbelt webbing below the tongue is the lap portion of the seatbelt. The webbing above the tongue is the shoulder belt portion of the seatbelt.

1. Position the child restraint in the front center seat.

Child Safety



2. Slide the tongue up the webbing.



3. While holding both shoulder and lap portions next to the tongue, route the tongue and webbing through the child restraint according to the child restraint manufacturer's instructions. Make sure you did not twist the belt webbing.

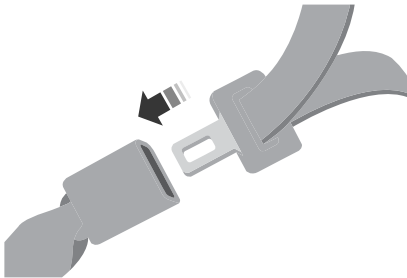

4. Insert the belt tongue into the proper buckle for that seating position until the latch engages. Make sure the tongue is latched securely by pulling on it.



5. When pushing down with your knee on the child restraint, pull up on the shoulder belt portion to tighten the lap belt portion of the seatbelt.
6. Allow the seatbelt to retract and remove any slack in the belt to securely tighten the child restraint in the vehicle.
7. If the child restraint has a tether strap, attach it.

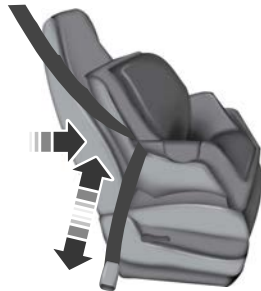

Child Safety

- Before placing the child in the seat, forcibly move the seat forward and back to make sure the seat is securely held in place. To check this, grab the seat at the belt path and attempt to move it side to side and forward and back. There should be no more than 2.5 cm (1 in) of movement.
- Check from time to time to be sure that there is no slack in the lap and shoulder belt. The shoulder belt must be snug to keep the lap belt tight during a crash.

We recommend checking with a NHTSA Certified Child Passenger Safety Technician to make certain the child restraint is properly installed. In Canada, check with Transport Canada for referral to a Child Car Seat Clinic.

USING LOWER ANCHORS AND TETHERS FOR CHILDREN



WARNING: Do not attach two child safety restraints to the same anchor. In a crash, one anchor may not be strong enough to hold two child safety restraint attachments and may break, causing serious injury or death.



WARNING: Depending on where you secure a child restraint, and depending on the child restraint design, you may block access to certain seatbelt buckle assemblies and LATCH lower anchors, rendering those features potentially unusable. To avoid risk of injury, make sure occupants only use seating positions where they are able to be properly restrained.

The Lower Anchors and Tethers for Children (LATCH) system has three vehicle anchor points:

- Two lower anchors where the vehicle seat backrest and seat cushion meet, called the seat bight.
- One top tether anchor behind that seating position.

LATCH compatible child restraints have two rigid or webbing mounted attachments. These attachments connect to the two lower anchors at the LATCH equipped seating positions in your vehicle. This type of attachment method eliminates the need to use seatbelts to attach the child restraint.

However, you can still use the seatbelt to attach the child restraint if the lower anchors are not used. For forward-facing child restraints, you must also attach the top tether strap to the proper top tether anchor if a top tether strap has been provided with your child restraint.

Follow the instructions later in this chapter on attaching child restraints with tether straps.

INSTALLING A CHILD RESTRAINT IN A CENTER SEAT



WARNING: The standardized spacing for LATCH lower anchors is 280 mm (11 in) center to center. Do not use LATCH lower anchors for the center seating position unless the child restraint manufacturer's instructions permit and specify using anchors spaced at least as far apart as those in this vehicle.

The lower anchors at the center of the second row rear seat are spaced 652 mm (25.7 in) apart. The standardized spacing for LATCH lower anchors is 280 mm (11 in) center to center.

Child Safety

You cannot install a child restraint with rigid LATCH attachments at the center seating position. You can only use LATCH compatible child restraints with attachments on belt webbing at this seating position provided that the child restraint manufacturer's instructions permit use with the anchor spacing stated. Do not attach a child restraint to any lower anchor if another child restraint is attached to that anchor.

Each time you use the child restraint, check that the seat is properly attached to the lower anchors and tether anchor, if applicable. Tug the child restraint from side to side and forward and back where it is secured to the vehicle. The seat should move less than 2.5 cm (1 in).

If you did not properly anchor the child restraint, the risk of a child being injured in a crash greatly increases.

COMBINING THE SEATBELT AND LOWER ANCHORS FOR ATTACHING CHILD RESTRAINTS

When used in combination, you may attach either the seatbelt or the LATCH lower anchors first, provided a proper installation is achieved. Attach the tether strap afterward, if it is included with the child restraint.

USING TETHER STRAPS

Many forward-facing child restraints include a tether strap which extends from the back of the child restraint and hooks to an anchoring point called the top tether anchor. Tether straps are available as an accessory for many older child restraints.

Contact the manufacturer of your child restraint for information about ordering a tether strap, or to obtain a longer tether strap if the tether strap on your child restraint does not reach the appropriate top tether anchor in the vehicle.

Attach the tether strap only to the appropriate tether anchor. The tether strap may not work properly if attached somewhere other than the correct tether anchor.

If you install a child restraint with rigid LATCH attachments, do not tighten the tether strap enough to lift the child restraint off the vehicle seat cushion when the child is seated in it. Keep the tether strap just snug without lifting the front of the child restraint. Keeping the child restraint just touching the vehicle seat gives the best protection in a severe crash.

Once you have installed the child restraint using either the seatbelt, the lower anchors of the LATCH system, or both, you can attach the top tether strap.

ATTACHING THE FRONT SEAT TETHER STRAP

Regular Cab

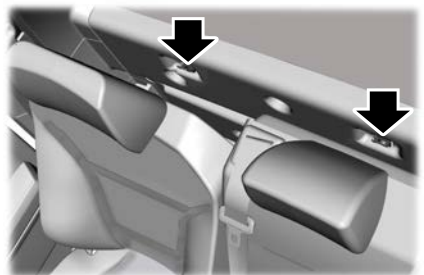

1. Route the child restraint tether strap over the back of the seat and under the head restraint.

Child Safety

Note: For vehicles with adjustable head restraints, route the tether strap under the head restraint and between the head restraint posts. Otherwise, route the tether strap over the top of the seat backrest.

2. Locate the correct anchor for the selected seating position. You may need to pull the seat backrest forward to access the tether anchors. Make sure the seat is locked in the upright position before installing the child restraint.
3. Clip the tether strap to the anchor.
4. Tighten the child restraint tether strap according to the manufacturer's instructions.

If you incorrectly clip the tether strap, the child restraint may not be retained properly in the event of a crash.

If you did not properly anchor the child restraint, the risk of a child being injured in a crash greatly increases.

If your child restraint system has a tether strap, and the child restraint manufacturer recommends its use, we also recommend its use.

ATTACHING THE REAR SEAT TETHER STRAP

Crew Cab and Super Cab

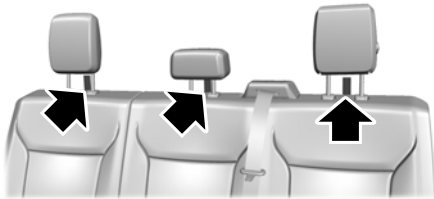

There are three loops of webbing above the back of the rear seat. Use these loops as routing loops and anchor loops for up to three child restraint tether straps.

For example, you can use the center loop as a routing loop for a child restraint in the center rear seat and as an anchoring loop for child restraints installed in the outermost rear seats.

Many tether straps cannot be tightened if the tether strap is hooked to the loop directly behind the child restraint.

To provide a tight tether strap:

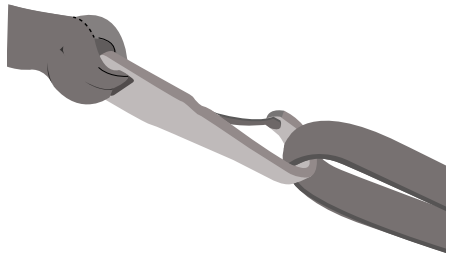

1. Route the vehicle tether loop between the head restraint posts, then route the child restraint tether strap through the loop, forward of the head restraint.
2. Hook the strap to the vehicle tether anchor loop in the adjacent seating position. If using the driver side, pass the strap behind the shoulder belt for the center seat. Put the tether strap through the routing loop. The head restraint support post holds the child restraint tightly, but the head restraint post is not strong enough to hold the child restraint during a crash.
3. Tighten the tether strap according to the child restraint manufacturer's instructions.

Child Safety

If you did not properly anchor the child restraint, the risk of a child being injured in a crash greatly increases.

If your child restraint system has a tether strap, and the child restraint manufacturer recommends its use, we also recommend its use.

BOOSTER SEATS

Use a belt-positioning booster seat for children who have outgrown or no longer properly fit in a child restraint and meet the following criteria.

- Generally children who are less than 1.45 m (57 in) tall.
- Are greater than age four (4) and less than age twelve (12).
- Are between 18 kg (40 lb) and 36 kg (80 lb) and upward to 45 kg (100 lb).

Many state and provincial laws require that children use approved booster seats until they reach age eight, a height of 1.45 m (57 in) tall, or 36 kg (80 lb).

Booster seats should be used until you can answer yes to all of these questions when seated without a booster seat:

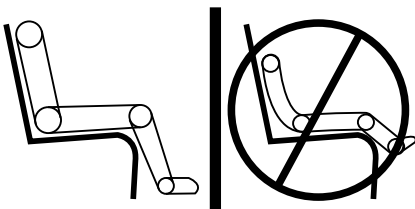

- Can the child sit all the way back against their vehicle seat backrest with knees bent comfortably at the edge of the seat cushion?
- Can the child sit without slouching?
- Does the lap belt rest low across the hips?
- Is the shoulder belt centered on the shoulder and chest?
- Can the child stay seated like this for the whole trip?

Always use booster seats in conjunction with your vehicle lap and shoulder belt.

Types of Booster Seats



- Backless booster seats
If your backless booster seat has a removable shield, remove the shield.

If a vehicle seating position has a low seat backrest or no head restraint, a backless booster seat may place your child's head, as measured at the tops of the ears, above the top of the seat. In this case, move the backless booster to another seating position with a higher seat backrest or head restraint and lap and shoulder belts, or consider using a high-back booster seat.

Child Safety



If, with a backless booster seat, you cannot find a seating position that adequately supports your child's head, a high-back booster seat would be a better choice.

Children and booster seats vary in size and shape. Choose a booster that keeps the lap belt low and snug across the hips, never up across the stomach, and lets you adjust the shoulder belt to cross the chest and rest snugly near the center of the shoulder.

The following drawings compare the ideal fit to a shoulder belt uncomfortably close to the neck and a shoulder belt that could slip off the shoulder. The drawings also show how the lap belt should be low and snug across the child's hips.

- High-back booster seats



Child Safety

If the booster seat slides on the vehicle seat upon which it is being used, placing a rubberized mesh sold as shelf or carpet liner under the booster seat may improve this condition. Do not use any item thicker than this under the booster seat. Check with the booster seat manufacturer's instructions.

CHILD SAFETY LOCKS - CREW CAB/SUPERCAB



WARNING: You cannot open the rear doors from inside if you have put the child safety locks on.



A child safety lock is on the rear edge of each rear door. You must switch the child safety lock separately on each door.

Left-Hand Side

Turn the key clockwise to switch the child lock on and counterclockwise to switch it off.

Right-Hand Side

Turn the key counterclockwise to switch the child lock on and clockwise to switch it off.

Note: To make sure the child safety lock is on, pull the inside door handle twice to verify the door does not open.

Note: To open the rear doors from inside the vehicle when the child lock is engaged, roll down the rear window and use the outside door handle. Or have someone outside the vehicle open the door.

Seatbelts

SEATBELT PRECAUTIONS



WARNING: Always drive and ride with your seatback upright and the lap belt snug and low across the hips.



WARNING: Children must always be properly restrained.



WARNING: Do not allow a passenger to hold a child on their lap when your vehicle is moving. Failure to follow this instruction could result in personal injury or death in the event of a sudden stop or crash.



WARNING: All occupants of your vehicle, including the driver, should always properly wear their seatbelts, even when an airbag supplemental restraint system is provided. Failure to properly wear your seatbelt could seriously increase the risk of injury or death.



WARNING: It is extremely dangerous to ride in a cargo area, inside or outside of a vehicle. In a crash, people riding in these areas are more likely to be seriously injured or killed. Do not allow people to ride in any area of your vehicle that is not equipped with seats and seatbelts. Make sure everyone in your vehicle is in a seat and properly using a seatbelt. Failure to follow this warning could result in serious personal injury or death.



WARNING: In a rollover crash, an unbelted person is significantly more likely to die than a person wearing a seatbelt.



WARNING: Each seating position in your vehicle has a specific seatbelt assembly made up of one buckle and one tongue designed to be used as a pair. Use the shoulder belt on the outside shoulder only. Never wear the shoulder belt under the arm. Never use a single seatbelt for more than one person.



WARNING: Even with advanced restraints systems, properly restrain children 12 and under in a rear seating position. Failure to follow this could seriously increase the risk of injury or death.



WARNING: Seatbelts and seats may be hot in a vehicle that is in the sunshine. The hot seatbelts or seats may burn a small child. Check seat covers and buckles before you place a child anywhere near them.



WARNING: If your vehicle is involved in a crash, have the seatbelts and associated components inspected as soon as possible. Failure to follow this instruction could result in personal injury or death.

All seating positions in this vehicle have seatbelts. All occupants of the vehicle should properly wear their seatbelts, even when an airbag supplemental restraint system is provided.

The seatbelt system consists of:

- Lap and shoulder seatbelts.
- A shoulder seatbelt with automatic locking mode, except driver seatbelt.
- Height adjusters at the front outermost seating positions.
- Seatbelt pretensioners at the front outermost and rear outermost seating positions.

Seatbelts



A seatbelt warning light and chime.



Crash sensors and monitoring system with readiness indicator.

The seatbelt pretensioners are designed to tighten the seatbelts when activated. In frontal and near-frontal crashes, the seatbelt pretensioners may be activated alone or, if the crash is of sufficient severity, together with the front airbags. In side crashes and rollovers, the pretensioners will be activated when the Safety Canopy is activated.

FASTENING AND UNFASTENING THE SEATBELTS



WARNING: Always drive and ride with your seatback upright and the lap belt snug and low across the hips.

All seatbelts in your vehicle are a three-point combination lap and shoulder seatbelt.

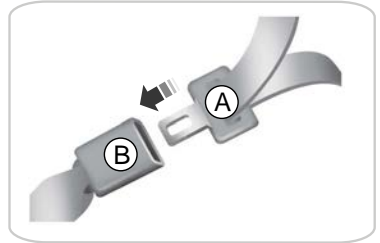

A Seatbelt tongue.

B Seatbelt buckle.

1. Pull the seatbelt out steadily.

Note: *It may lock if you pull it sharply or if the vehicle is on a slope.*

2. Insert the tongue into the buckle.
3. Pull the seatbelt tight to remove any slack.

Unfastening the Seatbelts

1. Press the red button on the buckle to release the seatbelt.
2. Hold the seatbelt tongue and let it retract completely and smoothly to its stowed position.

Using the Seatbelt With Cinch Tongue

This applies to the front center seating position of Super Cab and Crew Cab.

Seatbelts

The cinch tongue slides up and down the seatbelt webbing when you stow the seatbelt or when you put the seatbelts on. When you buckle the seatbelt, the cinch tongue allows you to shorten the lap portion, but pinches the webbing to keep the lap portion from getting longer. The cinch tongue is designed to slip during a crash, so wear the shoulder belt properly and do not allow any slack in either the lap or shoulder portions.

While you are fastened in the seatbelt, the seatbelt with a cinch tongue adjusts to your movement. However, if you brake hard, turn hard, or if your vehicle receives an impact of 8 km/h (5 mph) or more, the seatbelt locks and helps reduce your forward movement.

SENSITIVE LOCKING MODE

WHAT IS SENSITIVE LOCKING MODE

Sensitive locking mode is a seatbelt retractor feature that allows shoulder belt length adjustment according to your movements and locking in response to vehicle movement.

HOW DOES SENSITIVE LOCKING MODE WORK

If the driver suddenly brakes, turns a corner sharply, or the vehicle receives an impact of about 8 km/h (5 mph) or more, the seatbelts lock to help reduce forward movement of the driver and passengers.

In addition, the seatbelt retractor locks if you pull the seatbelt webbing out too quickly. If the retractor locks, slowly lower the height adjuster to allow the seatbelt to retract.

If the retractor does not unlock, pull the seatbelt out slowly then feed a small length of webbing back toward the stowed position.

AUTOMATIC LOCKING MODE

WHAT IS AUTOMATIC LOCKING MODE

This feature keeps the seatbelts pre-locked. The belt still retracts to remove any slack in the shoulder belt.

WHEN TO USE AUTOMATIC LOCKING MODE

Use this mode any time you install a child restraint in a front or rear seating position. Properly restrain children 12 years old and under in a rear seat whenever possible. See **Child Safety** (page 34).

Note: *Automatic locking mode is not available on the driver seatbelt.*

Note: *Vehicles with optional front seat center may not have this function.*

ENGAGING AUTOMATIC LOCKING MODE



1. Fasten the combination lap and shoulder belt.

Seatbelts

2. Grasp the shoulder portion and pull downward until you pull the entire belt out.
3. Allow the belt to retract. As the belt retracts, you will hear a clicking sound. This indicates the seatbelt is now in the automatic locking mode.

DISENGAGING AUTOMATIC LOCKING MODE

Unbuckle the combination lap and shoulder belt and allow it to retract completely to disengage the automatic locking mode and activate the vehicle sensitive locking mode.

ADJUSTING THE SEATBELTS DURING PREGNANCY



WARNING: Always ride and drive with your seatback upright and properly fasten your seatbelt. Fit the lap portion of the seatbelt snugly and low across the hips. Position the shoulder portion of the seatbelt across your chest. Pregnant women must follow this practice. See the following figure.

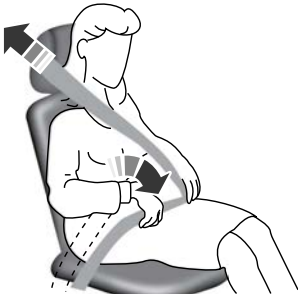

Pregnant women should always wear their seatbelt. Position the lap belt portion of a combination lap and shoulder belt low across the hips below the belly and worn as tight as comfort allows. Position the shoulder belt to cross the middle of the shoulder and the center of the chest.

ADJUSTING THE SEATBELT HEIGHT



WARNING: Position the seatbelt height adjuster so that the seatbelt rests across the middle of your shoulder. Failure to adjust the seatbelt correctly could reduce its effectiveness and increase the risk of injury in a crash.

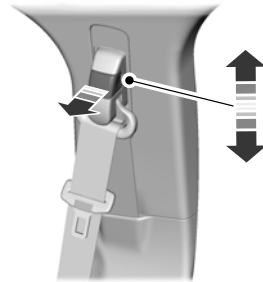

1. Pull the button and slide the height adjuster up or down.
2. Release the button and pull down on the height adjuster to make sure it is locked in place.

Seatbelts

ADJUSTING THE SEATBELT LENGTH



1. Pull some seatbelt webbing out of the shoulder belt retractor.
2. While holding the webbing below the tongue, grasp the metal tip of the tongue so that it is parallel to the webbing and slide the tongue up.

3. Provide enough lap belt length so that the tongue can reach the buckle.

SEATBELT REMINDER

HOW DOES THE SEATBELT REMINDER WORK

This feature supplements the seatbelt warning function. It provides an audible or visual alert when you or an occupant unfastens a seatbelt.

The alert remains on until:

- You open and close a door.
- You fasten the seatbelt for any seat that is occupied.
- You switch the vehicle off and then on.

If	Then
You switch your vehicle on and do not fasten one of the front occupant seatbelts...	The seatbelt reminder activates.
You do not fasten your seatbelt before your vehicle reaches at least 9 km/h (6 mph) ...	The seatbelt reminder activates, the seatbelt warning light illuminates and a warning tone sounds until you fasten your seatbelt.
Rear seats becomes occupied...	The seatbelt reminder becomes active when a rear seat passenger fastens a seatbelt.

This feature also informs the driver that an occupant unfastened their seatbelt.

Seatbelts



- When the ignition is on, a warning informs the driver about the status of each seat, following each seat buckle or unbuckle. You can acknowledge this, or the system will time out after 60 seconds.
- If a seatbelt is unfastened, a second warning informs the driver about which seatbelt was unfastened. A warning remains until all occupants fasten their seatbelt.

SEATBELT REMINDER INDICATORS

A warning lamp illuminates if the ignition is on, a front seat is occupied and the seatbelt has not been fastened.



The warning lamp illuminates until you fasten your seatbelt.

SEATBELT REMINDER AUDIBLE WARNINGS

A warning tone sounds and the warning lamp illuminates if you are not wearing your seatbelt when your vehicle exceeds a relatively low speed.

The warning tone sounds for a short period of time or until you fasten your seatbelt.

SWITCHING THE SEATBELT REMINDER ON AND OFF



WARNING: While the system allows you to deactivate it, this system is designed to improve your chances of being safely belted and surviving an accident. We recommend you leave the system activated for yourself and others who may use the vehicle.

Note: *The driver and front passenger warnings switch off independently. When you perform this procedure for one seating position, do not buckle the other position as this cancels the process.*

Read Steps 1 - 4 before proceeding with the programming procedure.

Make sure that:

- You set the parking brake.
 - The transmission is in park (P).
 - The ignition is off.
 - You close all vehicle doors.
 - You unfasten the driver and front passenger seatbelts.
1. Start the engine.
 2. Wait for a short period of time until the seatbelt warning tone switches off. After Step 2, wait an additional five seconds before proceeding with Step 3. Once you start Step 3, complete the procedure within 30 seconds.
 3. For the seating position you are switching off, fasten then unfasten the seatbelt four times at a moderate speed, ending in the unfastened state. After Step 3, the seatbelt warning light switches on and off with each fasten.
 4. The seatbelt warning light flashes for confirmation.

This switches the feature off for that seating position if it is currently on.

Seatbelts

This switches the feature on for that seating position if it is currently off.

CHECKING THE SEATBELTS

Check the seatbelts and child restraints periodically to make sure they work properly and are not damaged. Make sure there are no nicks, tears or cuts. Replace if necessary.

Check the following seatbelt assemblies after a crash.

- Retractors.
- Buckles.
- Front seatbelt buckle assemblies.
- Shoulder belt height adjusters.
- Shoulder belt guide on seat backrest.
- Child restraint LATCH and tether anchors.
- Attaching hardware.

Read the child restraint manufacturer's instructions for additional inspection and maintenance information specific to the child restraint.

We recommend that all seatbelt assemblies in use in vehicles involved in a crash be replaced. However, if the crash was minor and an authorized dealer finds that the belts do not show damage and continue to operate properly, they do not need to be replaced. Seatbelt assemblies not in use during a crash should also be checked and replaced if either damage or improper operation is noted.

Properly care for seatbelts. See **Cleaning Seatbelts** (page 494).

SEATBELT EXTENSIONS



WARNING: Persons who fit into the vehicle's seatbelt should not use an extension. Unnecessary use could result in serious personal injury in the event of a crash.



WARNING: Only use extensions provided free of charge by our dealers. The dealer will provide an extension designed specifically for this vehicle, model year and seating position. The use of an extension intended for another vehicle, model year or seating position may not offer you the full protection of your vehicle's seatbelt restraint system.



WARNING: Never use seatbelt extensions to install child restraints.



WARNING: Do not use extensions to change the way the seatbelt fits across the torso, over the lap or to make the seatbelt buckle easier to reach.

If, because of body size or driving position, it is not possible to properly fasten the seatbelt over your lap and shoulder, an extension that is compatible with the seatbelts is available free of charge from our dealers. Only use our seatbelt extensions made by the original equipment seatbelt manufacturer with our seatbelts. Ask your authorized dealer if your extension is compatible with your vehicle restraint system.

Airbags

HOW DO THE FRONT AIRBAGS WORK

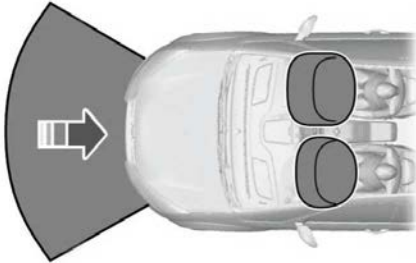

The driver and front passenger airbags deploy during significant frontal and near frontal crashes.

The driver and passenger front airbag system consists of:

- Driver and passenger airbag modules.
- Crash sensors and monitoring system with a readiness indicator. See **Crash Sensors and Airbag Indicator** (page 63).

The airbags are a supplemental restraint system and are designed to work with the seatbelts to help protect the driver and right front passenger from certain upper body injuries. Airbags do not inflate slowly. There is a risk of injury from a deploying airbag.

Note: *You will hear a loud bang and see a cloud of harmless powdery residue if an airbag deploys. This is normal.*

The airbags inflate and deflate rapidly upon activation. After airbag deployment, it is normal to notice a smoke-like, powdery residue or smell the burnt propellant. This may consist of cornstarch, talcum powder, to lubricate the bag, or sodium compounds

(for example, baking soda) that result from the combustion process that inflates the airbag. Small amounts of sodium hydroxide may be present which may irritate the skin and eyes, but none of the residue is toxic.

Contact with a deploying airbag may cause abrasions or swelling. Temporary hearing loss is also a possibility as a result of the noise associated with a deploying airbag.

Because airbags must inflate rapidly and with considerable force, there is the risk of death or serious injuries such as fractures, facial and eye injuries or internal injuries, particularly to occupants who are not properly restrained or are otherwise out of position at the time of airbag deployment. Thus, it is extremely important that occupants be properly restrained as far away from the airbag module as possible while maintaining vehicle control.

The airbag does not require routine maintenance.

HOW DO THE SIDE AIRBAGS WORK



WARNING: Do not place objects or mount equipment on or near the airbag cover, on the side of the front or rear seatbacks, or in areas that may come into contact with a deploying airbag. Failure to follow these instructions may increase the risk of personal injury in the event of a crash.



WARNING: Accessory seat covers not released by Ford Motor Company could prevent the deployment of the airbags and increase the risk of injuries in a crash.

Airbags



WARNING: Do not lean your head on the door. The side airbag could injure you as it deploys from the side of the seatback.

The side airbags are on the outermost side of the seat backrests of the front seats. In certain sideways crashes or rollovers, the airbags will be inflated. The airbag was designed to inflate between the door panel and occupant to further enhance the protection provided to occupants in side impact crashes.



The system consists of the following:

- A label or embossed side panel indicating that side airbags are fitted to your vehicle.
- Side airbags inside the driver and front passenger seat backrests.
- Crash sensors and monitoring system with readiness indicator. See **Crash Sensors and Airbag Indicator** (page 63).

HOW DOES THE SAFETY CANOPY™ WORK



WARNING: Do not place objects or mount equipment on or near the headliner at the siderail that may come into contact with a deploying curtain airbag. Failure to follow these instructions may increase the risk of personal injury in the event of a crash.



WARNING: Do not lean your head on the door. The curtain airbag could injure you as it deploys from the headliner.



WARNING: To reduce risk of injury, do not obstruct or place objects in the deployment path of the airbag.

The Safety Canopy deploys during significant side crashes or when a certain likelihood of a rollover event is detected by the rollover sensor. The Safety Canopy is mounted to the roof side-rail sheet metal, behind the headliner, above each row of seats. In certain sideways crashes or rollover events, the Safety Canopy will be activated, regardless of which seats are occupied. The Safety Canopy inflates between the side window area and occupants to further enhance protection provided in side impact crashes and rollover events.

Airbags

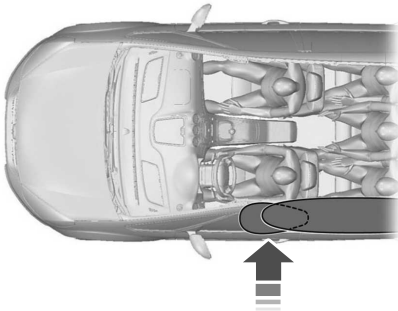

The system consists of the following:

- Safety Canopy curtain airbags above the trim panels over the front and rear side windows identified by a label or wording on the headliner or roof-pillar trim.
- A flexible headliner which opens above the side doors to allow air curtain deployment



• Crash sensors and monitoring system with a readiness indicator. See **Crash Sensors and Airbag Indicator** (page 63).

Properly restrain children 12 years old and under in the rear seats. The Safety Canopy will not interfere with children restrained using a properly installed child or booster seat because it is designed to inflate downward from the headliner above the doors along the side window opening.

AIRBAG PRECAUTIONS



WARNING: Airbags do not inflate slowly or gently, and the risk of injury from a deploying airbag is the greatest close to the trim covering the airbag module.



WARNING: All occupants of your vehicle, including the driver, should always properly wear their seatbelts, even when an airbag supplemental restraint system is provided. Failure to properly wear your seatbelt could seriously increase the risk of injury or death.



WARNING: Properly secure children 12 years old and under in a rear seating position whenever possible. If you are unable to properly secure all children in a rear seating position, properly secure the largest child on the front seat. If you must use a forward facing child restraint on the front seat, move the seat as far back as possible. Failure to follow these instructions could result in personal injury or death.



WARNING: Do not place your arms on the airbag cover or through the steering wheel. Failure to follow this instruction could result in personal injury.



WARNING: Keep the areas in front of the airbags free from obstruction. Do not affix anything to or over the airbag covers. Objects could become projectiles during airbag deployment. Failure to follow this instruction could result in personal injury or death.



WARNING: To reduce risk of injury, do not obstruct or place objects in the deployment path of the airbag.



WARNING: Do not place a rearward facing child restraint in front of an active airbag. Failure to follow this instruction could result in personal injury or death.

Airbags

WARNING: Do not attempt to service, repair, or modify the supplementary restraint system or associated components. Failure to follow this instruction could result in personal injury or death.

WARNING: Several airbag system components get hot after inflation. To reduce the risk of injury, do not touch them after inflation.

WARNING: If a supplementary restraint system component has deployed, it will not function again. Have the system and associated components inspected as soon as possible. Failure to follow this instruction could result in personal injury or death.

WARNING: The front passenger airbag is not designed to offer protection to an occupant in the center seating position.

WARNING: Your vehicle may have an airbag deactivation switch. Before driving, always look at the switch to make sure it is in the appropriate position. Failure to put the switch in the proper position can increase the risk of serious injury or death in a crash.



SWITCHING THE PASSENGER AIRBAG ON AND OFF

WARNING: Even with advanced restraints systems, properly restrain children 12 and under in a rear seating position. Failure to follow this could seriously increase the risk of injury or death.

The front passenger airbag on and off switch has indicators that illuminate, indicating that the front passenger frontal airbag is either on or off. The indicators are near the center of the instrument panel.

Note: *The indicators illuminate for a short period of time when you switch the ignition on to confirm it is functional.*

Switch Position	Passenger Airbag Status Indicator	Passenger Airbag
Off	OFF: Illuminated	Disabled
	ON: Not Illuminated	
On	OFF: Not Illuminated	Enabled
	ON: Illuminated	

Airbags

Switching the Passenger Airbag Off

WARNING: If the light does not illuminate when the passenger airbag switch is off and you switch the ignition on, have the passenger airbag switch serviced immediately by a qualified technician.

WARNING: To avoid switching on the airbag, always remove the ignition key with the switch in the off position.

WARNING: If your vehicle has rear seats, always transport children who are 12 and younger in the rear seat. Always use seatbelts and child restraints properly. Do not place a child in a rear facing infant seat in the front seat unless your vehicle is equipped with an airbag on and off switch and the passenger airbag is turned off. This is because the back of the infant seat is too close to the inflating airbag and the risk of a fatal injury to the infant when the airbag inflates is substantial.

The passenger airbag on and off switch is in the glovebox.



1. Insert the ignition key, turn the switch to OFF and hold in OFF while removing the key.
2. When you switch the ignition on, the passenger airbag off light illuminates briefly, momentarily shuts off and then switches back on. This indicates that the passenger airbag is deactivated.

Switching the Passenger Airbag On

WARNING: The seatbelts for the driver and right front passenger seating positions are specifically designed to operate together with the airbags in certain types of crashes. When you switch off your airbag, you not only lose the protection of the airbag, you also may reduce the effectiveness of your seatbelt system. If the passenger does not meet the requirements stated in the National Highway Traffic Safety Administration or Transport Canada deactivation criteria, switching off the airbag can increase the risk of serious injury or death in a crash.

WARNING: If your vehicle has rear seats, always transport children who are 12 and younger in the rear seat. Always use seatbelts and child restraints properly. Do not place a child in a rear facing infant seat in the front seat unless your vehicle is equipped with an airbag on and off switch and the passenger airbag is turned off. This is because the back of the infant seat is too close to the inflating airbag and the risk of a fatal injury to the infant when the airbag inflates is substantial.

Airbags



WARNING: If the passenger airbag off light is illuminated when the passenger airbag switch is on and the ignition is on, have the passenger airbag switch serviced immediately by a qualified technician.

The passenger airbag remains off until you switch it back on.



1. Insert the ignition key and turn the switch to ON.
2. The passenger airbag off light briefly illuminates when you switch the ignition on. This indicates that the passenger airbag is operational.

The passenger side airbag should always be on, and the passenger airbag off light should not be illuminated, unless the passenger is a person who meets the requirements stated either in Category 1, 2 or 3 of the National Highway Traffic Safety Administration or Transport Canada deactivation criteria which follows.

The vast majority of drivers and passengers are much safer with an airbag than without. To do their job and reduce the risk of life threatening injuries, airbags must open with great force, and this force can pose a potentially deadly risk in some situations, particularly when a front seat occupant is not properly buckled up. The most effective way to reduce the risk of unnecessary airbag injuries without reducing the overall safety of the vehicle is to make sure all occupants are properly restrained in the vehicle, especially in the front seat. This provides the protection of seatbelts and permits the airbags to provide the additional protection they were designed to provide. If you choose to deactivate your airbag, you are losing the very significant risk reducing benefits of the airbag and you are also reducing the effectiveness of the seatbelts. Seatbelts in modern vehicles are designed to work as a safety system with the airbags.

National Highway Traffic Safety Administration Deactivation Criteria-Excluding Canada



WARNING: This vehicle has special energy management seatbelts for the driver and right front passenger. These particular seatbelts are specifically designed to work with airbags to help reduce the risk of injury in a crash. The energy management seatbelt gives or releases additional seatbelt webbing in some accidents to reduce the concentration of force on an occupant's chest and to reduce the risk of certain bone fractures and injuries to underlying organs. In a crash, if the airbag is off, this energy management seatbelt might permit the passenger wearing the seatbelt to move forward enough to have a serious or fatal injury. The more

Airbags

severe the crash, and the heavier the occupant, the greater the risk. Make sure the airbag is on for any passenger who does not qualify under the National Highway Traffic Safety Administration deactivation criteria.

1. **Infant.** An infant, less than 1 year old, must ride in the front seat because:

- The vehicle has no rear seat.
- The vehicle has a rear seat too small to accommodate a rear-facing infant seat.
- The infant has a medical condition which, according to the infant's physician, makes it necessary for the infant to ride in the front so that the driver can constantly monitor the child's condition.

2. **Children age 1 to 12.** Children age 1 to 12 must ride in the front seat because:

- The vehicle has no rear seat.
- Although children ages 1 to 12 ride in the rear seat(s) whenever possible, children ages 1 to 12 sometimes must ride in the front because no space is available in the rear seat(s) of your vehicle.
- The child has a medical condition which, according to the child's physician, makes it necessary for the child to ride in the front seat so that the driver can constantly monitor the child's condition.

3. Medical condition. A passenger has a medical condition which, according to his or her physician:

- Causes the passenger airbag to pose a special risk for the passenger.
- Makes the potential harm from the passenger airbag in a crash greater than the potential harm from turning off the airbag and allowing the passenger, even if belted, to hit the dashboard or windshield in a crash.

Transport Canada Deactivation Criteria-Canada Only



WARNING: This vehicle has special energy management seatbelts for the driver and right front passenger. These particular seatbelts are specifically designed to work with airbags to help reduce the risk of injury in a crash. The energy management seatbelt gives or releases additional seatbelt webbing in some accidents to reduce the concentration of force on an occupant's chest and to reduce the risk of certain bone fractures and injuries to underlying organs. In a crash, if the airbag is off, this energy management seatbelt might permit the passenger wearing the seatbelt to move forward enough to have a serious or fatal injury. The more severe the crash, and the heavier the occupant, the greater the risk. Make sure the airbag is on for any passenger who does not qualify under the Transport Canada deactivation criteria.

1. **Infant:** An infant, less than 1 year old, must ride in the front seat because:

Airbags

- The vehicle has no rear seat.
- The rear seat in my vehicle cannot accommodate a rear-facing infant seat.
- The infant has a medical condition which, according to the infant's physician, makes it necessary for the infant to ride in the front seat so that the driver can monitor the infant's condition.

2. **Children age 12 or under:** Children age 12 or under must ride in the front seat because:

- The vehicle has no rear seat.
- Although children age 12 and under ride in the rear seat whenever possible, children age 12 and under have no option but to sometimes ride in the front seat because rear seat space is insufficient.
- The child has a medical condition that, according to the child's physician, makes it necessary for the child to ride in the front seat so that the driver can monitor the child's condition.

3. **Medical condition:** A passenger has a medical condition that, according to his or her physician:

- Poses a special risk for the passenger if the airbag deploys.
- Makes the potential harm from the passenger airbag deployment greater than the potential harm from turning off the airbag and experiencing a crash without the protection offered by the airbag.

PROPERLY ADJUSTING THE DRIVER AND FRONT PASSENGER SEATS



WARNING: National Highway Traffic Safety Administration (NHTSA) recommends a minimum distance of at least 25 cm (10 in) between an occupant's chest and the driver airbag module.

To properly position yourself away from the airbag:

- Move your seat to the rear as far as you can while still reaching the pedals comfortably.
- Recline the seat slightly one or two degrees from the upright position.

After all occupants have adjusted their seats and put on seatbelts, it is very important that they continue to sit properly. Properly seated occupants sit upright, lean against the seat backrest, and center themselves on the seat cushion, with their feet comfortably extended on the floor. Sitting improperly can increase the chance of injury in a crash event. For example, if an occupant slouches, lies down, turns sideways, sits forward, leans forward or sideways, or puts one or both feet up, the chance of injury during a crash greatly increases.

CHILDREN AND AIRBAGS



WARNING: Do not place a rearward facing child restraint in front of an active airbag. Failure to follow this instruction could result in personal injury or death.

Airbags



Children must always be properly restrained. Accident statistics suggest that children are safer when properly restrained in the rear seating positions than in the front seating position. Failure to follow these instructions may increase the risk of injury in a crash.

If two adults and a child occupy a vehicle without rear seats, properly restrain the child in the center front seat unless doing so would interfere with driving your vehicle. This provides lap and shoulder belt protection for all occupants, and airbag protection for the adults. A child or infant properly restrained in the center front seat should have a reduced risk to serious injury from the airbags.

CRASH SENSORS AND AIRBAG INDICATOR



WARNING: Modifying or adding equipment to the front of your vehicle could affect the performance of the airbag system, increasing the risk of injury. This includes the hood, bumper system, frame, front body structure, tow hooks, hood pins, push bar and snowplows.

Your vehicle has a collection of crash and occupant sensors. These sensors provide information to the restraints control module which activates the following:

- Seatbelt pretensioners.
- Adaptive steering column.
- Driver airbag.
- Passenger airbag.
- Seat mounted side airbags.
- Safety Canopy.

Based on the type of crash, the restraints control module deploys the appropriate safety devices.

The restraints control module also monitors the readiness of the above safety devices plus the crash and occupant sensors. The readiness of the safety system is indicated by a warning indicator light in the instrument cluster or by a backup tone if the warning light is not working. The airbag does not require routine maintenance.

A difficulty with the system is indicated by one or more of the following:



The readiness light will not illuminate immediately after you switch the ignition on.

- The readiness light either flashes or stays on.
- You hear a series of five tones. The tone pattern repeats periodically until the problem, the light or both are repaired.

If any of these things happen, even intermittently, have the supplemental restraint system serviced immediately. Unless serviced, the system may not function properly in the event of a crash.

Airbags

The fact that the seatbelt pretensioners or front airbags did not activate for both front seat occupants in a crash does not mean that something is wrong with the system. Rather, it means the restraints control module determined the accident conditions (crash severity, seatbelt usage) were not appropriate to activate these safety devices.

- The front airbags activate only in frontal and near-frontal crashes. Front airbags may activate in rollovers, side impacts or rear impacts if the crash causes sufficient frontal deceleration.
- The adaptive steering column activates only in frontal and near-frontal crashes. It may activate in rollovers, side impacts or rear impacts if the crash causes sufficient frontal deceleration.
- The seatbelt pretensioners activate in frontal, near-frontal and side crashes, and in rollovers.
- The side airbags inflate in certain side impact crashes or rollover events. Side airbags may activate in other types of crashes if the vehicle experiences sufficient sideways motion or deformation.
- The Safety Canopy inflates in certain side impact crashes or rollover events. The Safety Canopy may activate in other types of crashes if the vehicle experiences sufficient sideways motion or deformation, or a certain likelihood of rollover.

DISPOSING OF AIRBAGS

Contact your authorized dealer as soon as possible. Airbags must be disposed of by qualified personnel.

911 Assist (If Equipped)

WHAT IS 911 ASSIST

911 Assist is a SYNC system feature that can call for help.

For more information, visit www.owner.ford.com.

HOW DOES 911 ASSIST WORK

If a crash deploys an airbag, excluding knee airbags and rear inflatable seatbelts, or activates the fuel pump shut-off, your vehicle may be able to contact emergency services by dialing 911 through a paired and connected **Bluetooth**® enabled phone.

Not all crashes deploy an airbag or activate the fuel pump shut-off. If a connected cell phone sustains damage or loses its connection to SYNC during a crash, SYNC searches for and tries to connect to a previously paired cell phone. SYNC then attempts to call the emergency services.

Before making the call:

- SYNC provides about 10 seconds to cancel the call. If you fail to cancel the call, SYNC attempts to dial 911.
- SYNC says the following, or a similar message: SYNC will attempt to call 911, to cancel the call, press Cancel on your screen or press and hold the phone button on your steering wheel.

If you do not cancel the call and SYNC makes a successful call a pre-recorded message plays for the 911 operator. The occupants in your vehicle are able to talk with the operator. Be prepared to provide your name, phone number and location immediately because not all 911 systems are capable of receiving this information electronically.

During an emergency call the system transmits vehicle data to the emergency service.

EMERGENCY CALL REQUIREMENTS



WARNING: Do not wait for 911 Assist to make an emergency call if you can do it yourself. Dial emergency services immediately to avoid delayed response time which could increase the risk of serious injury or death after a crash. If you do not hear 911 Assist within five seconds of the crash, the system or phone may be damaged or non-functional.



WARNING: Always place your phone in a secure location in your vehicle so it does not become a projectile or get damaged in a crash. Failure to do so may cause serious injury to someone or damage the phone which could prevent 911 Assist from working properly.



WARNING: Unless the 911 Assist setting is set on before a crash, the system will not dial for help which could delay response time, potentially increasing the risk of serious injury or death after a crash.

- SYNC is powered and working properly at the time of the incident and throughout feature activation and use.
- The 911 Assist feature must be set on before the incident.
- You must pair and connect a **Bluetooth**® enabled and compatible cell phone to SYNC.
- A connected **Bluetooth**® enabled phone must have the ability to make and maintain an outgoing call at the time of the incident.

911 Assist (If Equipped)

- A connected **Bluetooth**® enabled phone must have adequate network coverage, battery power and signal strength.
- The vehicle must have battery power and be located in the U.S., Canada or in a territory in which 911 is the emergency number.

Note: *If any user sets 911 Assist to on or off, that setting applies for all paired phones. If 911 Assist is off and the phone connected to SYNC, an icon displays on the status bar.*

Note: *Every phone operates differently. While SYNC 911 Assist works with most cellular phones, some may have trouble using this feature.*

EMERGENCY CALL LIMITATIONS

The SYNC 911 Assist feature only operates in the U.S., Canada or in a territory in which 911 is the emergency number. The following are limitations of this feature:

- Your cellular phone or 911 Assist hardware sustains damage in a crash.
- The vehicle's battery or the SYNC system has no power.
- The phone(s) thrown from your vehicle are the ones paired and connected to the system.

911 ASSIST VIDEOS

[911 Assist Video Link](#)

Keys and Remote Controls

REMOTE CONTROL LIMITATIONS



WARNING: Changes or modifications not expressly approved by the party responsible for compliance could void the user's authority to operate the equipment. The term "IC:" before the radio certification number only signifies that Industry Canada technical specifications were met.

This device complies with Part 15 of the FCC Rules and with Industry Canada license-exempt RSS standard(s). Operation is subject to the following two conditions: (1) This device may not cause harmful interference, and (2) This device must accept any interference received, including interference that may cause undesired operation.

Make sure a valid remote control is within 1 m (3 ft) from the front door handles and rear of vehicle.

The system may not function if:

- The remote control remains stationary for about a minute.
- The vehicle battery has no charge.
- The remote control battery has no charge.
- There is interference causing issues with the remote control frequencies.
- The remote control is too close to metal objects or electronic devices, for example keys or a cell phone.

USING THE REMOTE CONTROL



WARNING: Do not leave a key or remote control unattended in the vehicle. Children or pets could operate the power windows, moonroof or other controls. Failure to follow this instruction could result in personal injury or death.

Use your remote control to access various vehicle systems.

Note: *The buttons on your remote may vary depending on the vehicle region or options.*

Unlock



Press the button to unlock all doors. See **Unlocking and Locking the Doors Using the Remote Control** (page 75).

Lock



Press the button to lock all doors. See **Unlocking and Locking the Doors Using the Remote Control** (page 75).

Remote Start (If Equipped)



Press the button twice within three seconds to remote start. See **Using Remote Start** (page 137).

Tailgate (If Equipped)



Press the button twice within three seconds to open the tailgate. See **Opening the Tailgate Using the Remote Control** (page 91).

Keys and Remote Controls

Panic Alarm (if Equipped)



Press the button to sound the panic alarm. See **Sounding the Panic Alarm** (page 69).

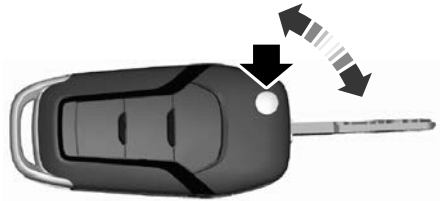

OPENING AND CLOSING THE FLIP KEY

Opening Your Flip Key

Press the round button on the remote control to extend the flip key.

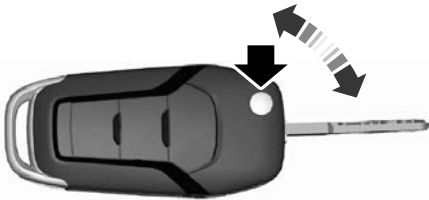

Note: *Inspect the key blade for debris. Periodically clean with a brush.*

Closing Your Flip Key

Press and hold the round button on the remote control to fold the key blade when not in use.

REMOVING THE KEY BLADE - VEHICLES WITH: PUSH BUTTON START



Push the release button on your passive key and pull the key blade out.

Keys and Remote Controls

SOUNDING THE PANIC ALARM



Press the button to sound the panic alarm. Press the button again, or switch the ignition on to turn it off.

Note: *The panic alarm only operates when the ignition is off.*

LOCATING YOUR VEHICLE



Press the lock button twice within three seconds. The turn signal lamps flash.

Note: *We recommend you use this method to locate your vehicle.*

CHANGING THE REMOTE CONTROL BATTERY - VEHICLES WITH: FLIP KEY



WARNING: Keep batteries away from children to prevent ingestion. Failure to follow this instruction could result in personal injury or death. If ingested, immediately seek medical attention.



WARNING: If the battery compartment does not securely close, stop using the remote control and replace it as soon as possible. In the meantime, keep the remote control away from children. Failure to follow this instruction could result in personal injury or death.

Battery Replacement Procedure

The remote control uses one coin-type 3-volt lithium battery CR2032 or equivalent.

Press the button to release the key blade before beginning the procedure.

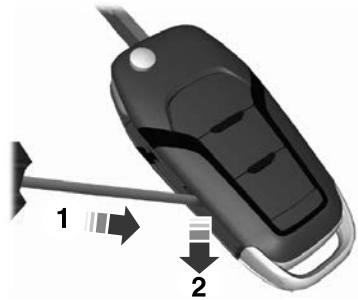

1. Insert a screwdriver, in the position shown and gently push the clip.
2. Press the clip down to release the battery cover.

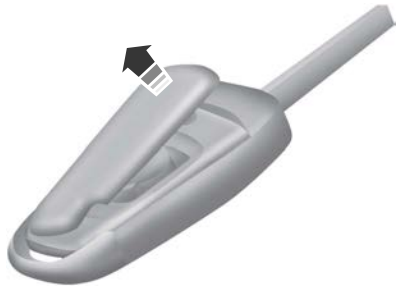

3. Carefully remove the cover.



Keys and Remote Controls

4. Insert a screwdriver as shown to release the battery.



Note: Do not touch the battery contacts or the printed circuit board with the screwdriver.

5. Remove the battery.
6. Install a new battery with the + facing up.
7. Replace the battery cover.



Dispose of old batteries in an environmentally friendly way. Seek advice from your local authority about recycling old batteries.

Note: Do not wipe off any grease on the battery terminals or on the back surface of the circuit board.

Note: Replacing the battery does not erase the programmed key from your vehicle. The remote control should operate normally.

CHANGING THE REMOTE CONTROL BATTERY - VEHICLES WITH: PUSH BUTTON START

WARNING: Keep batteries away from children to prevent ingestion. Failure to follow this instruction could result in personal injury or death. If ingested, immediately seek medical attention.

WARNING: If the battery compartment does not securely close, stop using the remote control and replace it as soon as possible. In the meantime, keep the remote control away from children. Failure to follow this instruction could result in personal injury or death.

The remote control uses one coin-type 3-volt lithium battery CR2450 or equivalent.



Keys and Remote Controls

1. Push the release button and pull the key blade out.

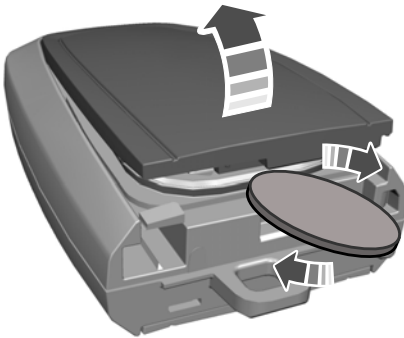
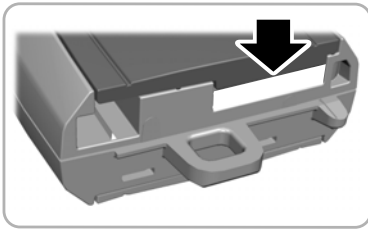

2. Twist a thin coin under the tab hidden behind the key blade head to remove the battery cover.

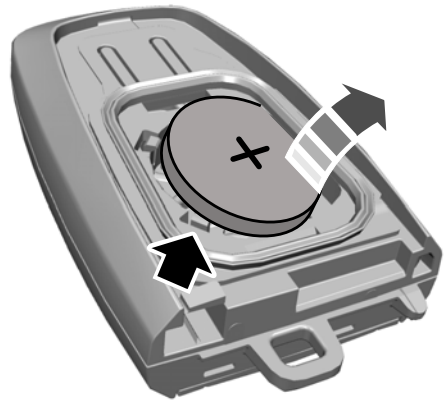

3. Insert a screwdriver, and carefully remove the battery.
4. Install a new battery with the + facing upward.
5. Reinstall the battery housing cover onto the transmitter and install the key blade.



Dispose of old batteries in an environmentally friendly way. Seek advice from your local authority about recycling old batteries.

Note: Do not wipe off any grease on the battery terminals or on the back surface of the circuit board.

Note: Replacing the battery does not erase the programmed key from your vehicle. The remote control should operate normally.

REPLACING A LOST KEY OR REMOTE CONTROL

You can purchase replacement keys or remote controls from an authorized dealer. Authorized dealers can program remote controls for your vehicle.

Keys and Remote Controls



Note: Your vehicle keys came with a security label that provides important key cut information. Keep the label in a safe place for future reference.

PROGRAMMING THE REMOTE CONTROL - VEHICLES WITH: FLIP KEY

General Information

You can program your own remote control to your vehicle. This procedure programs both the engine immobilizer keycode and the remote entry portion of the remote control to your vehicle.

Only use remote controls with an integrated mechanical key.

You must have two previously programmed remote controls and the new unprogrammed remote readily accessible. Contact an authorized dealer to have the spare remote control programmed if the two previously programmed remote controls are not available.

Read and understand the entire procedure before you begin.

Steps for Programming Your Spare Remote Control

1. Insert the first previously programmed key into the ignition.
2. Switch the ignition from off to on. Keep the ignition on for at least three seconds, but no more than 10 seconds.

3. Switch the ignition off and remove the first previously programmed key from the ignition.
4. After three seconds but within 10 seconds of switching the ignition off, insert the second previously programmed key into the ignition.
5. Switch the ignition from off to on. Keep the ignition on for at least three seconds, but no more than 10 seconds.
6. Switch the ignition off and remove the second previously programmed key from the ignition.
7. After three seconds but within 10 seconds of switching the ignition off and removing the previously programmed key, insert the new unprogrammed key into the ignition.
8. Switch the ignition from off to on. Keep the ignition on for at least six seconds until you hear the door locks cycle.
9. Remove the newly programmed key from the ignition.

The key starts the engine if programming is successful. You can operate the keyless remote entry system with the new remote control with integrated key.

If programming is not successful, wait 20 seconds and repeat steps 1 through 8. If you are still unsuccessful, take your vehicle to an authorized dealer.

Note: You can program a maximum of six remote controls to your vehicle.

Keys and Remote Controls

PROGRAMMING THE REMOTE CONTROL - VEHICLES WITH: PUSH BUTTON START

General Information

You must have two previously programmed remote controls inside your vehicle and the new unprogrammed remote controls readily accessible. Contact an authorized dealer to have the spare remote control programmed if two previously programmed remotes are not available. Make sure that your vehicle is off before beginning this procedure. Make sure that you close all the doors before beginning and that they remain closed throughout the procedure. Perform all steps within 30 seconds of starting the sequence. Stop and wait for at least one minute before starting again if you perform any steps out of sequence.

Read and understand the entire procedure before you begin.

Note: You can program a maximum of four remote controls to your vehicle.

Note: If your programmed remote controls are lost or stolen and you do not have an extra coded remote, you need to have your vehicle towed to an authorized dealer. Store an extra programmed remote away from your vehicle in a safe place to help prevent any inconvenience. Contact an authorized dealer to purchase additional spare or replacement remotes.

Steps for Programming Your Spare Remote Control

Note: Your vehicle is equipped with one of the following center consoles.

Programming Backup Location

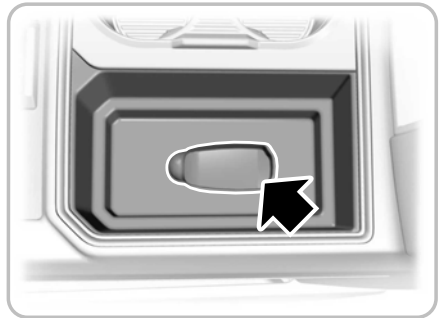
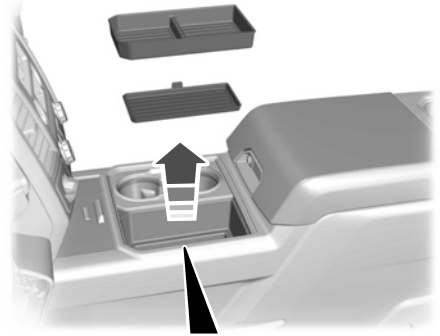

Keys and Remote Controls

1. Place the first programmed remote in the backup slot inside the center console with your foot off the brake pedal, press and release the push button ignition switch.
2. Wait five seconds and then press and release the push button ignition switch again.
3. Remove the remote control.
4. Within 10 seconds, place a second programmed remote control in the backup slot. Press and release the push button ignition switch.
5. Wait five seconds and then press and release the push button ignition switch again. Keep the ignition on for at least three seconds, but no more than 10 seconds.
6. Remove the remote control.
7. Place the unprogrammed remote control in the backup slot and press and release the push button ignition switch.

Programming is now complete. With your foot on the brake pedal, press the push button ignition switch to verify the remote control functions operate and your vehicle starts with the new remote control.

If programming was not successful, wait 10 seconds and repeat Steps 1 through 7. If you are still unsuccessful, take your vehicle to an authorized dealer.

KEYS AND REMOTE CONTROLS AUDIBLE WARNINGS - VEHICLES WITH: PUSH BUTTON START

Key In Reminder

Sounds when the following conditions are met:

- Vehicle is out of park (P).
- You switch the vehicle off.
- You open the driver's door.
- You have left the key inside the vehicle.

KEYS AND REMOTE CONTROLS AUDIBLE WARNINGS - VEHICLES WITH: FLIP KEY

Sounds when you open the driver's door, turn off the vehicle and you have left the key in the ignition.

KEYS AND REMOTE CONTROLS – TROUBLESHOOTING

KEYS AND REMOTE CONTROLS – INFORMATION MESSAGES

Message	Action
Key Battery Low Replace Soon	Replace remote control battery.

Doors and Locks

OPERATING THE DOORS FROM OUTSIDE YOUR VEHICLE

UNLOCKING AND LOCKING THE DOORS USING THE REMOTE CONTROL

You can only use the remote control when your vehicle is stationary.

Unlocking the Doors



Press the button to unlock all doors. One long flash of the turn signal lamps confirms that your vehicle has unlocked.

Locking the Doors



Press the button to lock all doors. One short flash of the turn signal lamps confirms that your vehicle has locked.

UNLOCKING AND LOCKING THE DOORS USING THE KEY BLADE

If there is a power door lock fault you can use the key blade to lock and unlock the doors.

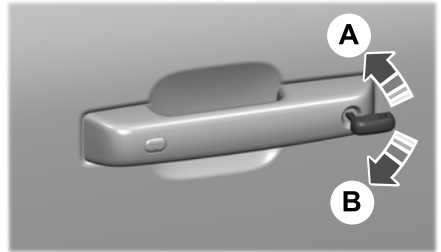

A Lock.

B Unlock.

OPERATING THE DOORS FROM INSIDE YOUR VEHICLE

UNLOCKING AND LOCKING THE DOORS USING THE CENTRAL LOCKING

The power door lock control is on the front doors.



Press the button to unlock all doors.



Press the button to lock all doors.

Note: The central locking only operates if the front doors are fully closed.

OPENING THE DOORS FROM INSIDE YOUR VEHICLE

Pull the interior door handle twice to unlock and open a rear door. The first pull unlocks the door and the second pull opens the door.

Doors and Locks

AUTOUNLOCK

WHAT IS AUTOUNLOCK

Autounlock is a feature that centrally unlocks the vehicle doors when your vehicle comes to a stop and you open the driver door.

AUTOUNLOCK REQUIREMENTS

Autounlock unlocks all the doors after:

1. The vehicle speed exceeds 20 km/h (12 mph).
2. Your vehicle comes to a stop.
3. You open the driver door.

Note: *Autounlock operates for only 10 minutes after the ignition is switched off.*

SWITCHING AUTOUNLOCK ON AND OFF

1. Press **Settings** on the touchscreen.
2. Press **Vehicle Settings**.
3. Press **Locks**.
4. Switch **Autounlock** on or off.

AUTOLOCK

WHAT IS AUTOLOCK

Autolock is a locking feature that centrally locks your vehicle doors when driving.

AUTOLOCK REQUIREMENTS

Autolock locks all the doors after:

1. All doors are closed and the ignition is on.
2. Your vehicle speed exceeds 20 km/h (12 mph).

Autolock repeats if:

1. Your vehicle is stopped.
2. Any door is opened and closed again.
3. Your vehicle speed exceeds 20 km/h (12 mph).

MISLOCK

WHAT IS MISLOCK

Mislock is a locking feature that warns you if your vehicle has not locked.

MISLOCK LIMITATIONS

When you press the lock button once, the turn signals do not flash if:

- Any door or the tailgate is open.
- The hood is open.

If you switch mislock off, the horn does not sound if you press the lock button on the remote control when a door is open.

SWITCHING MISLOCK ON AND OFF

1. Press **Settings** on the touchscreen.
2. Press **Vehicle Settings**.
3. Press **Locks**.
4. Switch **Mislock Chirp** on or off.

DOORS AND LOCKS AUDIBLE WARNINGS

Door Ajar Audible Warning

Sounds when any front door is not fully closed and your vehicle is moving.

Doors and Locks

DOORS AND LOCKS – TROUBLESHOOTING

DOORS AND LOCKS – WARNING LAMPS

Door Ajar Warning Lamp



It illuminates when you switch the ignition on and remains on if any door is open.

DOORS AND LOCKS – INFORMATION MESSAGES

Message	Details
Driver Door Ajar	Displays if a door is open. Fully close the door.
Passenger Door Ajar	
Rear Left Door Ajar	
Rear Right Door Ajar	
Hood Ajar	Displays if a hood is open. Fully close the hood.

Doors and Locks

DOORS AND LOCKS – FREQUENTLY ASKED QUESTIONS

Can accessories such as steps or handles be used with the latch assembly?

- Do not use the door latch assembly to attach any accessory, such as handles or steps, as this can cause damage to your vehicle.

Keyless Entry (If Equipped)

KEYLESS ENTRY LIMITATIONS

Make sure your remote control is within 1 m (3 ft) from the front door handles and the tailgate.

The system could not function if:

- The remote control remains stationary for about a minute.
- The vehicle battery has no charge.
- The remote control battery has no charge.
- There is interference causing issues with the remote control frequencies.
- The remote control is too close to metal objects or electronic devices, for example keys or a cell phone.

KEYLESS ENTRY SETTINGS

Reprogramming the Unlocking Function (If Equipped)

You can enable the two-stage unlocking function allowing you to unlock only the driver door when you touch the unlock sensor.

Press and hold both the lock and unlock buttons on the remote control for four seconds to disable or enable two-stage unlocking.

If you program the unlocking function so that only the driver door unlocks, you can unlock all of the other doors from inside your vehicle using the power door lock control. You can unlock individual doors by pulling the interior door handles on those doors.

Key Detection Alert

Displays a message in the instrument cluster if no valid key is detected, when you exit your vehicle with a key, after the last front door is closed and your keyless vehicle is in run, indicating your vehicle is still on. An audible alert sounds if you have driven the vehicle and reached a speed of 25 km/h (16 mph) and the above mentioned conditions are met.

You can switch the audible alert on or off.

1. From the settings menu, press Vehicle. See **Center Display** (page 558).
2. Switch Key Detection Alert On or Off.

USING KEYLESS ENTRY

Unlocking the Doors



With your passive key within 1 m (3 ft) of your vehicle, touch the unlock sensor on the back of the door handle for a brief period and then pull on the door handle to unlock, being careful not to touch the lock sensor at the same time or pull on the door handle too quickly. The intelligent access system requires a brief delay to authenticate your passive key.

Locking the Doors



Keyless Entry (If Equipped)

With your passive key within 1 m (3 ft) of your vehicle, touch the outer door handle lock sensor for approximately one second to lock, being careful not to touch the unlock sensor on the back of the door handle at the same time. After locking, you can immediately pull on the door handle to confirm locking occurred without inadvertently unlocking.

KEYLESS ENTRY – TROUBLESHOOTING

KEYLESS ENTRY – FREQUENTLY ASKED QUESTIONS

Why does the keyless entry system not function?

If the system does not function it may be limited. See **Keyless Entry Limitations** (page 79). If the system still does not function use the remote control or the key blade to lock and unlock your vehicle.

Why can I not lock my vehicle?

If you electronically lock your vehicle with a rear door or the tailgate open, the system searches for a passive key inside your vehicle after you close the last door. If the system detects a key, all doors unlock indicating that a key is inside. Your vehicle locks if another passive key is within the detection range after you close the last door.

KEYLESS ENTRY VIDEOS

[*Using Intelligent Access with Push-button Start Video Link*](#)

Easy Entry and Exit (If Equipped)

HOW DOES EASY ENTRY AND EXIT WORK

Easy entry and exit moves the driver seat rearward and the steering column up when you switch the ignition off. The driver seat and steering column return to their previous positions when you switch the ignition on.

Note: *Depending on your vehicle, the column may move up and in.*

SWITCHING EASY ENTRY AND EXIT ON AND OFF

1. Press **Settings** on the touchscreen.
2. Press **Vehicle**.
3. Press **Easy Entry/Exit**.

If you press any adjustment or memory button when in easy exit mode, the system cancels the operation.

Tailgate - Vehicles With: Manual Tailgate

TAILGATE PRECAUTIONS



WARNING: It is extremely dangerous to ride in a cargo area, inside or outside of a vehicle. In a crash, people riding in these areas are more likely to be seriously injured or killed. Do not allow people to ride in any area of your vehicle that is not equipped with seats and seatbelts. Make sure everyone in your vehicle is in a seat and properly using a seatbelt. Failure to follow this warning could result in serious personal injury or death.

OPENING THE TAILGATE

OPENING THE TAILGATE FROM OUTSIDE YOUR VEHICLE

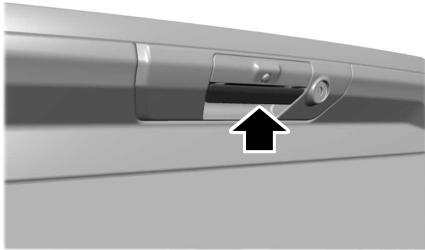

Pull up on the handle to release the tailgate.

Note: You may need to unlock the tailgate first.

REMOVING AND INSTALLING THE TAILGATE



WARNING: Always properly secure cargo to prevent shifting cargo or cargo falling from the vehicle. Failure to do so could result in compromised vehicle stability and serious personal injury to vehicle occupants or others.



WARNING: The tailgate is heavy. Removal of the tailgate requires two adults. Failure to follow this instruction could result in personal injury or property damage.

Note: Before removing the tailgate, make sure the tailgate removal kit with the protective caps is in the glove compartment. If it is not, one can be provided free of charge by your authorized dealer. Failure to install the protective caps results in damage to the electrical system not covered by the vehicle warranty.

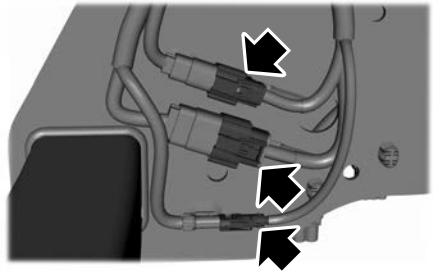

1. Locate and disconnect the frame connections. They are on the left-hand side of the vehicle.

Note: Your vehicle may have up to three frame connections.

Tailgate - Vehicles With: Manual Tailgate

2. Install the protective caps on the in-line connector portion that remains under the pickup box.
3. Partially lower the tailgate. Carefully feed the tailgate harness up through the gap between the pickup box and the bumper and place it out of the way under the pickup box.
4. Lower the tailgate.

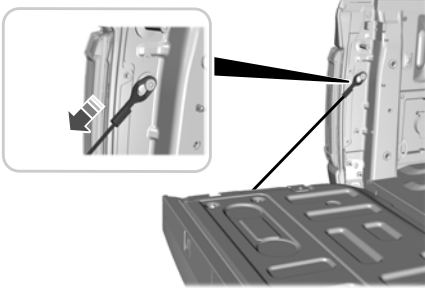

5. Use a screwdriver to gently pry the spring clip on each connector past the head of the support screw. Disconnect the cable.
6. Disconnect the other cable.
7. Lift the tailgate to 45 degrees from the horizontal position.
8. Lift the right-hand side off its hinge.
9. Lift the tailgate to 80 degrees from the horizontal position.
10. Remove the tailgate from the left-hand side hinge by sliding it to the right.
11. Install the tailgate in reverse order.

TAILGATE STEP

ACCESSING THE TAILGATE STEP

1. Lower the tailgate.

2. Push the button in the center of the step molding. The step pops out slightly.

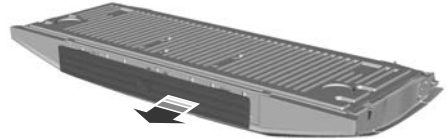
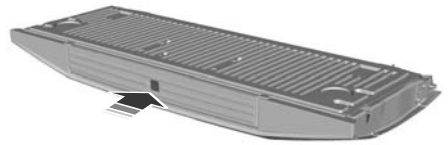

3. Pull the step out fully. Lower the step to its lowest position.

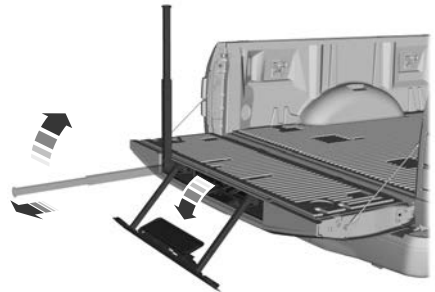

4. Pull the yellow handle stop backward out of the tailgate until it fully extends.
5. To lock the handle in place, rotate the handle up from the horizontal to the vertical position until you hear a click.

Note: Do not tow with the step or grab handle.

Replace the slip resistance tape or grab handle molding if it appears as worn or damaged.

Tailgate - Vehicles With: Manual Tailgate

To reduce the risk of falling:

- Only operate the step when your vehicle is on a level surface.
- Only operate the step in areas with sufficient lighting.
- Make sure you use the grab handle when climbing on the step.
- Do not use the step with bare feet.
- Make sure the step is clean before use.
- Keep the step load below the total maximum load of 159 kg (350 lb).

STOWING THE TAILGATE STEP

1. Press the yellow button on the handle to lower and then press the yellow lever at the bottom of the handle to unlock. Rotate the handle down from the vertical to the horizontal position and push it into the tailgate.
2. Rotate the step up until it is horizontal, then push it back into the tailgate until the step is secure.

Note: *Make sure to close and fully latch the step before moving your vehicle. Do not drive with the step or grab handle open.*

TAILGATE VIDEOS

[Integrated Tailgate Step Video Link](#)

[Remote tailgate release Video Link](#)

Tailgate - Vehicles With: Power Tailgate

TAILGATE PRECAUTIONS



WARNING: It is extremely dangerous to ride in a cargo area, inside or outside of a vehicle. In a crash, people riding in these areas are more likely to be seriously injured or killed. Do not allow people to ride in any area of your vehicle that is not equipped with seats and seatbelts. Make sure everyone in your vehicle is in a seat and properly using a seatbelt. Failure to follow this warning could result in serious personal injury or death.

OPENING THE TAILGATE

OPENING THE TAILGATE FROM INSIDE YOUR VEHICLE

To operate the power tailgate, the vehicle must be in park (P) or reverse (R) and the vehicle speed is less than 4 km/h (2.5 mph).



Press the tailgate release button located near the headlight control.

Note: A tone sounds while the tailgate opens.

Note: The tailgate stops and reverses if it detects an obstruction when opening.

Note: An alert sounds if the electronic tailgate is in manual mode.

Note: A pop-up message appears on the touchscreen if the tailgate is in manual mode asking if you want to change back to power mode.

OPENING THE TAILGATE FROM OUTSIDE YOUR VEHICLE

1. Unlock the vehicle with the remote control or power door unlock control.

Note: If an authorized device is within 1 m (3 ft) of the tailgate, the tailgate unlocks when you press the tailgate release button.

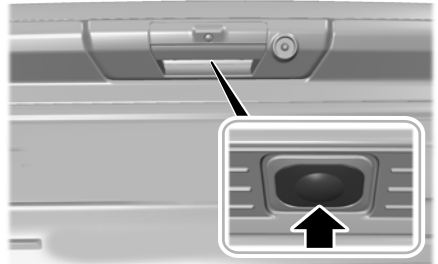

2. Press the button on the middle of the tailgate.

OPENING THE TAILGATE USING THE REMOTE CONTROL



Press the remote control button twice within three seconds.

CLOSING THE TAILGATE

CLOSING THE TAILGATE FROM INSIDE YOUR VEHICLE



Press the tailgate release button located near the headlight control.

Note: The tailgate does not close if the vehicle speed is at or above 4 km/h (2.5 mph).

Tailgate - Vehicles With: Power Tailgate

Note: The tailgate does not close with the tailgate step ajar. A Step Ajar message displays on the instrument cluster.

CLOSING THE TAILGATE FROM OUTSIDE YOUR VEHICLE

You can close the power tailgate by:

- Pressing the tailgate button on your remote control twice within three seconds.
- Pressing the button on the tailgate once.

Note: A tone sounds while the tailgate closes.

Note: The tailgate stops and reverses if it detects an obstruction when closing.

Lift-to-Close

To automatically close the tailgate using lift-to-close, lift the tailgate approximately 10 cm (4 in) and hold it for a few seconds.

Note: If the tailgate position is more than halfway closed, it may not automatically close.

Manual Close

You can manually close the tailgate when you lift the tailgate in a continuous motion.

If you stop the tailgate motion, the lift-to-close feature engages and power closes the tailgate.

Putting the Tailgate in Manual Mode

You can put the tailgate in manual mode through the vehicle settings in your touchscreen.

Note: In manual mode, the tailgate only opens by the tailgate release button on the tailgate and messaging is reduced.

Note: A pop-up message appears on the touchscreen if you press the tailgate button on the instrument panel when the tailgate is in manual mode.

CLOSING THE TAILGATE USING THE REMOTE CONTROL



Press the remote control button twice within three seconds.

REMOVING AND INSTALLING THE TAILGATE



WARNING: Always properly secure cargo to prevent shifting cargo or cargo falling from the vehicle. Failure to do so could result in compromised vehicle stability and serious personal injury to vehicle occupants or others.



WARNING: The tailgate is heavy. Removal of the tailgate requires two adults. Failure to follow this instruction could result in personal injury or property damage.

Note: Before removing the tailgate, make sure the tailgate removal kit with the protective caps is in the glove compartment. If it is not, one can be provided free of charge by your authorized dealer. Failure to install the protective caps results in damage to the electrical system not covered by the vehicle warranty.

Tailgate - Vehicles With: Power Tailgate

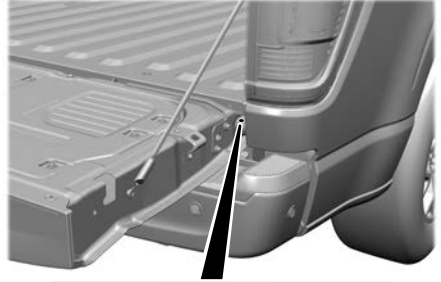
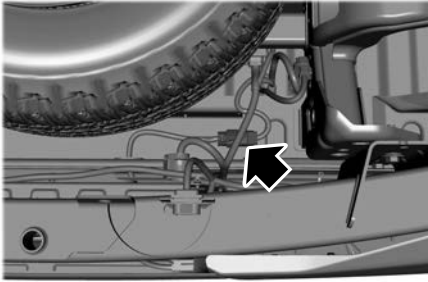

1. Put the tailgate into manual mode by accessing the vehicle settings using the touchscreen.
2. Open the tailgate.
3. Disconnect the power door locks in-line connector located under the pickup box on the right-hand side of the vehicle near the spare tire.
4. Install the protective cap on the in-line connector portion that remains under the pickup box.
5. Partially raise the tailgate. Carefully feed the tailgate harness up through the gap between the pickup box and the bumper and place it out of the way under the pickup box.
6. Fully lower the tailgate.

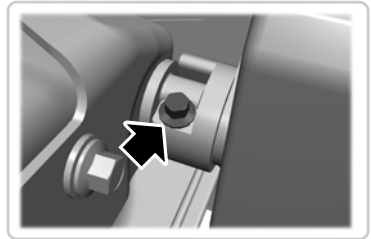

7. Remove the retaining screw.

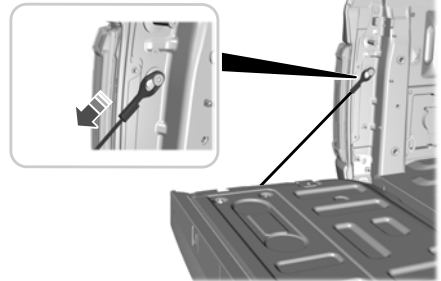

8. Use a screwdriver to gently pry the spring clip on each connector past the head of the support screw. Disconnect the cable.
9. Disconnect the other cable.
10. Lift the tailgate to 45 degrees from the horizontal position.
11. Lift the right-hand side off its hinge.

Tailgate - Vehicles With: Power Tailgate

12. Lift the tailgate to 80 degrees from the horizontal position.
13. Remove the tailgate from the left-hand side hinge by sliding it to the right.
14. Install the tailgate in reverse order.

Note: After reinstalling the tailgate it is important to reinstall the retaining screw to the recommended torque, 15 Nm (11.06 lb.ft). Failure to install the retaining screw can cause the tailgate to detach.

TAILGATE STEP

ACCESSING THE TAILGATE STEP

1. Lower the tailgate.
2. Push the button in the center of the step molding. The step pops out slightly.

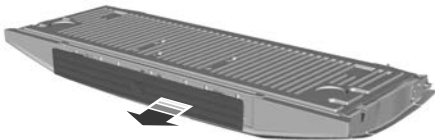
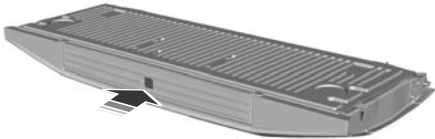

3. Pull the step out fully. Lower the step to its lowest position.



4. Pull the yellow handle stop backward out of the tailgate until it fully extends.
5. To lock the handle in place, rotate the handle up from the horizontal to the vertical position until you hear a click.

Note: Do not tow with the step or grab handle.

Replace the slip resistance tape or grab handle molding if it appears as worn or damaged.

To reduce the risk of falling:

- Only operate the step when your vehicle is on a level surface.
- Only operate the step in areas with sufficient lighting.
- Make sure you use the grab handle when climbing on the step.
- Do not use the step with bare feet.
- Make sure the step is clean before use.
- Keep the step load below the total maximum load of 159 kg (350 lb).

STOWING THE TAILGATE STEP

1. Press the yellow button on the handle to lower and then press the yellow lever at the bottom of the handle to unlock. Rotate the handle down from the vertical to the horizontal position and push it into the tailgate.

Tailgate - Vehicles With: Power Tailgate

2. Rotate the step up until it is horizontal, then push it back into the tailgate until the step is secure.

Note: Make sure to close and fully latch the step before moving your vehicle. Do not drive with the step or grab handle open.

Note: The power tailgate cannot close if the step is open. A warning message appears and a tone sounds. After stowing the step the power close function is restored.

TAILGATE – TROUBLESHOOTING

TAILGATE – WARNING LAMPS



Illuminates when the tailgate is not completely closed.

TAILGATE – INFORMATION MESSAGES

Message	Details
Tailgate Ajar	The tailgate is not completely closed.
Shift to Park to operate tailgate	The vehicle must be in park (P) or reverse (R) and below 4 km/h (2.5 mph) to open the tailgate. The tailgate can be closed in any gear below 4 km/h (2.5 mph)
Power Tailgate Stow Step	The step must be stowed for the tailgate to close.

Tailgate - Vehicles With: Power Tailgate

TAILGATE – FREQUENTLY ASKED QUESTIONS

Why won't my power tailgate open?

- Make sure the tailgate is in power mode.
- Make sure the vehicle is in park (P) or reverse (R) and the vehicle speed is less than 4 km/h.
- The tailgate will not close if your vehicle speed is at or above 4 km/h (2.5 mph).
- Make sure nothing is obstructing the tailgate path and or causing resistance such as tonneau cover or other aftermarket accessory, freezing conditions or being parked downhill.
- If you have continued issues, the battery voltage may be low or other system issues. See an authorized dealer.

Why won't my power tailgate close?

- Make sure the tailgate is in power mode.
- Make sure the ignition is on and the vehicle is in park (P) or reverse (R) and the vehicle speed is less than 4 km/h.
- The tailgate will not close if your vehicle speed is at or above 4 km/h (2.5 mph).
- Make sure nothing is obstructing the tailgate path and or causing resistance such as tonneau cover or other aftermarket accessory, freezing conditions or being parked downhill.
- If you have continued issues, the battery voltage may be low or other system issues. See an authorized dealer.

TAILGATE VIDEOS

[*Integrated Tailgate Step Video Link*](#)

[*Remote tailgate release Video Link*](#)

Tailgate - Vehicles With: Remote Power Tailgate Release

TAILGATE PRECAUTIONS



WARNING: It is extremely dangerous to ride in a cargo area, inside or outside of a vehicle. In a crash, people riding in these areas are more likely to be seriously injured or killed. Do not allow people to ride in any area of your vehicle that is not equipped with seats and seatbelts. Make sure everyone in your vehicle is in a seat and properly using a seatbelt. Failure to follow this warning could result in serious personal injury or death.



2. Press the button in the top of the tailgate handle twice within three seconds.

OPENING THE TAILGATE

OPENING THE TAILGATE FROM INSIDE YOUR VEHICLE

The vehicle must be in park (P) to operate the tailgate.



Press the button on the instrument panel twice within three seconds.

OPENING THE TAILGATE FROM OUTSIDE YOUR VEHICLE

1. Unlock the vehicle with the remote control or power door unlock control.

Note: If an intelligent access transmitter is within 1 m (3 ft) of the tailgate, the tailgate unlocks when you press the tailgate release button.

OPENING THE TAILGATE USING THE REMOTE CONTROL



Press the remote control button twice within three seconds.

REMOVING AND INSTALLING THE TAILGATE



WARNING: Always properly secure cargo to prevent shifting cargo or cargo falling from the vehicle. Failure to do so could result in compromised vehicle stability and serious personal injury to vehicle occupants or others.



WARNING: The tailgate is heavy. Removal of the tailgate requires two adults. Failure to follow this instruction could result in personal injury or property damage.

Tailgate - Vehicles With: Remote Power Tailgate Release

Note: Before removing the tailgate, make sure the tailgate removal kit with the protective caps is in the glove compartment. If it is not, one can be provided free of charge by your authorized dealer. Failure to install the protective caps results in damage to the electrical system not covered by the vehicle warranty.

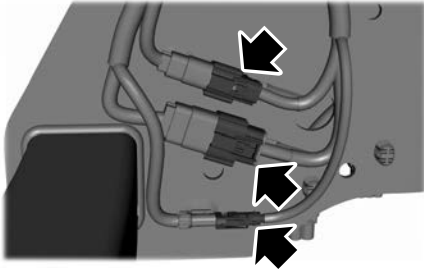

1. Locate and disconnect the frame connections. They are on the left-hand side of the vehicle.

Note: Your vehicle may have up to three frame connections.

2. Install the protective caps on the in-line connector portion that remains under the pickup box.
3. Partially lower the tailgate. Carefully feed the tailgate harness up through the gap between the pickup box and the bumper and place it out of the way under the pickup box.
4. Lower the tailgate.

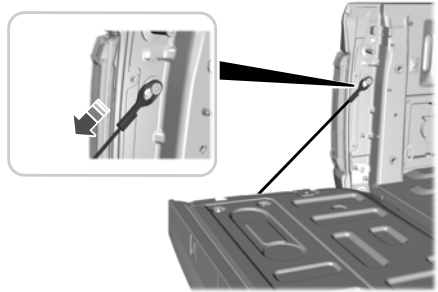

5. Use a screwdriver to gently pry the spring clip on each connector past the head of the support screw. Disconnect the cable.
6. Disconnect the other cable.
7. Lift the tailgate to 45 degrees from the horizontal position.
8. Lift the right-hand side off its hinge.
9. Lift the tailgate to 80 degrees from the horizontal position.
10. Remove the tailgate from the left-hand side hinge by sliding it to the right.
11. Install the tailgate in reverse order.

TAILGATE STEP

ACCESSING THE TAILGATE STEP

1. Lower the tailgate.
2. Push the button in the center of the step molding. The step pops out slightly.

Tailgate - Vehicles With: Remote Power Tailgate Release

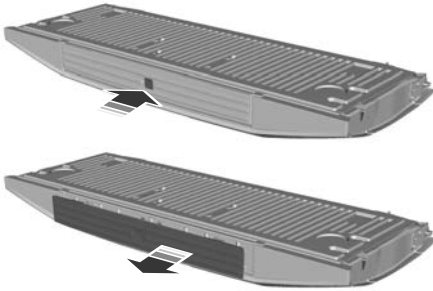

3. Pull the step out fully. Lower the step to its lowest position.



4. Pull the yellow handle stop backward out of the tailgate until it fully extends.
5. To lock the handle in place, rotate the handle up from the horizontal to the vertical position until you hear a click.

Note: Do not tow with the step or grab handle.

Replace the slip resistance tape or grab handle molding if it appears as worn or damaged.

To reduce the risk of falling:

- Only operate the step when your vehicle is on a level surface.
- Only operate the step in areas with sufficient lighting.
- Make sure you use the grab handle when climbing on the step.
- Do not use the step with bare feet.
- Make sure the step is clean before use.
- Keep the step load below the total maximum load of 159 kg (350 lb).

STOWING THE TAILGATE STEP

1. Press the yellow button on the handle to lower and then press the yellow lever at the bottom of the handle to unlock. Rotate the handle down from the vertical to the horizontal position and push it into the tailgate.
2. Rotate the step up until it is horizontal, then push it back into the tailgate until the step is secure.

Note: Make sure to close and fully latch the step before moving your vehicle. Do not drive with the step or grab handle open.

Note: The power tailgate cannot close if the step is open. A warning message appears and a tone sounds. After stowing the step the power close function is restored.

Tailgate - Vehicles With: Remote Power Tailgate Release

TAILGATE – TROUBLESHOOTING

TAILGATE – INFORMATION MESSAGES

Message	Action
Tailgate Ajar	The tailgate is not completely closed.
Shift to Park to operate tailgate	The vehicle must be in park (P) to operate the remote release tailgate.

Tailgate - Vehicles With: Remote Power Tailgate Release

TAILGATE – FREQUENTLY ASKED QUESTIONS

Why won't my tailgate open?

- Make sure the transmission is in park (P), ensure nothing is obstructing the tailgate path and or causing resistance (tonneau cover or other aftermarket accessories, freezing conditions or being parked downhill). If you have continued issues, the battery voltage may be low or other system issues. See an authorized dealer.

TAILGATE VIDEOS

[*Integrated Tailgate Step Video Link*](#)

[*Remote tailgate release Video Link*](#)

Security

PASSIVE ANTI-THEFT SYSTEM

WHAT IS THE PASSIVE ANTI-THEFT SYSTEM

The passive anti-theft system prevents someone from starting your vehicle with an incorrectly coded key.

Note: *Do not leave a duplicate coded key in your vehicle. Always take the keys and lock all the doors when leaving your vehicle.*

HOW DOES THE PASSIVE ANTI-THEFT SYSTEM WORK

The passive anti-theft system arms when you switch your vehicle off.

It disarms when you switch your vehicle on with a correctly coded key.

Note: *The system is not compatible with non-Ford aftermarket remote start systems.*

Note: *Do not leave a duplicate coded key in your vehicle. Always take the keys and lock all doors when leaving your vehicle.*

ANTI-THEFT ALARM SYSTEM

WHAT IS THE ANTI-THEFT ALARM SYSTEM

The anti-theft alarm system warns you of an unauthorized entry to your vehicle.

HOW DOES THE ANTI-THEFT ALARM SYSTEM WORK

When armed, the anti-theft alarm is triggered in any of the following ways:

- Opening a door, the tailgate or hood without a correctly coded key or remote control.
- If you turn the power on without a correctly coded key.
- Disconnecting the battery.
- Disconnecting the trailer. See **Connecting a Trailer** (page 359).

Any further attempts to carry out one of the above, sounds the alarm again.

If the anti-theft alarm is triggered, the alarm horn sounds for 30 seconds and the turn signals flash for five minutes.

WHAT IS THE PERIMETER ALARM

The perimeter alarm is designed to detect unauthorized access to your vehicle.

ARMING THE ANTI-THEFT ALARM SYSTEM

The alarm is ready to arm when you switch your vehicle off.

Lock your vehicle with your remote control to arm the alarm.

DISARMING THE ANTI-THEFT ALARM SYSTEM

Disarm the alarm by performing any of the following actions:

- Unlock the doors or luggage compartment with the remote control.
- Switch your vehicle on or start your vehicle.

Security

SECURITY – TROUBLESHOOTING

SECURITY – INFORMATION MESSAGES

Message	Details
No Key Detected	The system has not detected a correctly coded key.
Starting System Fault	The system has malfunctioned. Have your vehicle checked as soon as possible.
Vehicle Alarm To Stop Alarm, Start Vehicle.	Displays when the alarm has been triggered due to unauthorized entry.
Alarm	

Security

SECURITY – FREQUENTLY ASKED QUESTIONS

What should I do if there is a potential alarm problem with my vehicle?

- Take all remote controls to an authorized dealer if there is a potential alarm problem with your vehicle.

What should I do if my vehicle is unable to start with a correctly coded key?

- Have your vehicle checked as soon as possible.

Power Running Boards (If Equipped)

POWER RUNNING BOARD PRECAUTIONS



WARNING: Do not step on a running board that is moving or not fully deployed. Failure to follow this instruction may result in personal injury.



WARNING: Switch off the running boards before jacking or placing any object under your vehicle. Failure to follow this instruction may result in personal injury or property damage.



WARNING: Never place your hands or feet near a moving running board. Failure to follow this instruction may cause personal injury.

Note: The power running boards could be exposed to factors such as ice, mud, or rocks, causing the running boards to not deploy or stow properly. The power running boards resume normal operation once the mechanical device that allows movement of the running boards is cleaned and lubricated following the maintenance instructions.

POWER RUNNING BOARD SETTINGS

1. Press **Features** on the touchscreen.
2. Press **Power Running Board**.
3. Press **SETTINGS**.

Power Boards Modes

Note: When the vehicle speed is more than 5 km/h (3 mph), the option to select the modes disables, to avoid unintended operation.

Note: The power running boards reverse direction and move to the end of travel if they encounter an object when moving. Keep the power running boards and brackets clean for optimum performance.

Off

The power running boards remain stowed, regardless of door position.

Auto

The power running boards deploy when you approach your vehicle with a remote control, unlock the door or open the door.

The power running boards stow:

- After a few seconds when you close the doors.
- Instantly after you close and lock the doors.
- If you unlock the door but do not open it, after the timeout.
- If you have switched approach detection on and do not open a door before the auto timer setting expires.
- When the vehicle speed is more than 5 km/h (3 mph).

Note: When you select this mode, an option displays that allows you to select how long the running boards stay deployed without opening the door.

Out

The power running boards remain deployed, regardless of door position. The power running boards stow when the vehicle speed is more than 5 km/h, and the mode changes to auto. You need to select Out mode again if you want the power running boards to stay deployed at the end of each trip.

Power Running Boards (If Equipped)

Approach detection

When you switch approach detection on with auto switched on, the running boards deploy when you approach your vehicle with a remote control.

POWER RUNNING BOARDS – TROUBLESHOOTING

POWER RUNNING BOARDS – FREQUENTLY ASKED QUESTIONS

Why are my power running boards not deploying and/or stowing as expected?

- The power running boards may produce unwanted noises, move in and out randomly, move slowly, or get stuck mid-travel when the power running boards mechanism has trapped debris such as mud, dirt, snow, ice, and/or salt. If this happens, follow the maintenance procedure below.

What maintenance should my power running boards have?

- Set the running boards to the deployed position by selecting the out mode. Wash the system, in particular the front and rear hinge arms, with a high-pressure car wash wand. Avoid using a wand that is not designed for car wash use, as excessive water pressure could damage nearby components.
- Apply Motorcraft penetrating and lock lubricant to clean the bushing locations on both running board hinges. This removes any embedded rust or debris that pressure washing may not have removed. If any leftover debris or rust is present after using the penetrating lubricant, use a pressure washer to remove it.

- To help prevent power running board deployment issues, use lithium grease to help keep debris away from the moving parts of the running board. Apply Motorcraft® multi-purpose grease on each bushing location and the motor output shaft.
- Remember to properly clean the power running boards every time you notice slow movement or improper behavior. Apply multi-purpose grease to the mechanism every 6 months.

Steering Wheel

ADJUSTING THE STEERING WHEEL - VEHICLES WITH: MANUAL ADJUSTABLE STEERING COLUMN



WARNING: Do not adjust the steering wheel when your vehicle is moving.

Note: Make sure that you are sitting in the correct position. See **Sitting in the Correct Position** (page 148).

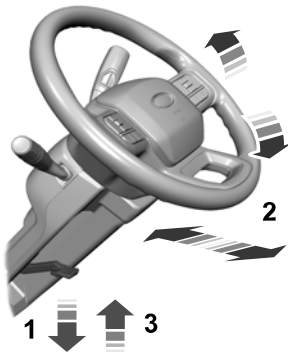

1. Unlock the steering column by pulling the lever down.
2. Adjust the steering wheel to the preferred position. The wheel can move up or down, in or out.
3. Lock the steering column into position by pushing the lever up into the locked position.

ADJUSTING THE STEERING WHEEL - VEHICLES WITH: POWER ADJUSTABLE STEERING COLUMN



WARNING: Do not adjust the steering wheel when your vehicle is moving.

Note: Make sure that you are sitting in the correct position. See **Sitting in the Correct Position** (page 148).



Use the control on the side of the steering column to adjust the position.

To adjust:

- Tilt: Press the top or bottom of the control.
- Telescope: Press the front or rear of the control.

Steering Wheel

End of Travel Position

The steering column sets a stopping position just short of the end of the column position to prevent damage to the steering column. A new stopping position sets if the steering column encounters an object when tilting or telescoping.

To reset the steering column to its normal stopping position:

1. Confirm there is nothing obstructing the motion of the steering column.
2. Press and hold the steering column control until the steering column stops moving.
3. Press the steering column control again.

Note: *The steering column may begin to move again.*

4. When the steering column stops, continue holding the control for a few seconds.
5. Repeat for each direction as necessary.

A new stopping position sets. The next time you tilt or telescope the steering column, it stops just short of the end of the column position.

Memory Feature (If Equipped)

You can save and recall the steering column position with the memory function. See **Memory Function** (page 164).

Pressing the adjustment control during a memory recall cancels the operation.

Easy Entry and Exit Feature

The column moves up when you switch the ignition off. Switch the ignition on to return the system to its previous settings. You can switch this feature on or off in the instrument cluster display.

Note: *If you press any adjustment or memory button when in easy exit mode, the system cancels the operation.*

Note: *Depending on your vehicle, the column may move up and in.*

RESETTING THE STOPPING POSITION - VEHICLES WITH: POWER ADJUSTABLE STEERING COLUMN

Note: *The steering wheel stops when it detects an obstruction. This sets a new stopping position.*

To reset the steering column to its normal stopping position:

1. Confirm there is nothing obstructing the motion of the steering column.
2. Press and hold the steering column control until the steering column stops moving.
3. Press the steering column control again.

Note: *The steering column may start to move again.*

4. When the steering column stops, continue holding the control for a few seconds.
5. Repeat for each direction, as necessary.

HORN



Press on the center of the steering wheel near the horn icon to activate the horn.

Steering Wheel

SWITCHING THE HEATED STEERING WHEEL ON AND OFF - VEHICLES WITH: HEATED STEERING WHEEL



WARNING: Use caution when using the heated steering wheel if you are unable to feel pain to your skin because of advanced age, chronic illness, diabetes, spinal cord injury, medication, exhaustion or other physical conditions. Failure to follow this instruction could result in personal injury, especially if the heated steering wheel is used for long periods of time.



To activate the heated steering wheel, press the button on the climate control unit. An indicator illuminates when the heated steering wheel is on. To turn it off, press the heated steering wheel button again.

Note: *The engine must be running to use the heated steering wheel.*

Note: *A sensor regulates the temperature of the steering wheel.*

Note: *The heated steering wheel may remain on after remote starting your vehicle, depending on the remote start settings. It may also turn on when you start your vehicle if it was on the last time the engine was switched off.*

Note: *In warm temperatures, the steering wheel quickly reaches its maximum temperature and the system reduces the current to the heating element. This could cause you to think that the system has stopped working but it has not. This is normal.*

Adjustable Pedals (If Equipped)

ADJUSTING THE PEDALS



WARNING: Do not use the pedal adjustment controls when the vehicle is moving. Failure to follow this instruction could result in personal injury or death.

Your control is on the left-hand side of the steering column or on the instrument panel.

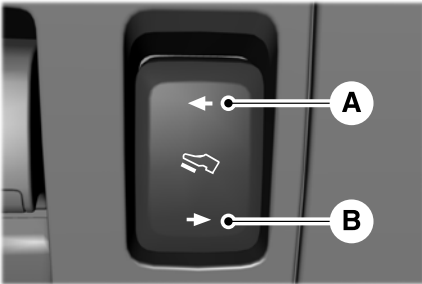

- A. Farther away from you.
- B. Closer to you.

You can save and recall the pedal positions with the memory feature. See **Memory Function** (page 164).

Wipers and Washers

WIPERS

WIPER PRECAUTIONS

Do not operate the wipers on a dry windshield. This could scratch the glass or damage the wiper blades. Use the windshield washers before wiping a dry windshield.

Fully defrost the windshield before you switch the windshield wipers on.

Switch the windshield wipers off before entering a car wash.

SWITCHING WINDSHIELD WIPERS ON AND OFF

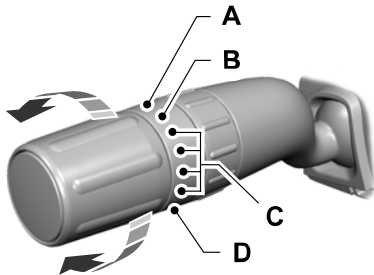

- A High-speed wipe.
- B Low-speed wipe.
- C Auto Wipe/Intermittent wipe.
- D Off.



Use the rotary control.

AUTOWIPERS (IF EQUIPPED)

WHAT ARE AUTOWIPERS

Autowipers turns on and controls the speed and frequency of the windshield wipers.

AUTOWIPERS SETTINGS

1. From the settings menu, press Vehicle.
2. Press Wipers.
3. Switch Rain sensing on or off.

Note: When you switch the feature off, the wipers do not operate based on the rain sensor. When you switch on the windshield wipers to the intermittent wipe position with the feature off, the wipers use the wipe speed set by the rotary control.

ADJUSTING THE SENSITIVITY OF THE RAIN SENSOR

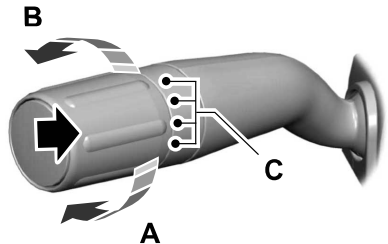

- A Low sensitivity.
- B High sensitivity.
- C Intermittent wipe/Autowipers.

Use the rotary control to set the rain sensor sensitivity.

Wipers and Washers

Note: Use intermittent wipe positions to adjust the rain sensor sensitivity.

When you select low sensitivity, the wipers operate when the sensor detects a large amount of water on the windshield.

When you select high sensitivity, the wipers operate when the sensor detects a small amount of water on the windshield.

CHECKING THE WIPER BLADES



Run the tip of your fingers over the edge of the blade to check for roughness.

REPLACING THE FRONT WIPER BLADES

Make sure your vehicle is off before beginning this procedure.

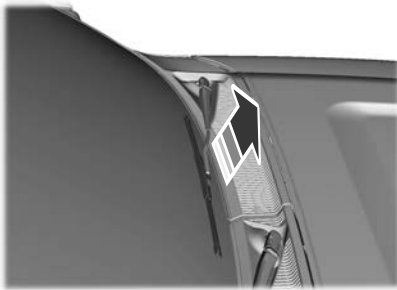

1. Pull the wiper blade and arm away from the glass.

Note: Do not hold the wiper blade to lift the wiper arm.

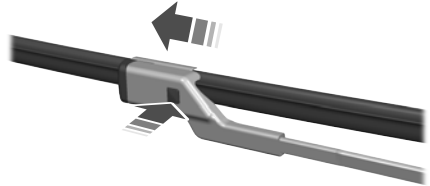

2. Press the wiper blade locking clip.
3. Remove the wiper blade.

Note: Make sure that the wiper arm does not spring back against the glass when the wiper blade is not attached.

4. To install, reverse the removal procedure.

Note: Make sure that the wiper blade locks into place.

WASHERS

WASHER PRECAUTIONS



WARNING: If you operate your vehicle in temperatures below 5°C (41°F), use washer fluid with antifreeze protection. Failure to use washer fluid with antifreeze protection in cold weather could result in impaired windshield vision and increase the risk of injury or accident.

Do not operate the washers when the washer reservoir is empty. This could cause the washer pump to overheat.

Wipers and Washers

Keep the outside of the windshield clean. The rain sensor is very sensitive and the wipers may operate if dirt, mist or insects hit the windshield.

USING THE WINDSHIELD WASHER

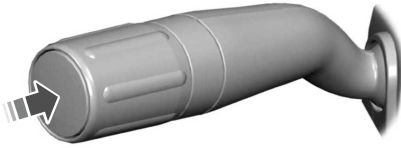

Press and hold the button at the end of the lever to operate the windshield washer.

Note: A courtesy wipe occurs a short time after the wipers stop to clear any remaining washer fluid when switched on. See **Switching the Courtesy Wipe On and Off** (page 107).

WASHER FLUID SPECIFICATION

Capacities

Variant	Quantity
All.	Fill as required.

SWITCHING THE COURTESY WIPE ON AND OFF

1. From the settings menu, press Vehicle.
2. Press Wipers.
3. Switch Courtesy Wipe on or off.

Note: When you switch the feature on, the wipers make an additional single wipe at the end of the washer request. When you switch it off, the wipers finish the current washer request.

ADDING WASHER FLUID

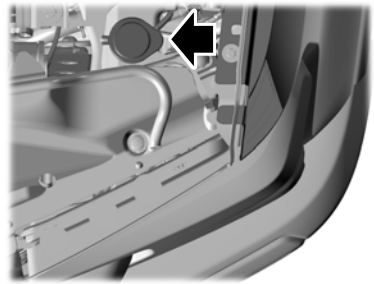

Wipers and Washers

Materials

Name	Specification
Motorcraft® Premium Windshield Wash Concentrate with Bitterant(U.S.) Motorcraft® Premium Quality Windshield Washer Fluid -35 °C / Liquide lave-glace de haute qualité - 35 °C Motorcraft®(Canada) ZC-32-B2(U.S.) CXC-37-M(Canada)	WSS-M14P19-A

WIPERS AND WASHERS VIDEOS

[Improving Your Windshield Wiper Performance Video Link](#)

[Courtesy Wipe Video Link](#)

WIPERS AND WASHERS – TROUBLESHOOTING

WIPERS AND WASHERS – WARNING LAMPS



Illuminates when the windshield washer fluid is low.

WIPERS AND WASHERS – FREQUENTLY ASKED QUESTIONS

Why are there streaks and smears on the windshield?

- The wiper blades could be dirty, worn or damaged. Check the wiper blades. See **Checking the Wiper Blades** (page 106). If the wiper blades are dirty, clean them with washer fluid or water applied with a soft sponge or cloth. If the wiper blades are worn or damaged, install new ones. See **Replacing the Front Wiper Blades** (page 106).

Exterior Lighting

EXTERIOR LIGHTING CONTROL

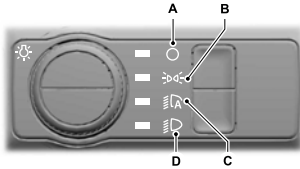

- A Lamps off.
- B Parking lamps on.
- C Autolamps on.
- D Headlamps on.

Rotate the control to make a selection.

Note: The lighting control defaults to autolamps every time you switch your vehicle on.

HEADLAMPS

USING THE HIGH BEAM HEADLAMPS

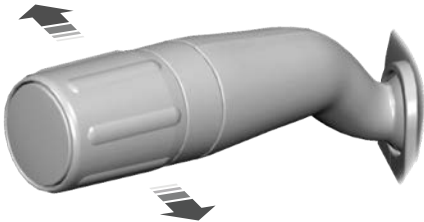

 Push the lever away from you to switch the high beam on.

Push the lever forward again or pull the lever toward you to switch the high beams off.

Slightly pull the lever toward you and release it to flash the headlamps.

Note: Continuous activation only with headlamps on.

SWITCHING HEADLAMP EXIT DELAY ON AND OFF

To switch headlamp exit delay on, pull the turn signal lever toward you when the headlamps are off and the ignition is off. A short tone sounds when the system is on.

To switch headlamp exit delay off, pull the turn signal lever toward you again or switch your vehicle on.

Note: The headlamps turn off after three minutes with any door open or 30 seconds after the last door closes.

ADJUSTING THE LEVEL OF THE HEADLAMPS

Your vehicle has a dynamic leveling system. The headlamps do not require additional aim adjustment.

HEADLAMP INDICATORS

Lamps On



Illuminates when you switch the low beam headlamps or the parking lamps on.

Headlamp High Beam



Illuminates when you switch the high beam headlamps on.

Exterior Lighting

HEADLAMPS – TROUBLESHOOTING

HEADLAMPS – FREQUENTLY ASKED QUESTIONS

Why is there condensation in the headlamps?

- Headlamps have vents to accommodate normal changes in air pressure. Condensation can be a natural by-product of this design. When moist air enters the lamp assembly through the vents, there is a possibility that condensation can occur when the temperature is cold. When normal condensation occurs, a fine mist can form on the interior of the lens. The fine mist eventually clears and exits through the vents during normal operation.

How much condensation is acceptable?

- The presence of a fine mist or small droplets without streak marks is normal condensation. This may occur under certain environmental conditions and will clear on its own.

How long does it take for the acceptable condensation to clear?

- Clearing time may vary depending on the outside temperature and environment, the drive duration and speed.

How much condensation is unacceptable?

- A water puddle inside the lamp. Streaks, drip marks or large droplets present on the interior of the lens.

What should I do if unacceptable condensation is present?

- Have your vehicle checked as soon as possible.

Why do my headlamps turn off when I have them switched on when I switch my vehicle off?

- The battery saver turns the headlamps off after a short period of time after you switch your vehicle off.

AUTOLAMPS

WHAT ARE AUTOLAMPS



WARNING: The system does not relieve you of your responsibility to drive with due care and attention. You may need to override the system if it does not turn the headlamps on in low visibility conditions, for example daytime fog.

Autolamps turn the headlamps on in low light situations or when the windshield wipers operate.

AUTOLAMP SETTINGS

Autolamp Exit Delay

You can adjust the amount of time the autolamps remain on after you switch off your vehicle. Use the touchscreen to choose a delay setting.

1. From the settings menu, press Vehicle.
2. Press Lighting.
3. Press Autolamp Delay.
4. Select a setting.

Note: *If the setting is off, the external lamps switch off immediately when you shut down your vehicle.*

Exterior Lighting

Note: You can pull the turn signal toward you to manually switch off the autolamp exit delay.

Note: Only the cornering lamp on the side your vehicle is turning illuminates.

Note: Cornering lamps do not operate if you switch the front fog lamps on.

EXTERIOR LAMPS

USING THE TURN SIGNAL LAMPS

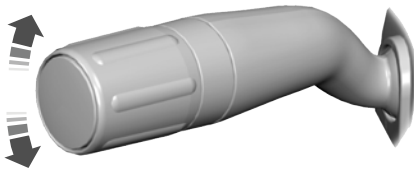

Push the lever up or down to switch the turn signal lamps on.

Set the lever to the middle position to switch the turn signal lamps off.

Note: Tap the lever up or down to make the turn signal lamps flash three times.

Turn Signal Lamp Indicator



It flashes when you switch the turn signal lamps on.

Note: An increase in the rate of flashing warns of a failed turn signal lamp.

HOW DO CORNERING LAMPS WORK

The cornering lamps illuminate the inside of a corner when you are turning the steering wheel or when you switch the turn signal lamps on. They turn on when the vehicle speed is below 40 km/h (25 mph).

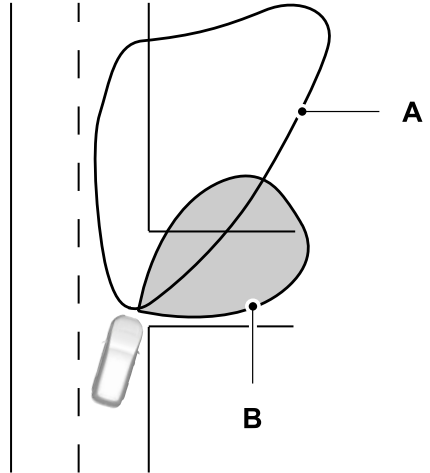

A Headlamp beam.

B Cornering lamp beam.

SWITCHING THE DAYTIME RUNNING LAMPS ON AND OFF - VEHICLES WITH CONFIGURABLE DAYTIME RUNNING LAMPS



WARNING: The daytime running lamps system does not activate the rear lamps and may not provide adequate lighting during low visibility driving conditions. Make sure you switch the headlamps on, as appropriate, during all low visibility conditions. Failure to do so may result in a crash.

Exterior Lighting

1. From the settings menu, press Vehicle.
2. Press Lighting.
3. Switch Daytime Running Lights on or off.

The daytime running lamps turn on when all of the following occur:

- You switch the system on.
- You switch the vehicle on.
- The transmission is not in park (P) for vehicles with automatic transmissions or you release the parking brake for vehicles with manual transmissions.
- The lighting control is in the autolamps position.
- The headlamps are off.

Note: Other lighting control positions do not turn on the daytime running lamps.

SWITCHING THE DAYTIME RUNNING LAMPS ON AND OFF - VEHICLES WITH: DAYTIME RUNNING LAMPS (DRL)



WARNING: The daytime running lamps system may not activate the rear lamps and may not provide adequate lighting during low visibility driving conditions. Make sure you switch the headlamps on, as appropriate, during all low visibility conditions. Failure to do so may result in a crash.

Daytime running lamps are always on unless you switch on the headlamps or your vehicle is in park (P).

USING THE FRONT FOG LAMPS (if Equipped)

To switch the lamps on or off:

1. Set the lighting control to the parking lamps, headlamps or autolamps position.

Note: When the lighting control is in the autolamps position, you cannot switch the fog lamps on unless the low beam headlamps are on.

- 2.



Press the button on the lighting control to switch the front fog lamps on or off.

Note: Only switch the front fog lamps on during reduced visibility.

Note: The brightness of the daytime running lamps may decrease when the front fog lamps are switched on.

Note: The front fog lamps lights switch off automatically when high beams are activated.

Front Fog Lamps Indicator



It illuminates when you switch the front fog lamps on.

SWITCHING THE CARGO LAMPS ON (if Equipped)



Press the button in the lighting control or in the rear cargo box.

SWITCHING THE SPOT LAMPS ON AND OFF (if Equipped)

The spot lamp buttons are near the lighting control.



Press the button to switch on the left-hand spot lamp.



Press the button to switch on the right-hand spot lamp.

Exterior Lighting

Move the position of the exterior mirrors to adjust the aim.

Note: Make sure you switch your vehicle on, with the vehicle in accessory mode or running.

Note: The spot lamps turn off after 10 km/h (6 mph).

Note: The spot lamps illuminate the area in front of and to the side of your vehicle.

SWITCHING WELCOME LIGHTING ON AND OFF

The system turns on the exterior lamps when you approach your vehicle with an authenticated device, unlock your vehicle or interact with any of the doors. If you open or close any door, the lamps stay on for a short period of time to provide courtesy lighting.

Note: Welcome lighting still displays when you use your remote control to unlock your vehicle or interact with any of the doors.

To switch the system on or off:

1. Press Settings on the touchscreen.
2. Press Vehicle.
3. Press Lighting.
4. Switch welcome lighting on or off.

Note: Depending on your vehicle's configuration, you may not have the option to switch the feature on and off.

To conserve power, the system may not work when you are approaching your vehicle if:

- The 12-volt battery is low.
- The system was triggered 10 times prior to starting the vehicle.
- The vehicle is left unused for a few days.

EXTERIOR LAMPS ON AUDIBLE WARNING

Sounds when you open the driver door and the exterior lamps are on.

EXTERIOR ZONE LIGHTING (IF EQUIPPED)

WHAT IS EXTERIOR ZONE LIGHTING

Exterior zone lighting divides the exterior lighting into zones and allows you to switch them on and off to provide lighting around the perimeter of your vehicle.

USING THE EXTERIOR ZONE LIGHTING

1. Press **Features** on the touchscreen.
2. Press **Zone Lighting**.

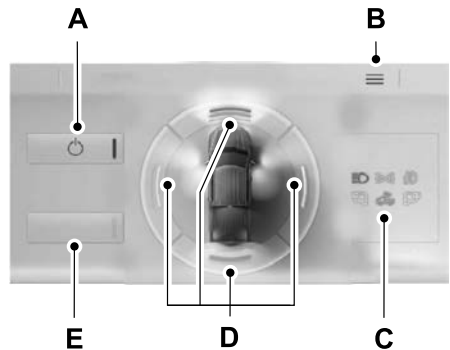

- A On and off button.
B Settings menu.
C Exterior lamp indicators.

Exterior Lighting

- D Individual zones on and off.
- E All zones on and off.

You can use zone lighting when your vehicle is on or off. When it is off, the lighting turns off after a certain period of time.

You can also use individual zone controls to switch on each zone.

Note: *Make sure to remove exterior lighting covers when using zone lighting.*

Note: *When your vehicle is off and the timer has one minute remaining, the turn signals flash six times.*

Note: *Indicators on the touchscreen illuminate when the lights outside of the zone lighting control are on.*

Note: *Vehicles without spot lamps only have two zones.*

EXTERIOR ZONE LIGHTING SETTINGS

1. Press **Features** on the touchscreen.
2. Press **Zone Lighting**.
3. Press the settings menu in the upper right-hand corner.
4. Press a setting.

Enable Autolamp Override

This setting allows your vehicle to override the autolamps when using zone lighting.

When you access zone lighting for the first time, you can choose this setting. You can change this setting at any time.

Include Reverse Lamps

This setting turns the reverse lamps on when you switch the rear lighting zone on.

Switch this setting off if you have a backup alarm installed to prevent the reverse lamps from turning on and sounding the alarm when using zone lighting.

AUTOMATIC HIGH BEAM CONTROL (IF EQUIPPED)

HOW DOES AUTOMATIC HIGH BEAM CONTROL WORK

Automatic high beam control turns the high beams on if it is dark enough and no other traffic is present. If it detects an approaching vehicle's headlamps or tail lamps, or street lighting ahead, the system turns the high beams off.

A camera sensor, centrally mounted behind the windshield of your vehicle, continuously monitors conditions to turn the high beams on and off.

Exterior Lighting

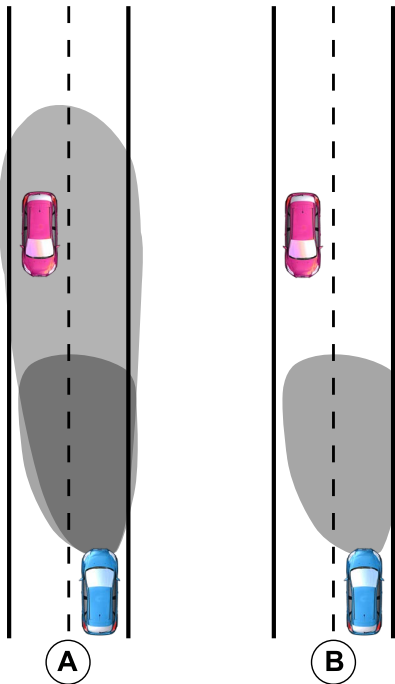

- A Without automatic high beam control.
- B With automatic high beam control.

AUTOMATIC HIGH BEAM CONTROL PRECAUTIONS

WARNING: The system does not relieve you of your responsibility to drive with due care and attention. You may need to override the system if it does not turn the high beams on or off.

- WARNING:** The system may not switch the high beams off if the lights of oncoming vehicles are hidden by obstacles, for example guard rails.
- WARNING:** You may need to override the system when approaching other road users.
- WARNING:** In situations with poor visibility, such as fog, heavy rain or other inclement weather, you may need to override or completely switch off the system.

AUTOMATIC HIGH BEAM CONTROL REQUIREMENTS

The system turns the high beams on if all of the following occur:

- You switch the system on.
- You set the lighting control to the autolamps position.
- The ambient light level is low enough that you require high beams.
- There is no traffic in front of your vehicle.
- The vehicle speed is greater than approximately 40 km/h (25 mph).

AUTOMATIC HIGH BEAM CONTROL LIMITATIONS

The system turns the high beams off if any of the following occur:

- You switch the system off.
- You set the lighting control to any position except autolamps.
- The ambient light level is high enough that you do not require high beams.
- The system detects an approaching vehicle's headlamps or a leading vehicle's tail lamps.

Exterior Lighting

- The system detects severe rain, snow or fog.
- The system detects street lighting.
- The camera has reduced visibility.
- The vehicle speed falls below approximately 30 km/h (19 mph).

Note: The deactivation speed may be lower on curves.

SWITCHING AUTOMATIC HIGH BEAM CONTROL ON AND OFF

1. Using the instrument cluster controls on the steering wheel, select **Settings**.
2. Select **Vehicle**.
3. Select **Lighting**.
4. Switch **Auto High Beam** on or off.

AUTOMATIC HIGH BEAM CONTROL INDICATORS



Illuminates to confirm when the system is ready to assist.

AUTOMATIC HIGH BEAM CONTROL – TROUBLESHOOTING (IF EQUIPPED)

AUTOMATIC HIGH BEAM CONTROL – INFORMATION MESSAGES

Message	Details
Front Camera Low Visibility Clean Screen	The camera has reduced visibility. Clean the windshield. If the message continues to appear, have your vehicle checked as soon as possible.
Front Camera Temporarily Not Available	The camera has malfunctioned. Wait a short period of time for the camera to cool down. If the message continues to appear, have your vehicle checked as soon as possible.
Front Camera Malfunction Service Required	The camera has malfunctioned. Have your vehicle checked as soon as possible.

OVERRIDING AUTOMATIC HIGH BEAM CONTROL

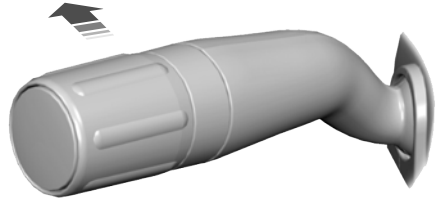

Push the lever away from you to switch the high beams on.

Push the lever away from you again to switch the high beams off.

Push the lever away from you for a third time to switch automatic high beam control back on.

Exterior Lighting

ADAPTIVE FRONT LIGHTING (IF EQUIPPED)

HOW DOES ADAPTIVE FRONT LIGHTING WORK

Adaptive front lighting adjusts the headlamps to improve visibility in certain situations.

Note: There are several types of adaptive front lighting. Availability and activation conditions may vary based on your vehicle.

Switching Adaptive Front Lighting On or Off

Set the lighting control to the autolamps position to use adaptive front lighting.

Note: Other lighting control positions do not turn on adaptive front lighting.

Adaptive Front Lighting Types

Name	Details
Speed Dependent Light Mode	Provides additional light on the road depending on your vehicle speed and weather conditions.
Dynamic Bending Light	Directs the light beam based on your steering around a curve. Additionally, lane markings detected by the front windshield camera and map data also help direct the light beam.
Static Bending Light	Adds lighting at the inside of a curve or corner when you are turning the steering wheel.
Sign Based Light Mode	Activates targeted lighting when certain traffic signs are detected in intersection and roundabout scenarios.

Note: This feature may use map data. We recommend having all connected vehicle settings enabled to allow the map content to be updated to the latest version. See **Connected Vehicle Settings** (page 544). If your vehicle does not receive automatic updates, take your vehicle to an authorized dealer to receive periodic updates.

[Auto High Beams Video Link](#)

[Configurable Daytime Running Lamps Video Link](#)

EXTERIOR LIGHTING VIDEOS

[Intelligent Three Blink Turn Signal Video Link](#)

Interior Lighting

SWITCHING ALL OF THE INTERIOR LAMPS ON AND OFF

The lamps turn on under the following conditions:

- You open any door.
- You press a button on the remote control.
- You press the all lamps on button on the overhead console.



Press to switch all interior lamps on or off.

SWITCHING THE FRONT INTERIOR LAMPS ON AND OFF



The front interior lamp switches are on the overhead console.

Note: The position of each button on the overhead console depends on your vehicle.

Individual Map Lamps



Press to switch the left-hand individual dome lamp on and off.



Press to switch the right-hand individual dome lamp on and off.

SWITCHING THE REAR INTERIOR LAMPS ON AND OFF



The rear interior lamps may be above the rear seat or above the rear windows.



Press to switch the lamps on or off.

Note: If you switch the rear lamps on through the overhead console, you cannot switch them off with the rear lamp switch.

INTERIOR LAMP FUNCTION

WHAT IS THE INTERIOR LAMP FUNCTION

The interior lamp function switches the courtesy and door lamps on or off.

SWITCHING THE INTERIOR LAMP FUNCTION ON AND OFF



Press to switch the interior lamp function on and off.

Note: The indicator lamp illuminates amber when the door function is off.

Interior Lighting

ADJUSTING THE INSTRUMENT PANEL LIGHTING BRIGHTNESS

The instrument lighting dimmer buttons are on the lighting control.



Repeatedly press one of the buttons to adjust the brightness.



Note: *There are six levels of brightness adjustments available during the day and twelve levels of brightness adjustments available at night.*

AMBIENT LIGHTING (IF EQUIPPED)

SWITCHING AMBIENT LIGHTING ON AND OFF

1. From the settings menu, press Vehicle.
2. Press Ambient Lighting.
3. Switch ambient lighting on or off.

Note: *You can also drag the slider all the way to the left to switch ambient lighting off.*

ADJUSTING AMBIENT LIGHTING

Drag the slider left or right to adjust the ambient lighting intensity.

INTERIOR LIGHTING – TROUBLESHOOTING

INTERIOR LIGHTING – FREQUENTLY ASKED QUESTIONS

Why do my courtesy lamps or interior lamps turn off when I have them switched on when I switch my vehicle off?

- The battery saver turns the courtesy lamps and interior lamps off after a short period of time after you switch your vehicle off.

Windows

OPENING AND CLOSING THE WINDOWS



WARNING: Do not leave children or pets unattended in your vehicle and do not let children play with the power windows. Failure to follow this instruction could result in personal injury or death.



WARNING: When closing the power windows, verify that they are free of obstructions and make sure children and pets are not in the proximity of the window openings. Failure to follow this instruction could result in personal injury or death.



WARNING: If an obstruction is detected, release the switch and reverse the window immediately. Failure to follow this instruction could result in personal injury or death.



WARNING: Do not leave a key or remote control unattended in the vehicle. Children or pets could operate the power windows and could become trapped in a closing window. Failure to follow this instruction could result in personal injury or death.



Press the window control switch to open the window. Lift the window control switch to close the window.

Note: The power windows operate with the ignition on, and for several minutes after you switch the ignition off or until you open a front door.

To reduce wind noise or pulsing noise when one window is open, slightly open the opposite window.

One-Touch Open

Fully press the window control switch and release it. Press again or lift it to stop the window.

One-Touch Close

Fully lift the window control switch and release it. Press again or lift it to stop the window.

Resetting One-Touch Close

Carry out all steps within 30 seconds of starting the sequence.

1. Close the window.
2. Press and hold the window control switch until the window is fully open. Keep the window control switch pressed for a few seconds.
3. Lift and hold the window control switch until the window is fully closed. Keep the window control switch held for a few seconds.
4. Press and hold the window control switch until the window is fully open. Keep the window control switch pressed for a few seconds.
5. Lift and hold the window control switch until the window is fully closed. Keep the window control switch held for a few seconds.

Note: Repeat the procedure if the window does not close when you use one-touch.

GLOBAL OPENING

WHAT IS GLOBAL OPENING

You can use the remote control to open the windows with the ignition off.

Windows

USING GLOBAL OPENING

1. Press and release the unlock button on the remote control.
2. Press and hold the unlock button on the remote control.
3. Release the button when the windows start to open.

Press the lock or the unlock button on the remote control to stop global opening.

Note: You can use global opening for a short period of time when you unlock your vehicle using the remote control.

SWITCHING GLOBAL OPENING ON AND OFF

1. Press **Settings** on the touchscreen.
2. Press **Vehicle**.
3. Press **Windows**.
4. Switch **Remote Open** on or off.

WINDOW BOUNCE-BACK

WHAT IS WINDOW BOUNCE-BACK

The window stops and reverses if it detects an obstruction when closing.

OVERRIDING WINDOW BOUNCE-BACK



WARNING: If you override bounce-back, the window does not reverse if it detects an obstacle. Take care when closing the windows to avoid personal injury or damage to your vehicle.

1. Close the window until it reaches the point of resistance and let it reverse.

2. Lift and hold the window control switch within two seconds to override bounce-back and close the window. Bounce-back is now disabled and you can close the window manually.

Note: The window goes past the point of resistance and you can fully close it.

Note: If the window does not close, have your vehicle checked as soon as possible.

LOCKING THE REAR WINDOW CONTROLS - CREW CAB/ SUPERCAB



WARNING: When children and pets are in the rear seat, use the power window lockout button to prevent accidental operation of the power windows.



Press the window control switch to lock or unlock the rear window controls. It illuminates when you lock the rear window controls.

OPENING AND CLOSING THE SLIDING WINDOWS - VEHICLES WITH: POWER SLIDING REAR WINDOW



WARNING: Do not leave children or pets unattended in your vehicle and do not let children play with the power windows. Failure to follow this instruction could result in personal injury or death.

Windows



WARNING: When closing the power windows, verify that they are free of obstructions and make sure children and pets are not in the proximity of the window openings. Failure to follow this instruction could result in personal injury or death.



WARNING: If an obstruction is detected, release the switch and reverse the window immediately. Failure to follow this instruction could result in personal injury or death.



WARNING: Do not leave a key or remote control unattended in the vehicle. Children or pets could operate the power windows and could become trapped in a closing window. Failure to follow this instruction could result in personal injury or death.

WINDOWS VIDEOS

[One-Touch Power Windows - Troubleshooting Video Link](#)

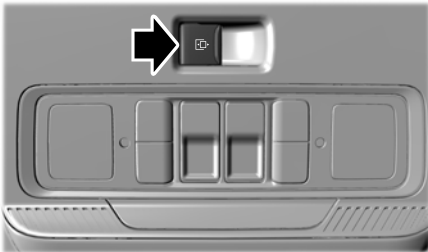

The sliding rear window control switch is on the overhead console.

Press and hold the sliding rear window control switch to open the rear window. Pull and hold the sliding rear window control switch to close the rear window.

Interior Mirror

INTERIOR MIRROR PRECAUTIONS



WARNING: Do not adjust the mirrors when your vehicle is moving. This could result in the loss of control of your vehicle, serious personal injury or death.

Note: Do not clean the mirror housing or glass with harsh abrasives, fuel or other petroleum-based cleaning products.

MANUALLY DIMMING THE INTERIOR MIRROR

Pull the tab below the mirror toward you to reduce glare at night.

AUTO-DIMMING INTERIOR MIRROR (IF EQUIPPED)

WHAT IS THE AUTO-DIMMING INTERIOR MIRROR

The mirror dims to reduce the effect of bright light from behind. It returns to normal when the bright light from behind is no longer present or if you shift into reverse (R).

AUTO-DIMMING INTERIOR MIRROR LIMITATIONS

Do not block the sensors on the front and back of the mirror.

Note: A rear center passenger or raised rear center head restraint could prevent light from reaching the sensor.

Exterior Mirrors

ADJUSTING THE EXTERIOR MIRRORS



WARNING: Do not adjust the mirrors when your vehicle is moving. This could result in the loss of control of your vehicle, serious personal injury or death.

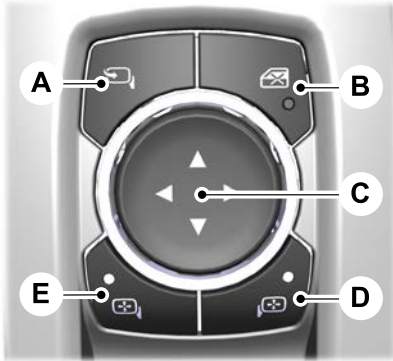

- A Power fold.
- B Window lock.
- C Adjustment control.
- D Right-hand mirror.
- E Left-hand mirror.

To adjust the mirrors, switch your vehicle on and place the ignition in accessory or start.

1. Select the mirror you want to adjust. The control light turns on.
2. Use the adjustment control to adjust the position of the mirror.
3. Press the mirror control again. The control light turns off.

FOLDING THE EXTERIOR MIRRORS - VEHICLES WITH: MANUAL FOLDING MIRRORS

Push the mirror toward the door window glass.

Make sure that you fully engage the mirror in its support when returning it to its original position.

FOLDING THE EXTERIOR MIRRORS - VEHICLES WITH: POWER FOLDING MIRRORS

The exterior mirrors fold when you lock your vehicle and unfold when you unlock your vehicle.

Note: This feature requires you to switch the exterior mirrors auto fold on.



For tight parking conditions, press the control switch to fold the mirrors.

Press the control switch again to unfold the mirrors.

Note: Do not stop the mirrors midway through their movement. Wait until the mirrors stop moving and press the control again.

The left-hand and right-hand mirrors move at different rates. For example, one mirror may stop while the other one continues to move. This is normal.

If you press the control switch to fold the mirrors with auto fold on, the mirrors do not unfold when you unlock your vehicle.

Note: The power folding mirrors operate with the vehicle on, and for several minutes after you switch the vehicle off.

Exterior Mirrors

Note: *If you fold and unfold the mirrors several times within one minute, the power fold function may turn off to protect the motors from overheating. Wait approximately three minutes with your vehicle running, and up to 10 minutes with your vehicle off, for the system to reset and operate as normal.*

Switching Auto fold On and Off

1. From the settings menu, press Vehicle. See **Center Display** (page 558).
2. Press Mirrors.
3. Switch Autofold on or off.

Loose, Noisy or Intermittently Working Mirrors

If you manually fold the power folding mirrors, they may not work properly even after you reposition them. Reset the mirrors if:

- They vibrate when you drive.
- They feel loose.
- They do not stay in the folded or unfolded position.
- One of the mirrors is not in its normal driving position.
- The mirrors are intermittently working.

To reset the power fold feature, use the power folding mirror control to fold and unfold the mirrors. You may hear a loud noise as you reset the power folding mirrors. This sound is normal. Operate the power folding mirrors an additional 3 to 4 times to synchronize the mirrors.

If the above process does not help you to fix the mirror, perform the following steps.

1. Fold or retract both mirrors manually.
2. Using the power folding control switch, operate the mirrors until you hear an audible click.

3. Operate the power folding an additional 3 to 4 times to synchronize the mirrors.

Repeat this process as needed each time you manually fold the mirrors.

EXTENDING THE EXTERIOR MIRRORS

This optional feature lets you extend the mirror about 75 mm (3 in). It is useful when towing a trailer. You can manually pull out or push in the mirrors to various positions.

Power Telescoping Mirrors (if Equipped)

This feature lets you position both mirrors at the same time.



- A. Extend.
- B. Retract.

To adjust your mirrors, make sure you switch your vehicle on, with the ignition in accessory mode or the engine running.

1. Press and release the control switch.
2. Press the adjustment control to position the mirrors.
3. Press the left arrow to extend the mirrors out. Press the right arrow to retract the mirrors in.

Exterior Mirrors

Note: *Moving the mirrors 10 or more times within one minute, or repeated folding and unfolding of the mirrors when holding the control down during full travel, could disable the system to protect the motors from overheating. Wait approximately three minutes with the vehicle running, and up to 10 minutes with the vehicle off, for the system to reset and for function to return to normal.*

EXTERIOR MIRRORS VIDEOS

[Resynchronization of your power-folding mirrors Video Link](#)

[PowerScope power telescoping mirrors Video Link](#)

Glass Roof (If Equipped)

OPENING AND CLOSING THE SUNSHADE



WARNING: Do not leave a key or remote control unattended in the vehicle. Children or pets could operate the sunshade and get caught in a closing sunshade. Failure to follow this instruction could result in personal injury.



WARNING: Do not leave children or pets unattended in your vehicle and do not let children play with the sunshade. Failure to follow this instruction could result in personal injury.

The controls are on the overhead console.

Opening the Sunshade



Press and release the switch to activate the one-touch open feature. To stop movement, press the switch a second time. The sunshade also opens when you open the glass roof.

Note: *The sunshade stops short of its fully opened position for the comfort of rear passengers. To fully open the sunshade, press the switch again.*

Closing the Sunshade



WARNING: When closing the sunshade, verify that it is free of obstructions and make sure children and pets are not in the proximity of the sunshade. Failure to follow this instruction could result in personal injury.



WARNING: If an obstruction is detected, press the switch a second time and reverse the sunshade immediately. Failure to follow this instruction could result in personal injury.



Press and release the switch to activate the one-touch close feature. To stop movement, press the switch a second time.

Note: *If fully open, the sunshade stops after covering the rear glass panel. Press and release again to fully close the sunshade.*

Note: *If the glass roof is either in the open or vent position and the sunshade is in the mid-open position, press and release the switch to close the glass roof first and then the sunshade.*

OPENING AND CLOSING THE GLASS ROOF



WARNING: Do not allow anyone to stand or place any portion of their body through the open glass roof while the vehicle is in motion. Make sure everyone in your vehicle is in a seat and properly using a seatbelt. Failure to follow this warning could result in serious injury or death in the event of a sudden stop or crash.



WARNING: Do not leave children or pets unattended in your vehicle and do not let children play with the glass roof. Failure to follow this instruction could result in personal injury.

Glass Roof (If Equipped)



WARNING: Do not leave a key or remote control unattended in the vehicle. Children or pets could operate the glass roof and could become trapped in a closing glass roof. Failure to follow this instruction could result in personal injury or death.

The controls are on the overhead console.

Opening the Glass Roof



Press and release the switch to activate the one-touch open feature. To stop movement, press the switch a second time.

Note: *The glass roof stops short of the fully opened position to reduce wind noise or rumbling that may happen with the glass roof fully open.*

Press and release the switch again to fully open the glass roof.

Closing the Glass Roof



WARNING: When closing the glass roof, verify that it is free of obstructions and make sure children and pets are not in the proximity of the glass roof. Failure to follow this instruction could result in personal injury or death.



WARNING: If an obstruction is detected, release the switch and reverse the glass roof immediately. Failure to follow this instruction could result in personal injury or death.



Press and release the switch to activate the one-touch close feature, from either the open or vent positions. To stop movement, press the switch a second time.

VENTING THE GLASS ROOF



WARNING: Do not leave children or pets unattended in your vehicle and do not let children play with the glass roof. Failure to follow this instruction could result in personal injury.

The glass roof controls are on the overhead console.



With the glass roof in the closed position, press and release the switch to vent the glass roof. To close the glass roof from the vent position, press and release the switch again.

GLASS ROOF BOUNCE-BACK

WHAT IS GLASS ROOF BOUNCE-BACK

The glass roof stops and reverses some distance if it detects an obstacle when closing.

OVERRIDING GLASS ROOF BOUNCE-BACK

Press and hold the close switch within two seconds after the glass roof comes to a stop.

Instrument Cluster

INSTRUMENT CLUSTER OVERVIEW - VEHICLES WITH: 4.2 INCH SCREEN

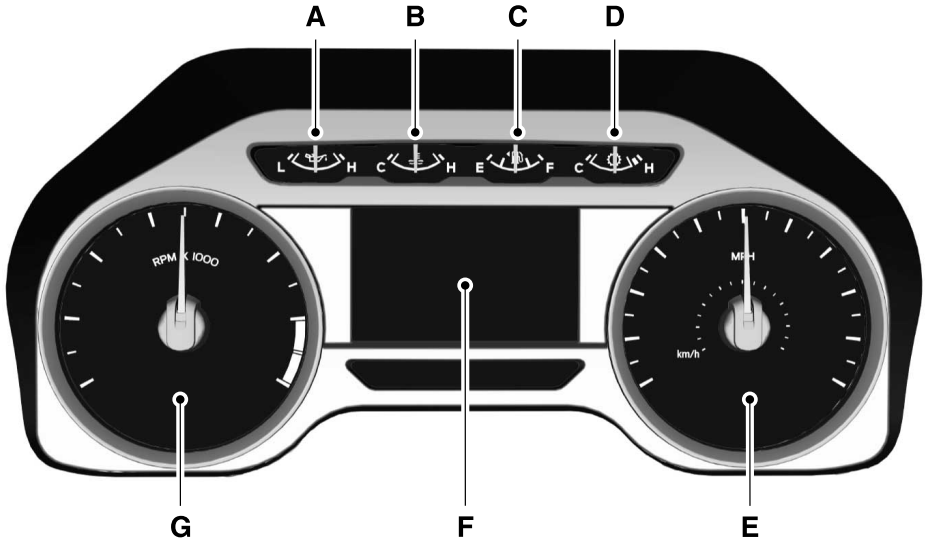

- A Engine oil pressure gauge.
- B Engine coolant temperature gauge.
- C Fuel gauge.
- D Transmission fluid temperature gauge (gas), turbo boost (diesel).
- E Speedometer.
- F Instrument cluster display.
- G Tachometer.

Instrument Cluster

INSTRUMENT CLUSTER OVERVIEW - VEHICLES WITH: 12 INCH SCREEN

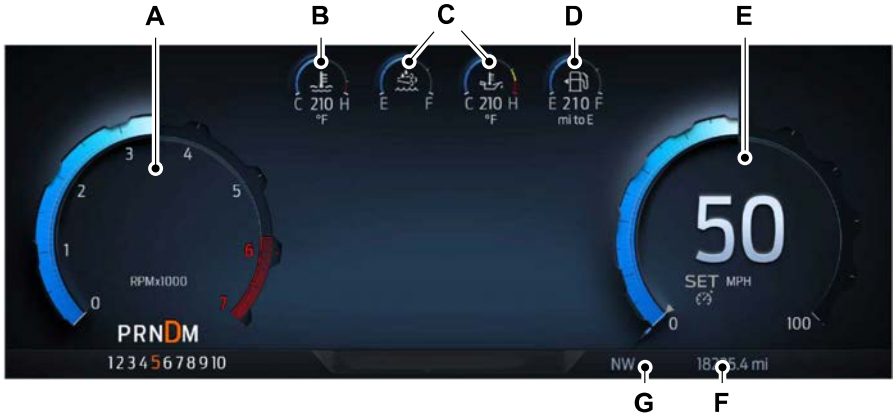

- A Tachometer.
- B Engine coolant temperature gauge.
- C Configurable gauges. Oil pressure, engine oil temperature, transmission fluid temperature, turbo boost or diesel exhaust fluid level.
- D Fuel gauge.
- E Speedometer.
- F Odometer.
- G Compass.

TACHOMETER

Indicates the engine speed.

SPEEDOMETER

Indicates the vehicle speed.

FUEL GAUGE

WHAT IS THE FUEL GAUGE

Indicates approximately how much fuel is in the fuel tank.

Instrument Cluster

FUEL GAUGE LIMITATIONS

The fuel gauge may not provide an accurate reading when your vehicle is on an incline.

LOCATING THE FUEL FILLER DOOR

The arrow adjacent to the fuel pump symbol indicates on which side of your vehicle the fuel filler door is located.

WHAT IS THE LOW FUEL REMINDER

A low fuel level reminder displays and sounds when the distance to empty reaches 80 km (50 mi), 40 km (25 mi), 20 km (10 mi) and 0 km (0 mi).

Note: *The low fuel reminder can appear at different fuel gauge positions depending on fuel economy conditions. This variation is normal.*

WHAT IS DISTANCE TO EMPTY

Indicates the approximate distance your vehicle can travel on the fuel remaining in the tank. Changes in driving pattern can cause the value to not only decrease but also increase or stay constant for periods of time.

Note: *When you have a trailer connected, your distance to empty accounts for the trailer.*

ENGINE COOLANT TEMPERATURE GAUGE

Indicates the engine coolant temperature.

ENGINE OIL PRESSURE GAUGE

Indicates the engine oil pressure.

Note: *This is a configurable gauge.*

ENGINE OIL TEMPERATURE GAUGE

Indicates the engine oil temperature.

Note: *This is a configurable gauge.*

TRANSMISSION FLUID TEMPERATURE GAUGE

Indicates the transmission fluid temperature.

Special operating conditions can cause higher than normal operating temperatures. See **General Maintenance Information** (page 589).

Note: *This is a configurable gauge.*

TURBO BOOST GAUGE

Indicates the amount of manifold air pressure in the engine.

Note: *This is a configurable gauge.*

DIESEL EXHAUST FLUID GAUGE

Indicates the current diesel exhaust fluid level.

Instrument Cluster Display

USING THE INSTRUMENT CLUSTER DISPLAY CONTROLS



WARNING: Driving while distracted can result in loss of vehicle control, crash and injury. We strongly recommend that you use extreme caution when using any device that may take your focus off the road. Your primary responsibility is the safe operation of your vehicle. We recommend against the use of any hand-held device while driving and encourage the use of voice-operated systems when possible. Make sure you are aware of all applicable local laws that may affect the use of electronic devices while driving.

The controls are on the steering wheel.

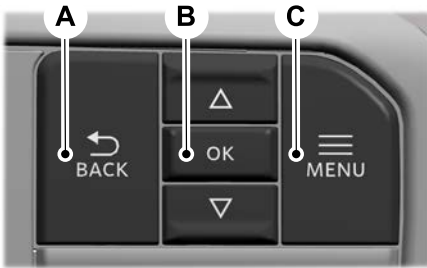

- A Back button.
- B OK button.
- C Menu button.

Back Button

Press to go back or to exit a menu.

OK Button

Press to make a selection.

Menu Button

Press to display the submenus.

Scroll Buttons

Press the up or down buttons to scroll through the menu items.

Status Indicator



Menu items with a check box indicates a feature's status. A check in the box indicates the feature is on, and unchecked indicates the feature is off.

INSTRUMENT CLUSTER DISPLAY MAIN MENU - VEHICLES WITH: 4.2 INCH SCREEN

Depending on your vehicle options, some menu items can appear different or not at all.

Note: For your safety, some features are speed-dependent and could be unavailable when your vehicle is above a certain speed.

Menu Item
Select Screens
Truck Info
Towing
Vehicle Maintenance
Settings

Instrument Cluster Display

INSTRUMENT CLUSTER DISPLAY MAIN MENU - VEHICLES WITH: 12 INCH SCREEN

Depending on your vehicle options, some menu items can appear different or not at all.

Note: For your safety, some features are speed-dependent and could be unavailable when your vehicle is above a certain speed.

Menu Item
MyView
Trip/Fuel
HUD
Gauges
Off Road
Towing
Status/Information
Navigation
Phone
Audio
Vehicle Maintenance
Settings

CUSTOMIZING THE INSTRUMENT CLUSTER DISPLAY - VEHICLES WITH: 4.2 INCH SCREEN

Adding Screens Using Select Screens

1. Select **Select Screens**.

2. Use the controls on the steering wheel to highlight a screen to add.
3. Press the **OK** button.

Note: The number of screens you can add is limited. If the selected screen does not appear you must deselect screens from the **Select Screens** menu.

Configuring Gauges

1. Select **Settings** using the instrument cluster display controls.
2. Select **Gauge Selection**.
3. Select to swap or change left-hand side and right-hand side gauges.

CUSTOMIZING THE INSTRUMENT CLUSTER DISPLAY - VEHICLES WITH: 12 INCH SCREEN

Adding Screens Using MyView

1. Using the instrument cluster display controls on the steering wheel, select **MyView**.
2. Select **Configure MyView**.
3. Select a screen.
4. Press the **OK** button.

Note: The number of screens you can add is limited. If the selected screen does not appear you must deselect screens from the **MyView** menu.

Configuring Gauges

1. Select **Settings**.
2. Select **Configure Gauges**.
3. Select to swap or change left-hand side and right-hand side gauges.

Trip Computer

ACCESSING THE TRIP COMPUTER - VEHICLES WITH: 4.2 INCH SCREEN

Note: *Trip 1 and 2 are selectable screens. See **Accessing the Trip Computer** (page 134). See **Accessing the Trip Computer** (page 134).*

Using Select Screens

1. Select **Select Screens**.
2. Use the controls on the steering wheel to navigate the menu. See **Customizing the Instrument Cluster Display** (page 133). or See **Customizing the Instrument Cluster Display** (page 133).

Using the Home Screen

After screens have been added, use the controls on the steering wheel to view each trip screen.

ACCESSING THE TRIP COMPUTER - VEHICLES WITH: 12 INCH SCREEN

1. Select Trip/Fuel.
2. Select Trip 1 or Trip 2.

RESETTING THE TRIP COMPUTER

1. Use the instrument cluster display controls to navigate the home screen.
2. Select the trip screen you want to reset.
3. Press and hold the **OK** button until the system reset confirmation appears.

TRIP DATA

Trip 1 and 2

Provides trip timer, trip average fuel economy and total trip distance traveled.

Head Up Display (If Equipped)

WHAT IS THE HEAD UP DISPLAY

The system displays information on a display screen in your field of vision, allowing you to keep your eyes on the road. You can select which information the system displays.

SWITCHING THE HEAD UP DISPLAY ON AND OFF

1. Using the instrument cluster display controls on the steering wheel, select HUD.
2. Switch **Head-Up Display (HUD)** on or off.

Note: The system remembers the last setting when you start your vehicle.

HEAD UP DISPLAY SETTINGS

1. Using the instrument cluster display controls on the steering wheel, select HUD.

Note: If **HUD On** is unchecked, other options of the system are hidden.

You can adjust the following settings in the HUD menu:

- Brightness.
- Vertical position.
- Image rotation.
- Content.
- Drive mode layout.

Note: The head up display menu automatically closes after a certain period of inactivity.

Note: The head up display image brightness automatically adjusts to the brightness of the ambient environment. You have the ability to adjust the brightness further according to your preference.

Note: In some instances, sunlight can cause some reflections in and around the head up display image.

Note: When you save a memory preset position, your current HUD settings are also saved to that memory preset position. See **Memory Function** (page 164).

Head Up Display (If Equipped)

HEAD UP DISPLAY – TROUBLESHOOTING

HEAD UP DISPLAY – INFORMATION MESSAGES

Message	Action
Head Up Display System Fault See Manual	The system is malfunctioning or something is obstructing the display. Make sure that the head up display is free from obstruction. If the message continues to appear, have your vehicle checked as soon as possible.
Head Up Display To Position Use the Information Display	Press the button on the steering wheel or center console. The head up display menu appears in the instrument cluster display. Make sure the blue frame is fully visible. Do not manually move the screen. This can cause damage not covered by your vehicle's warranty.

Remote Start (If Equipped)

USING REMOTE START





WARNING: Do not start the engine in a closed garage or in other enclosed areas. Exhaust fumes are toxic. Always open the garage door before you start the engine. Failure to follow this instruction could result in personal injury or death.



WARNING: Do not keep electrical devices plugged in the power outlet whenever the device is not in use. Power outlets power up during remote start.

The system allows you to remotely start your vehicle to heat or cool the interior to a preset temperature.

-  Press the button on the remote control.
-  Press the button twice within a few seconds.

When you successfully remote start your vehicle:

- The vehicle doors lock.
- The turn signal lamps flash twice.
- The parking lamps turn on when the vehicle is running.
- The vehicle remains secured when you have remotely started the vehicle. A valid key must be inside your vehicle to switch your vehicle on and drive your vehicle.
- All other vehicle systems remain off when you have remotely started the vehicle.

The horn sounds if the system fails to start.

Note: You cannot adjust any comfort settings until you switch your vehicle on from inside your vehicle.

Remote start does not work under the following conditions:

- Remote start is not enabled.
- The alarm horn is sounding.
- The hood is open.
- The transmission is not in park (P).
- Your vehicle is already on.

Note: Do not use remote start if your fuel level is low.

Note: A maximum of two remote starts are allowed. After that you have to switch your vehicle on and off before you can use remote start again.



To remotely stop your vehicle, press the button.

REMOTE START SETTINGS

1. From the settings menu, press Vehicle.
2. Press Remote Start Setup.

You can adjust the following in the remote start settings menu:

- Enable or disable remote start.
- Climate control settings.
- Heated seat settings.
- Heated steering wheel settings.
- Remote start duration.

Climate Control - Vehicles With: Automatic Temperature Control

IDENTIFYING THE CLIMATE CONTROL UNIT



Depending on your vehicle options, the controls could look different than what you see here.

SWITCHING CLIMATE CONTROL ON AND OFF



Press the button.

SWITCHING RECIRCULATED AIR ON AND OFF



Press the button to recirculate air currently in the passenger compartment.

Note: *Recirculated air may turn off automatically, or prevent you from switching on in all air flow modes except MAX A/C to reduce the risk of fogging. Recirculation may also turn on and off automatically in various air distribution control combinations to improve heating or cooling efficiency.*

SWITCHING AIR CONDITIONING ON AND OFF



Press the button.

Note: *Under certain conditions, the air conditioning compressor could continue to operate after you switch air conditioning off.*

Note: *To keep the system and its components fully functional, switch air conditioning on and let your vehicle idle at least once per month for a minimum of two minutes.*

SWITCHING DEFROST ON AND OFF



Press the button to activate the selection screen.



Press the button on the touchscreen to switch the windshield air vents on.



Make sure that the instrument panel air vents are switched off.



Make sure that the footwell air vents are switched off.

SWITCHING MAXIMUM DEFROST ON AND OFF



Press the button.

Air flows through the windshield air vents, and the blower motor adjusts to the highest speed.

You can also use this setting to defog and clear the windshield of a thin covering of ice.

Note: *To prevent window fogging, you cannot select recirculated air when maximum defrost is on.*

Note: *The heated rear window also turns on when you select maximum defrost.*

Note: *When maximum defrost is on, the air conditioning compressor may continue to operate even though you switch off the air conditioning.*

Climate Control - Vehicles With: Automatic Temperature Control

SWITCHING MAXIMUM COOLING ON AND OFF

 Press the button.

Note: When you switch maximum cooling off, air conditioning remains on.

SWITCHING THE HEATED REAR WINDOW ON AND OFF

 Press the button to clear the rear window of thin ice and fog. The heated rear window turns off after a short period of time.

Note: This button also activates the heated mirrors.

Note: Do not use harsh chemicals, razor blades or other sharp objects to clean or remove decals from the inside of the heated rear window as this could cause damage to the heated rear window grid lines not covered by the vehicle Warranty.

SETTING THE BLOWER MOTOR SPEED



Press up or down on the control to select the blower motor speed.

Note: For Hybrid Electric Vehicle (HEV) and Plug-In Hybrid Electric Vehicle (PHEV) vehicles, the blower motor may run, and you may feel airflow when the climate control is off, to provide cooling to the battery.

SWITCHING THE HEATED MIRRORS ON AND OFF

When you switch the heated rear window on, the heated exterior mirrors turn on. See **Switching the Heated Rear Window On and Off** (page 139).



You can also turn on and off the heated exterior mirrors using the mirror defrost button.

Note: Do not remove ice from the mirrors with a scraper or adjust the mirror glass when it is frozen in place.

Note: Do not clean the mirror housing or glass with harsh abrasives, fuel or other petroleum-based cleaning products. The vehicle warranty may not cover damage caused to the mirror housing or glass.

Note: The engine must be running or your vehicle must be ready to drive to switch the system on.

SETTING THE TEMPERATURE

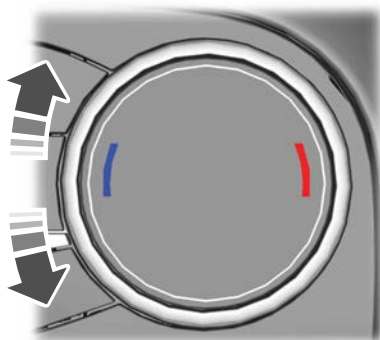

Turn the control on the left-hand side of the climate control to set the left-hand temperature.

Climate Control - Vehicles With: Automatic Temperature Control

Note: This control also sets the right-hand side temperature when you switch off dual zone mode.

Turn the control on the right-hand side of the climate control to set the right-hand temperature.

DIRECTING THE FLOW OF AIR

Directing Air to the Windshield Air Vents



Press the button to activate the selection screen.



Press the button on the touchscreen.

Directing Air to the Instrument Panel Air Vents



Press the button to activate the selection screen.



Press the button on the touchscreen.

Directing Air to the Footwell Air Vents



Press the button to activate the selection screen.



Press the button on the touchscreen.

AUTO MODE

SWITCHING AUTO MODE ON AND OFF



Press the button to switch auto mode on. Repeatedly press the button to adjust auto mode.

Note: When you switch auto mode on, lights on the blower motor control do not illuminate to indicate the blower motor speed.

Adjust the blower motor control or air distribution control to switch auto mode off.

SWITCHING DUAL MODE ON AND OFF



Press the button.

CLIMATE CONTROL HINTS

General Hints

- Prolonged use of recirculated air may cause the windows to fog up.
- You may feel a small amount of air from the footwell air vents regardless of the air distribution setting.
- To reduce humidity build-up inside your vehicle, do not drive with the system switched off or with recirculated air always switched on.
- Do not place objects under the front seats as this may interfere with the airflow to the rear seats.
- Remove any snow, ice or leaves from the air intake area at the base of the windshield.
- To improve the time to reach a comfortable temperature in hot weather, drive with the windows open until you feel cold air through the air vents.

Climate Control - Vehicles With: Automatic Temperature Control

Automatic Climate Control

- Adjusting the settings when your vehicle interior is extremely hot or cold is not necessary. Automatic mode is best recommended to maintain set temperature.
- The system adjusts to heat or cool the interior to the temperature you select as quickly as possible.
- For the system to function efficiently, the instrument panel and side air vents should be fully open.
- If you press **AUTO** during cold outside temperatures, the system directs air flow to the windshield and side window air vents. In addition, the blower motor may run at a slower speed until the engine warms up.
- If you press **AUTO** during hot temperatures and the inside of the vehicle is hot, the system uses recirculated air to maximize interior cooling. Blower motor speed may also reduce until the air cools.

Quickly Heating the Interior

1. Press **AUTO**.
2. Adjust the temperature function to the setting you prefer.

Recommended Settings for Heating

1. Press **AUTO**.
2. Adjust the temperature function to the setting you prefer. Use 22°C (72°F) as a starting point, then adjust the setting as necessary.

Quickly Cooling the Interior

1. Press **MAX A/C**.
2. Drive with the windows open for a short period of time.

Recommended Settings for Cooling

1. Press **AUTO**.
2. Adjust the temperature function to the setting you prefer. Use 22°C (72°F) as a starting point, then adjust the setting as necessary.

Defogging the Side Windows in Cold Weather

1. Press and release defrost or maximum defrost.
2. Adjust the temperature control to the setting you prefer. Use 22°C (72°F) as a starting point, then adjust the setting as necessary.

CLIMATE CONTROL VIDEOS

[Heated Mirrors](#)

AIR CONDITIONING SYSTEM REFRIGERANT



WARNING: The air conditioning refrigerant system contains refrigerant under high pressure. Only qualified personnel should service the air conditioning refrigerant system. Opening the air conditioning refrigerant system can cause personal injury.

Your vehicle has an under hood label that identifies the refrigerant used by the air conditioning system.

Note: Only allow a trained and certified technician service the refrigerant system to ensure proper and safe operation, per the society of automotive engineers J2845.

Climate Control - Vehicles With: Automatic Temperature Control

Note: *Never repair or replace the air conditioning evaporator with one from a salvage vehicle. Only replace it with a new evaporator to ensure proper and safe operation.*

The meaning of each symbol on the under hood label are as follows:



Caution



Air conditioning system.



System lubricant type.



See vehicle service manual for service information.



Requires registered technician to service.



Flammable refrigerant.



Replace safety system components. Do not repair, reuse or try to salvage.

Climate Control - Vehicles With: Manual Temperature Control

IDENTIFYING THE CLIMATE CONTROL UNIT



Depending on your vehicle options, the controls could look different than what you see here.

SWITCHING CLIMATE CONTROL ON AND OFF



Press the button.

SWITCHING RECIRCULATED AIR ON AND OFF



Press the button to recirculate air currently in the passenger compartment.

Note: Recirculated air may turn off automatically, or prevent you from switching on in all air flow modes except MAX A/C to reduce the risk of fogging. Recirculation may also turn on and off automatically in various air distribution control combinations to improve heating or cooling efficiency.

SWITCHING AIR CONDITIONING ON AND OFF



Press the button.

Note: Under certain conditions, the air conditioning compressor could continue to operate after you switch air conditioning off.

Note: To keep the system and its components fully functional, switch air conditioning on and let your vehicle idle at least once per month for a minimum of two minutes.

SWITCHING DEFROST ON AND OFF



Press the button to switch the windshield air vents on.



Make sure that the instrument panel air vents are switched off.



Make sure that the footwell air vents are switched off.

SWITCHING MAXIMUM DEFROST ON AND OFF



Turn the temperature control clockwise past the highest setting to maximize defrosting.

Note: The temperature control springs back to the highest setting.

Air flows through the windshield air vents, and the blower motor adjusts to the highest speed.

Note: To prevent window fogging, you cannot select recirculated air when maximum defrost is on.

Note: The heated rear window also turns on when you select maximum defrost.

Climate Control - Vehicles With: Manual Temperature Control

SWITCHING MAXIMUM COOLING ON AND OFF

MAX A/C Turn the temperature control counterclockwise past the lowest setting to maximize cooling.

Note: The temperature control springs back to the lowest setting.

Note: When you switch maximum cooling off, air conditioning remains on.

SWITCHING THE HEATED REAR WINDOW ON AND OFF (IF EQUIPPED)

REAR Press the button to clear the rear window of thin ice and fog. The heated rear window turns off after a short period of time.

Note: Do not use harsh chemicals, razor blades or other sharp objects to clean or remove decals from the inside of the heated rear window as this could cause damage to the heated rear window grid lines not covered by the vehicle Warranty.

SETTING THE BLOWER MOTOR SPEED

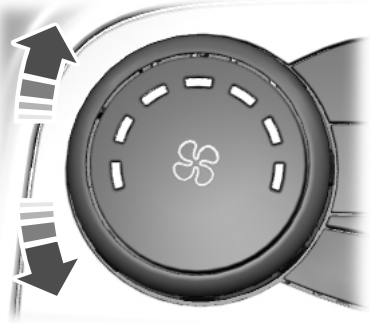

Turn the blower motor control counterclockwise for a lower blower setting.

Turn the blower motor control clockwise for a higher blower setting.

Note: Lights on the control illuminate to indicate the blower motor speed.

Note: When you switch the blower motor off, air conditioning turns off and the windows could fog up.

SWITCHING THE HEATED MIRRORS ON AND OFF

When you switch the heated rear window on, the heated exterior mirrors turn on.

See **Switching the Heated Rear Window On and Off** (page 139).

MIRROR You can also turn on and off the heated exterior mirrors using the mirror defrost button.

Note: Do not remove ice from the mirrors with a scraper or adjust the mirror glass when it is frozen in place.

Climate Control - Vehicles With: Manual Temperature Control

Note: Do not clean the mirror housing or glass with harsh abrasives, fuel or other petroleum-based cleaning products. The vehicle warranty may not cover damage caused to the mirror housing or glass.

Note: The engine must be running or your vehicle must be ready to drive to switch the system on.

SETTING THE TEMPERATURE

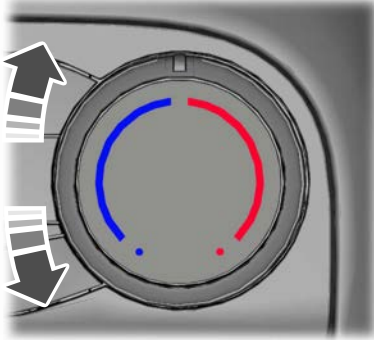

Turn the temperature control counterclockwise for cooler temperature settings.

Turn the temperature control clockwise for warmer temperature settings.

DIRECTING THE FLOW OF AIR

Directing Air to the Windshield Air Vents



Press the button.

Directing Air to the Instrument Panel Air Vents



Press the button.

Directing Air to the Footwell Air Vents



Press the button.

CLIMATE CONTROL HINTS

General Hints

- Prolonged use of recirculated air may cause the windows to fog up.
- You may feel a small amount of air from the footwell air vents regardless of the air distribution setting.
- To reduce humidity build-up inside your vehicle, do not drive with the system switched off or with recirculated air always switched on.
- Do not place objects under the front seats as this may interfere with the airflow to the rear seats.
- Remove any snow, ice or leaves from the air intake area at the base of the windshield.
- To improve the time to reach a comfortable temperature in hot weather, drive with the windows open until you feel cold air through the air vents.

Quickly Heating the Interior

1. Adjust the blower motor speed to the highest speed setting.
2. Adjust the temperature control to the highest setting.
3. Direct air to the footwell air vents.

Climate Control - Vehicles With: Manual Temperature Control

Recommended Settings for Heating

1. Adjust the blower motor speed to the center setting.
2. Adjust the temperature control to the midway point of the hot settings.
3. Direct air to the footwell air vents.

Quickly Cooling the Interior

1. Turn the temperature control counterclockwise past the lowest setting.
2. Drive with the windows open for a short period of time.

Recommended Settings for Cooling

1. Adjust the blower motor speed to the center setting.
2. Adjust the temperature control to the midway point of the cold settings.
3. Direct air to the instrument panel air vents.

Defogging the Side Windows in Cold Weather

1. Direct air to the instrument panel and windshield air vents.
2. Press and release **A/C**.
3. Adjust the temperature control to the setting you prefer.
4. Adjust the blower motor speed to the highest setting.
5. Direct air toward the side windows.
6. Close the instrument panel air vents.

CLIMATE CONTROL VIDEOS

[*Heated Mirrors*](#)

Interior Air Quality

WHAT IS THE CABIN AIR FILTER

The cabin air filter improves the quality of air in your vehicle by trapping dust, pollen and other particles.

REPLACING THE CABIN AIR FILTER

Replace the filter at regular intervals.

The cabin air filter is behind the glove compartment.

To remove the lower glove compartment and access the filter:

1. Open the glove compartment.

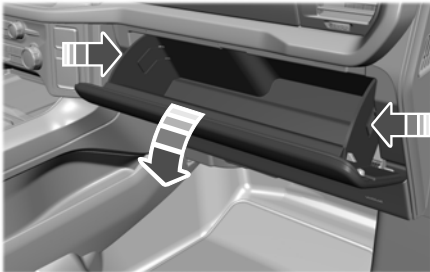

2. Press the tab on each side.
3. Fully lower the glove compartment.
4. Pull the glove compartment toward you.
5. Unclip both sides of the filter door and swing door down to access filter .

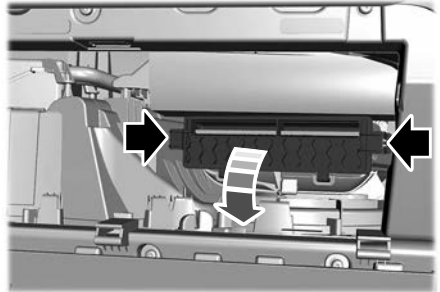

6. Remove the old filter and replace with a new filter.

Front Seats

FRONT SEAT PRECAUTIONS



WARNING: Sitting improperly, out of position or with the seatback reclined too far can take weight off the seat cushion and affect the decision of the passenger sensing system, resulting in serious injury or death in the event of a crash. Always sit upright against your seat back, with your feet on the floor.



WARNING: Do not recline the seat backrest too far as this can cause the occupant to slide under the seatbelt, resulting in personal injury in the event of a crash.



WARNING: Do not place objects higher than the top of the seat backrest. Failure to follow this instruction could result in personal injury or death in the event of a sudden stop or crash.



WARNING: Do not adjust the driver seat or seat backrest when your vehicle is moving. This may result in sudden seat movement, causing the loss of control of your vehicle.

SITTING IN THE CORRECT POSITION

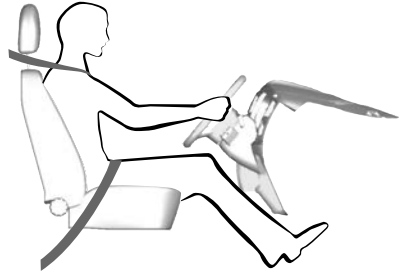

When you use them properly, the seat, head restraint, seatbelt and airbags will provide optimum protection in the event of a crash.

We recommend that you follow these guidelines:

- Sit in an upright position with the base of your spine as far back as possible.
- Do not recline the seat backrest so that your torso is more than 30 degrees from the upright position.
- Adjust the head restraint so that the top of it is level with the top of your head and as far forward as possible. Make sure that you remain comfortable.
- Keep sufficient distance between yourself and the steering wheel. We recommend a minimum of 25 cm (10 in) between your breastbone and the airbag cover.
- Hold the steering wheel with your arms slightly bent.

Front Seats

- Bend your legs slightly so that you can press the pedals fully.
- Position the shoulder strap of the seatbelt over the center of your shoulder and position the lap strap tightly across your hips.

Make sure that your driving position is comfortable and that you can maintain full control of your vehicle.

MANUAL SEATS

HEADRESTRAINT COMPONENTS

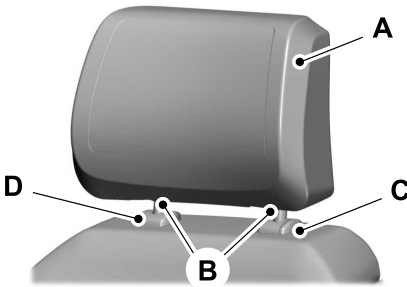

The head restraints consist of:

- A An energy absorbing head restraint.
- B Two steel stems.
- C Guide sleeve adjust and release button.
- D Guide sleeve unlock and remove button - if equipped.

Center Head Restraint - If Equipped

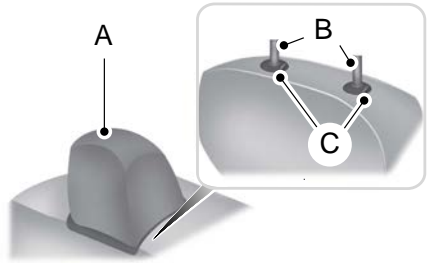

- A An energy absorbing head restraint.
- B Two steel stems.
- C Guide sleeve unlock and remove buttons.

ADJUSTING THE HEAD RESTRAINT

⚠ WARNING: Fully adjust the head restraint before you sit in or operate your vehicle. This will help minimize the risk of neck injury in the event of a crash. Do not adjust the head restraint when your vehicle is moving.

⚠ WARNING: The head restraint is a safety device. Whenever possible it should be installed and properly adjusted when the seat is occupied. Failure to adjust the head restraint properly could reduce its effectiveness during certain impacts.

⚠ WARNING: Adjust the head restraints for all passengers before you drive your vehicle. This will help minimize the risk of neck injury in the event of a crash. Do not adjust the head restraints when your vehicle is moving.

Front Seats

Note: Adjust the seat backrest to an upright driving position before adjusting the head restraint. Adjust the head restraint so that the top of it is level with the top of your head and as far forward as possible. Make sure that you remain comfortable. If you are extremely tall, adjust the head restraint to its highest position.

Pull the head restraint up to raise it.

To lower the head restraint:

1. Press and hold the adjust and release button.
2. Push the head restraint down.



For vehicles with tilting head restraints:

1. Adjust the seat backrest to an upright driving or riding position.
2. Pivot the head restraint forward toward your head to the preferred position.

After the head restraint reaches the forward-most tilt position, pivot it forward again to release it to the rearward, untilted position.

Note: Do not attempt to force the head restraint backward after it is tilted. Instead, continue tilting it forward until the head restraint releases to the upright position.

REMOVING THE HEAD RESTRAINT

1. Pull up the head restraint until it reaches the highest adjustment position.
2. Press and hold the adjust and release button and the unlock and remove button.
3. Pull up the head restraint.

Note: Your vehicle may have a front row center head restraint that you cannot adjust or remove.

INSTALLING THE HEAD RESTRAINT

Align the steel stems into the guide sleeves and push the head restraint down until it locks.

MOVING THE SEAT BACKWARD AND FORWARD



WARNING: Do not adjust the driver seat or seat backrest when your vehicle is moving. This may result in sudden seat movement, causing the loss of control of your vehicle.



WARNING: Make sure the seat fully locks into place by rocking it backward and forward. Not securing the seat into the locked position can be dangerous in a crash and could cause serious personal injury or death.

Front Seats



ADJUSTING THE LUMBAR SUPPORT

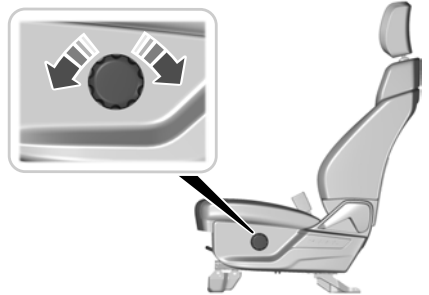

ADJUSTING THE SEAT BACKREST

WARNING: Always drive and ride with your seatback upright and the lap belt snug and low across the hips.

WARNING: Do not place cargo or any objects behind the seat backrest before returning it to the original position. Pull on the seat backrest to make sure that it has fully latched after returning the seat backrest to its original position. An unlatched seat may become dangerous if you stop suddenly or have a crash.



POWER SEATS (IF EQUIPPED)

HEADRESTRAINT COMPONENTS

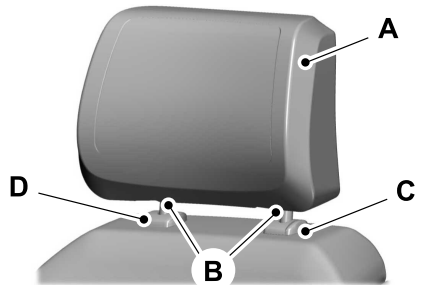

The head restraints consist of:

- A An energy absorbing head restraint.
- B Two steel stems.
- C Guide sleeve adjust and release button.
- D Guide sleeve unlock and remove button.

Front Seats

Center Head Restraint - If Equipped

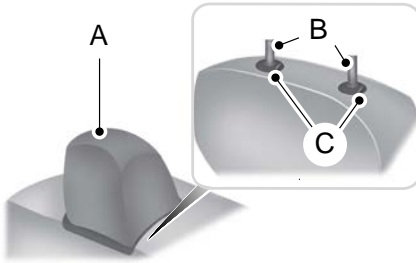

- A An energy absorbing head restraint.
- B Two steel stems.
- C Guide sleeve unlock and remove buttons.

ADJUSTING THE HEAD RESTRAINT



WARNING: Fully adjust the head restraint before you sit in or operate your vehicle. This will help minimize the risk of neck injury in the event of a crash. Do not adjust the head restraint when your vehicle is moving.



WARNING: The head restraint is a safety device. Whenever possible it should be installed and properly adjusted when the seat is occupied. Failure to adjust the head restraint properly could reduce its effectiveness during certain impacts.



WARNING: Adjust the head restraints for all passengers before you drive your vehicle. This will help minimize the risk of neck injury in the event of a crash. Do not adjust the head restraints when your vehicle is moving.

To raise the head restraint, pull the head restraint up.

To lower the head restraint:

1. Press and hold the adjust and release button.
2. Push the head restraint down.

To tilt the head restraint:



1. Adjust the seat backrest to an upright driving or riding position.
2. Pivot the head restraint forward toward your head to the preferred position.

After the head restraint reaches the forward-most tilt position, pivot it forward again to release it to the rearward, untilted position.

Note: Do not attempt to force the head restraint backward after it is tilted. Instead, continue tilting it forward until the head restraint releases to the upright position.

REMOVING THE HEADRESTRAINT

1. Pull up the head restraint until it reaches its highest position.
2. Press and hold the adjust and release button and the unlock and remove button.
3. Pull up the head restraint.

Front Seats

Note: Your vehicle may have a front row center head restraint that you cannot adjust or remove.

INSTALLING THE HEAD RESTRAINT

Align the steel stems into the guide sleeves and push the head restraint down until it locks.

MOVING THE SEAT BACKWARD AND FORWARD

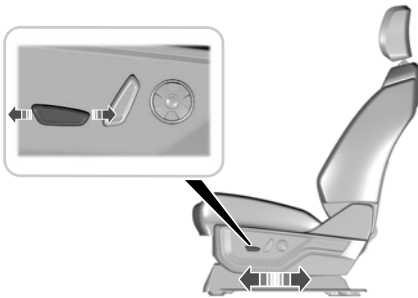

ADJUSTING THE SEAT BACKREST

WARNING: Always drive and ride with your seatback upright and the lap belt snug and low across the hips.

WARNING: Do not place cargo or any objects behind the seatback before returning it to the original position.

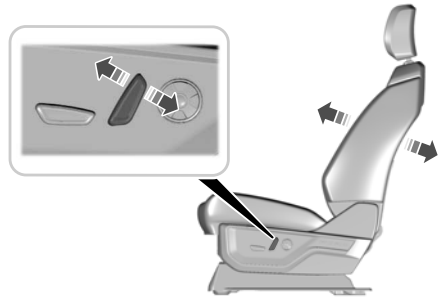

Adjusting the Seat Flat (If Equipped)

ADJUSTING THE SEAT CUSHION

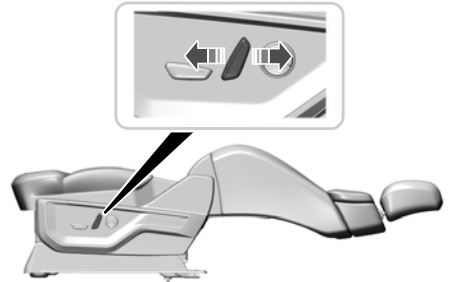
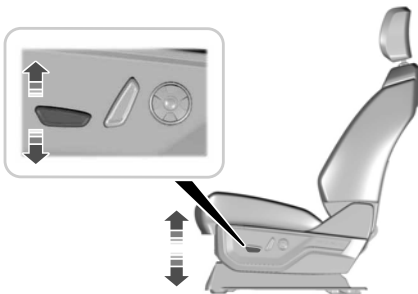

This feature allows the occupant to find a comfortable position to rest when the vehicle is not moving.

Front Seats

Note: Before adjusting the seat backrest fully flat, place the rear seat cushion into the upright position and remove any objects that could obstruct the movement of the flat seat. See **Folding the Seats** (page 158).

As the seat folds flat, the cushion adjusts to support the hips and lower back. For additional support, you can also adjust the upper seat backrest.

If you fully recline the passenger seat and the vehicle is moving, a message appears on the instrument cluster and a tone sounds. To switch the warning off, return the seat to an upright position.

Adjusting the Upper Seat Backrest (If Equipped)

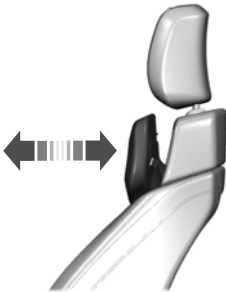

The front upper seat backrest tilts for extra comfort. To tilt the upper seat backrest, pivot the upper seat backrest toward your shoulders.

After the upper seat backrest reaches the forward-most tilt position, pivot it forward again to release it to the rearward, untilted position.

ADJUSTING THE SEAT HEIGHT



E390743

ADJUSTING THE LUMBAR SUPPORT

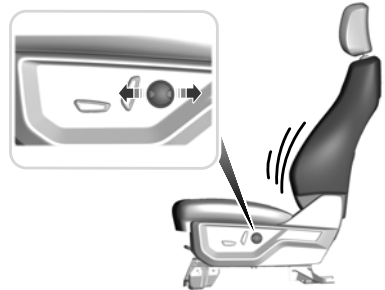

MASSAGE SEATS (IF EQUIPPED)

MASSAGE SEAT LIMITATIONS

Your vehicle must be running or be in accessory mode to activate the seats.

Allow a few seconds for any selection to activate. Selecting a different adjustment cancels the current one in progress. When the seat backrest and cushion are both active, the massage alternates between zones.

Front Seats

ADJUSTING THE MASSAGE SEAT SETTINGS

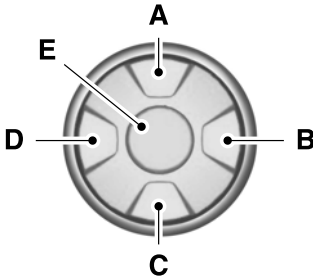

- A Select the previous massage pattern or lumbar area.
- B Decrease the massage or lumbar Intensity.
- C Select the next massage pattern or lumbar area.
- D Increase the massage or lumbar Intensity.
- E Select the massage or lumbar mode.

You can also adjust this feature through the touchscreen.

HEATED SEATS (IF EQUIPPED)

HEATED SEAT PRECAUTIONS

WARNING: Use caution when using the heated seat if you are unable to feel pain to your skin because of advanced age, chronic illness, diabetes, spinal cord injury, medication, alcohol use, exhaustion or other physical conditions. The heated seat could cause burns even at low temperatures, especially if used for long periods of time. Failure to follow this instruction could result in personal injury.

WARNING: Do not poke sharp objects into the seat cushion or seat backrest. This could damage the heated seat element and cause it to overheat. Failure to follow this instruction could result in personal injury.

WARNING: Do not place anything on the seat that blocks the heat, for example a seat cover or a cushion. This could cause the seat to overheat. Failure to follow this instruction could result in personal injury.

Do not:

- Place heavy objects on the seat.
- Operate the heated seat if water or any other liquid spills on the seat. Allow the seat to dry.

SWITCHING THE HEATED SEATS ON AND OFF

The vehicle must be running to use this feature.

Front Seats



Press the heated seat symbol on the climate controls or touchscreen to cycle through the various heat settings and off. The more indicators that display, the warmer the temperature of the seat.

Note: *The heated seats may remain on after you remote start your vehicle, based on your remote start settings. The heated seats may also turn on when you start your vehicle if they were on when you switched your vehicle off.*

VENTILATED SEATS (IF EQUIPPED)

VENTILATED SEAT PRECAUTIONS

Do not:

- Spill liquid on the front seats. This may cause the air vent holes to become blocked and not work properly.
- Place cargo or objects under the seats. They may block the air intake causing the air vents to not work properly.

SWITCHING THE VENTILATED SEATS ON AND OFF

The vehicle must be running to use this feature.



Press this symbol on the climate controls or the touchscreen to cycle through the various ventilation settings and off. More indicator lights indicate higher fan speeds.

Note: *When you switch the climate control fan speed and the ventilated seats to their maximum settings, the ventilated seats provide increased cooling.*

If the engine falls below 350 RPM while the ventilated seats are on, the feature turns itself off unless the vehicle is in Auto-Start-Stop mode. You may need to reactivate the ventilated seats.

Note: *The ventilated seats may remain on after you remote start your vehicle, based on your remote start settings. The ventilated seats may also turn on when you start your vehicle if they were on when you switched your vehicle off.*

Rear Seats - Crew Cab/SuperCab

MANUAL SEATS

HEADRESTRAINT COMPONENTS

Outermost Head Restraints

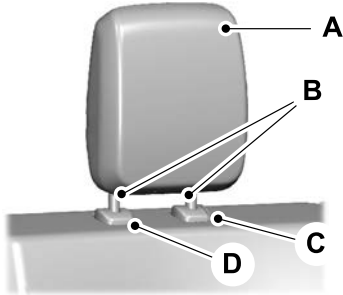

The head restraints consist of:

- A An energy absorbing head restraint.
- B Two steel stems.
- C Guide sleeve adjust and release button.
- D Guide sleeve unlock and remove button.

Center Head Restraint - Crew Cab and Super Cab

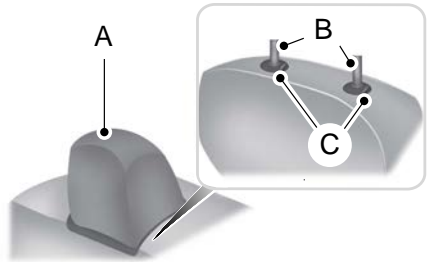

- A An energy absorbing head restraint.
- B Two steel stems.
- C Guide sleeve unlock and remove buttons.

ADJUSTING THE HEAD RESTRAINT

Pull the head restraint up to raise it.

To lower the head restraint:

1. Press and hold the adjust and release button.
2. Push the head restraint down.

Your vehicle may have a rear seat center head restraint that you cannot adjust or remove.

REMOVING THE HEADRESTRAINT

1. Pull up the head restraint until it reaches its highest position.
2. Press and hold the adjust and release button and the unlock and remove button.
3. Pull up the head restraint.

Rear Seats - Crew Cab/SuperCab

INSTALLING THE HEAD RESTRAINT

Align the steel stems into the guide sleeves and push the head restraint down until it locks.

FOLDING THE SEATS

If your vehicle has a split folding rear seat, you can flip each seat cushion up into a vertical storage position.



Rotate the seat cushion up until it locks in place.

Locking the Cushion (If Equipped)

The locking key is in the remote control. See **Using the Remote Control** (page 67).

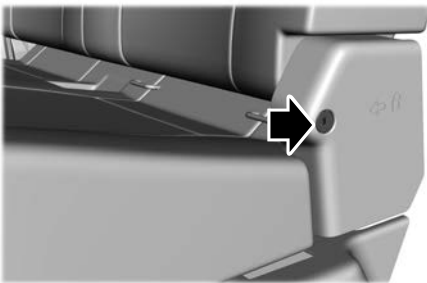

Turn the key to lock or unlock.

UNFOLDING THE SEATS



WARNING: Make sure that cargo and other objects are not trapped under the seat cushion and that you return the seat cushion to the full-down position. Failure to do so may prevent the seat from operating properly, which could increase the risk of serious injury in a crash.

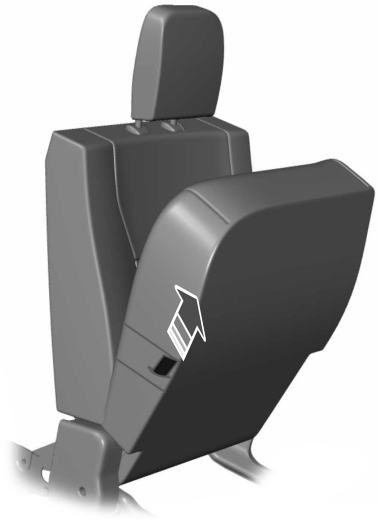

Pull the strap to lower the seat cushion.

Rear Under Seat Storage (If Equipped)

The rear seat has storage space under the seat cushion.

Rear Seats - Crew Cab/SuperCab

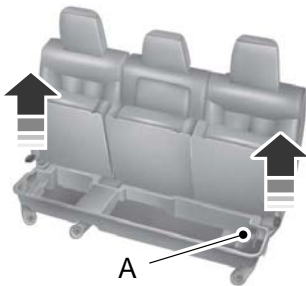

Lift the lever and flip up the seat cushion to access the storage space and the power point (A).

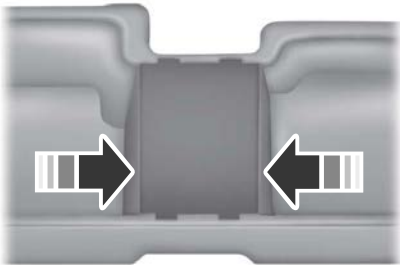

To remove the storage space divider, squeeze the sides and lift it from the storage tub.



Use your vehicle key to lock the storage space. See **Keys and Remote Controls** (page 67).

HEATED SEATS (IF EQUIPPED)

HEATED SEAT PRECAUTIONS

WARNING: Use caution when using the heated seat if you are unable to feel pain to your skin because of advanced age, chronic illness, diabetes, spinal cord injury, medication, alcohol use, exhaustion or other physical conditions. The heated seat could cause burns even at low temperatures, especially if used for long periods of time. Failure to follow this instruction could result in personal injury.

WARNING: Do not poke sharp objects into the seat cushion or seat backrest. This could damage the heated seat element and cause it to overheat. Failure to follow this instruction could result in personal injury.

WARNING: Do not place anything on the seat that blocks the heat, for example a seat cover or a cushion. This could cause the seat to overheat. Failure to follow this instruction could result in personal injury.

Do not:

- Place heavy objects on the seat.
- Operate the heated seat if water or any other liquid spills on the seat. Allow the seat to dry.

Rear Seats - Crew Cab/SuperCab

SWITCHING THE HEATED SEATS ON AND OFF

The vehicle must be running to use this feature.

The rear seat heat controls are on the rear of the center console.



Press the heated seat symbol to cycle through the various heat settings and off. More indicator lights indicate warmer settings.

The heated seats turn off when you switch off the vehicle.

Rear Occupant Alert System - Crew Cab/SuperCab

WHAT IS THE REAR OCCUPANT ALERT SYSTEM

The rear occupant alert system monitors vehicle conditions and notifies you to check for rear seat occupants when you switch the ignition off. The notifications can be in the form of warnings inside the vehicle and sounding of the horn if activated for a short period of time.

HOW DOES THE REAR OCCUPANT ALERT SYSTEM WORK

The system monitors the activity of the buckle on the rear seatbelt and the opening and closing of the rear doors to indicate the potential presence of an occupant in the rear seat.

When **Child Seat Installed** is selected, the system monitors only the opening and closing of the rear doors to indicate the potential presence of an occupant in the rear seat.

When **Child Seat Installed** is not selected, the system monitors the rear seatbelt buckle activity and the opening and closing of the rear doors to indicate the potential presence of an occupant in the rear seat.

A message displays in the touchscreen and an audible warning sounds when you switch the ignition off after any of the following conditions have been met:

- A rear door is opened or closed while the ignition is on.
- You switch the ignition on within 15 minutes of a rear door opening and closing.
- You switch the ignition on within 15 minutes of the alert having displayed or sounded.

If you do not open a rear door within a short period of time of the message appearing in the center display, the first audible warning sounding and driver door open to close, the horn sounds for a short period of time.

Note: *Horn sounds only when the **Rear Occupant Alert** is set to **Alert & Horn**. If you change the setting, then there is no horn sound.*

REAR OCCUPANT ALERT SYSTEM PRECAUTIONS

 **WARNING:** On hot days, the temperature inside the vehicle can rise very quickly. Exposure of people or animals to these high temperatures for even a short time can cause death or serious heat related injuries, including brain damage. Small children are particularly at risk.

 **WARNING:** Do not leave children or pets unattended in your vehicle. Failure to follow this instruction could result in personal injury or death.

REAR OCCUPANT ALERT SYSTEM LIMITATIONS

The system does not detect the presence of objects or passengers in the rear seat. It monitors the activity of the buckle on the rear seatbelt and the opening and closing of the rear doors.

Note: *It is possible to receive an alert when there is no rear seat occupant, but alert conditions are met.*

Rear Occupant Alert System - Crew Cab/SuperCab

Note: It is possible to receive no alert when there is an occupant in the rear seat, if alert conditions are not met. For example, if a rear seat occupant does not enter the vehicle through a rear door.

REAR OCCUPANT ALERT SYSTEM SETTINGS

1. From the settings menu, press Vehicle. See **Center Display** (page 558).
2. Press Rear Occupant Alert.
3. Select Alert & Horn or Alert Only or Off.

Note: The default setting is Alert Only.

Note: If you choose Alert only, the horn does not sound even when the alert conditions are met.

Note: Performing a system reset causes the system to switch on again.

Switching Child Seat Installed On and Off

When the system is switched on, it monitors the opening and closing of the rear doors to indicate the potential presence of an occupant in the rear seat.

1. From the settings menu, press Vehicle. See **Center Display** (page 558).
2. Press Rear Occupant Alert.
3. Switch Child Seat Installed on or off.

Note: The default setting is on.

Switch the system on when the child restraint is mounted on any of the following:

- Forward facing seat.
- Rear facing seat.
- Toddler in a LATCH system child seat.

Switch the system off when the child is using any of the following:

- Seatbelt.
- Booster seat.

Semiannual Reminder

When you switch the system off, a message appears every six months as a reminder that the system is off. You can switch the system back on or leave it off.

REAR OCCUPANT ALERT SYSTEM INDICATORS



Message
Check rear seats for occupants.

Displays when you switch your vehicle off after the alert conditions are met.

The message displays for a short period of time. Press **Close** to acknowledge and remove the message.

Note: The graphic may be different for your vehicle.

Rear Occupant Alert System - Crew Cab/SuperCab

REAR OCCUPANT ALERT SYSTEM AUDIBLE WARNINGS

The first audible warning is an alert tone within the vehicle, which sounds when you switch your vehicle off after the alert conditions are met. The warning sounds for a short period of time.

The second audible warning is from the horn. It sounds when you do not open a rear door within a short period of time of the message appearing in the center display, the first audible warning sounding, and driver door open to close. The warning sounds for a short period of time.

Memory Function (If Equipped)

WHAT IS THE MEMORY FUNCTION

The memory function recalls the position of these features:

- Driver seat.
- Power mirrors.
- Optional power steering column.
- Optional power adjustable pedals.

MEMORY FUNCTION PRECAUTIONS

WARNING: Before activating the memory seat, make sure that the area immediately surrounding the seat is clear of obstructions and that all occupants are clear of moving parts.

WARNING: Do not use the memory function when your vehicle is moving.

LOCATING THE MEMORY FUNCTION BUTTONS



The memory function buttons are on the driver door.

SAVING A PRESET POSITION

1. Adjust the memory features to your preferred position.
2. Press and hold the preferred preset button until you hear a single tone.

A confirmation message appears in the information display.

You can save up to three preset memory positions at any time.

RECALLING A PRESET POSITION

Press and release a preset button.

Note: You can recall a preset memory position when the ignition is off, or when you place the transmission in park (P) or neutral (N) if the ignition is on and the vehicle is not moving.

Note: Pressing any of the preset buttons or any memory feature control during a memory recall cancels the operation.

You can also recall a preset memory position by:

- Pressing the unlock button on your remote control if you linked it to a preset position.
- Unlocking the intelligent driver door handle if a linked remote control is present.

Using a linked remote control to recall your memory position when the ignition is off moves the seat and steering column to the easy entry position.

Linking a Preset Position to Your Remote Control or Passive Key

See **Linking or Unlinking a Personal Profile** (page 573).

Garage Door Opener (If Equipped)

GARAGE DOOR OPENER INTRODUCTION

HomeLink Wireless Control System

The universal garage door opener replaces the common handheld garage door opener with a three-button transmitter integrated into the driver-side sun visor.



How Does The Garage Door Opener Work

The system includes two primary features, a garage door opener and a platform for remote activation of devices within the home. You can program garage doors as well as entry gate operators, security systems, entry door locks and home or office lighting.

Garage Door Opener Limitations

Canadian radio-frequency laws require transmitter signals to time out, or quit, after several seconds – which may not be long enough for HomeLink to pick up the signal. U.S. gate operators time-out in the same manner.

GARAGE DOOR OPENER PRECAUTIONS AND FREQUENCIES

Garage Door Opener Precautions



WARNING: Do not use the system with any garage door opener that does not have the safety stop and reverse feature as required by U.S. Federal Safety Standards (this includes any garage door opener manufactured before April 1, 1982). A garage door opener which cannot detect an object, signaling the door to stop and reverse, does not meet current federal safety standards. Using a garage door opener without these features increases the risk of serious injury or death.

FCC and RSS-210 Industry Canada Compliance



WARNING: Changes or modifications not expressly approved by the party responsible for compliance could void the user's authority to operate the equipment. The term "IC:" before the radio certification number only signifies that Industry Canada technical specifications were met.

This device complies with Part 15 of the FCC Rules and with RSS-210 of Industry Canada. Operation is subject to the following two conditions: (1) this device may not cause harmful interference, and (2) this device must accept any interference received, including interference that may cause undesired operation.

Garage Door Opener (If Equipped)

This equipment complies with FCC radiation exposure limits set forth for an uncontrolled environment. End Users must follow the specific operating instructions for satisfying RF exposure compliance. This transmitter must be at least 20 cm (8 in) from the user and must not be co-located or operating in conjunction with any other antenna or transmitter.

PROGRAMMING THE GARAGE DOOR OPENER

To clear all stored codes in the garage door opener in your vehicle, use the **clear** function. To override one button, use the **reprogram** function.

Note: Make sure that the garage door and security device are free from obstruction when you are programming. Do not program the system with the vehicle in the garage.

Clearing the Garage Door Opener

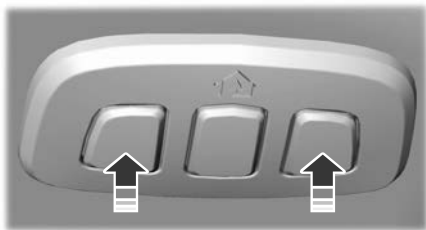

To clear all stored codes in the garage door opener in the vehicle:

1. Press and hold the outer two function buttons simultaneously for approximately 10 seconds until the indicator above the buttons flashes rapidly.
2. When the indicator flashes, release the buttons.

Note: This clears all stored codes. You cannot erase individual buttons.

Note: You can program a maximum of three devices. To change or replace any of the three devices after they have been initially programmed, you must either clear all codes, or reprogram each individual button.

Note: We recommend that upon the sale or lease termination of your vehicle, you erase the programmed function buttons for security reasons.

Reprogramming the Garage Door Opener

If a button on your garage door opener has already been programmed, you can override it. To program a device to a previously trained button:

1. Press and hold the desired button for approximately 20 seconds until the indicator begins to flash.
2. Without releasing the button, proceed to Step 3 of **Programming the Garage Door Opener to your Handheld Transmitter**.

Programming the Garage Door Opener to your Handheld Transmitter

Note: The programming steps below assume you are programming a HomeLink that was not previously programmed. If your HomeLink was previously programmed, you may need to **clear** or **reprogram** your HomeLink buttons.

Note: Put a new battery in the handheld transmitter. This allows for quicker training and accurate transmission of the radio-frequency signal.

Note: Make sure that the garage door and security device are free from obstruction when you are programming. Do not program the system with the vehicle in the garage.

Garage Door Opener (If Equipped)

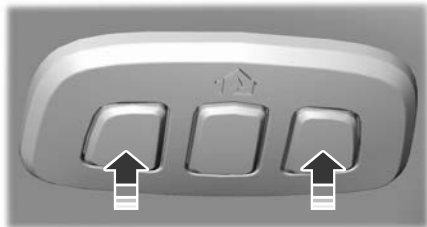

To program your in-vehicle HomeLink function button with your handheld transmitter:

1. With your vehicle parked outside of the garage, switch your vehicle on, but do not start your vehicle.
2. Press and release one of the three HomeLink function buttons that you would like to program.

Note: The indicator should begin to flash. If the indicator does not flash, press and hold the function button for 20 seconds until the indicator begins to flash.

3. Hold your handheld garage door transmitter 2–8 cm (1–3 in) away from the HomeLink button you want to program.
4. Press and hold the handheld transmitter button you want to program while watching the indicator on HomeLink. Continue to hold the handheld button until the HomeLink indicator flashes rapidly or is continuously on.

Note: You may need to use a different method if you live in Canada or have difficulties programming your gate operator or garage door opener.

5. Press and hold the HomeLink button you programmed for two seconds, then release. You may need to do this twice to activate the door.

Note: If the indicator stays on, the programming is complete.

Note: If the HomeLink indicator flashes rapidly, repeat Step 5.

Note: If your device still does not operate, you must program your garage door.

6. To program additional buttons, repeat Steps 1–4.

Note: Make sure you keep the original remote control transmitter for use in other vehicles as well as for future system programming.

Programming the Garage Door Opener to your Garage Door Opener Motor

Note: Make sure that the garage door and security device are free from obstruction when you are programming. Do not program the system with the vehicle in the garage.



1. Press the learn button on the garage door opener motor and then you have 30 seconds to complete the next two steps.
2. Return to your vehicle.

Garage Door Opener (If Equipped)



3. Press and hold one of the three HomeLink function buttons you want to program for two seconds, then release.
4. Repeat Step 3. Depending on your brand of garage door opener, you may need to repeat this sequence a third time.

Programming the Garage Door Opener to your Gate Opener Motor

Gate Operator / Canadian Programming

Canadian radio-frequency laws require transmitter signals to time-out (or quit) after several seconds of transmission – which may not be long enough for HomeLink to pick up the signal during programming. Similar to this Canadian law, some U.S. gate operators are designed to time-out in the same manner.

Note: *If programming a garage door opener or gate operator, it is advised that you unplug the device during the **cycling** process to prevent possible overheating.*

1. Press and release your handheld transmitter, **every two seconds**, until the HomeLink indicator flashes rapidly or is continuously on.
2. Release the handheld transmitter button.

3. Press and hold the HomeLink function button you want to program for two seconds, then release. You may need to do this twice to activate the door.

Note: *If the indicator stays on, the programming is complete.*

Note: *If the HomeLink indicator flashes rapidly, repeat Step 3.*

4. To program additional buttons, repeat Steps 1–4.

GARAGE DOOR OPENER ADDITIONAL ASSISTANCE

Video Setup Instructions

[Universal Garage Door Opener: HomeLink](#)

[Universal Garage Door Opener: HomeLink for Genie Intellicode 2](#)

[Universal Garage Door Opener HomeLink for Genie Intellicode](#)

Additional assistance can be found online at www.homelink.com/Ford or by calling the toll-free help line at 1-800-355-3515.

USB Ports

LOCATING THE USB PORTS

Data Transfer USB Ports



The USB ports could be in the following locations:

- On the lower instrument panel.
- Inside the center console.

Note: *These USB ports can also charge devices.*

Note: *Not all USB ports in your vehicle have data transfer capabilities.*

Note: *We recommend using only USB-IF certified cables and adapters. Non-certified cables and adapters may not work.*

Charge Only USB Ports



The USB ports could be in the following locations:

- On the lower instrument panel.
- On the upper instrument panel.
- Inside the media bin.
- Inside the center console.
- On the rear of the center console.
- Behind the first row seats.
- In the cargo area.

PLAYING MEDIA USING THE USB PORT

 **WARNING:** Driving while distracted can result in loss of vehicle control, crash and injury. We strongly recommend that you use extreme caution when using any device that may take your focus off the road. Your primary responsibility is the safe operation of your vehicle. We recommend against the use of any hand-held device while driving and encourage the use of voice-operated systems when possible. Make sure you are aware of all applicable local laws that may affect the use of electronic devices while driving.

Connect your device to a data transfer USB port.



Press the audio button on the feature bar.

Select **Sources**.



Select the USB option.



Press to play a track. Press again to pause the track.



Press to skip to the next track.

Press and hold to fast forward through the track.



Press once to return to the beginning of a track. Repeatedly press to return to previous tracks.

Press and hold to fast rewind.

CHARGING A DEVICE

Connect your device to the USB port.

USB Ports

Data Transfer USB Ports



You can charge your device through the data transfer USB port when SYNC is on.

Charge Only USB Ports



You can charge your device through the charge only USB port when the vehicle is in accessory mode or when the vehicle is running.

Power Outlet - Vehicles With: 110V Power Outlet

WHAT IS THE POWER OUTLET

The power outlet can power devices that require up to the rating on the outlet cover.

Note: The total power delivered is divided if more than one outlet is used.

POWER OUTLET PRECAUTIONS



WARNING: Do not use an extension cord or connect multiple devices to the power outlet. Doing so could result in overloading the power outlet. Failure to follow this instruction could result in fire, personal injury or property damage.



WARNING: Do not keep electrical devices plugged into the power outlet whenever the device is not in use. The outlet provides power when the vehicle is on. Failure to follow this instruction could result in personal injury.

POWER OUTLET LIMITATIONS

You should not use the power outlet for these types of electric devices:

- Cathode ray tube televisions.
- Motor loads, such as vacuum cleaners, electric saws or other electric power tools and compressor-driven refrigerators.
- Measuring devices which process precise data, such as medical equipment or measuring equipment.
- Other appliances requiring an extremely stable power supply, such as microcomputer-controlled electric blankets or touch sensor lamps.

Note: Some devices may exceed the power rating on the device label when they are initially plugged-in and may require you to press the device power button more than one time in order to allow a soft start. After multiple attempts, if the device remains off, please consider that your device may require more than the available power.

Note: The power outlet provides full available power when the vehicle is in park (P). Power availability may be reduced when the vehicle is in drive (D). If more than one outlet is available in the vehicle, power is divided between the outlets that are in use at the same time.

LOCATING THE POWER OUTLETS

The power outlet may be located on the instrument panel or the rear of the center console.

Instrument Panel



Power Outlet - Vehicles With: 110V Power Outlet

Rear of the Center Console



2. Switch your vehicle off to let the system cool and reset the fault mode.
3. Switch your vehicle back on, but do not plug your device back in.
4. With your vehicle on, make sure the indicator light remains on.
5. Make sure your device does not exceed the power limits and then plug in your device.

Note: *If a fault occurs again, your device may exceed the capacity available from the power outlet.*

POWER OUTLET INDICATORS

The power outlet indicator illuminates to let you know the status of the system.

Indicator Status	Description
On	When the indicator light is on, the outlet is providing power.
Off	When the indicator light is off, there is no power to the outlet.
Flashing	When the indicator light is flashing, the outlet is in a fault mode.

Fault mode

The power outlet temporarily turns off power if the device exceeds the watt limit.

1. Unplug your device.

Power Outlet - Vehicles With: 12V Power Outlet

WHAT IS THE POWER OUTLET

The power outlet can power devices using a 12 V outlet adapter.

POWER OUTLET PRECAUTIONS



WARNING: Do not plug electrical devices into the power outlets that exceed the maximum power rating. Incorrect use of the power outlets can cause damage not covered by the vehicle warranty, and can result in fire or personal injury.

When you switch the vehicle on, you can use the power outlets to power 12 V appliances with a maximum current rating of 15 A.

To prevent damage to the vehicle's battery:

- Do not use the power outlets over the vehicle capacity of 12 V DC 180 W or a fuse could blow.
- Do not plug in any device that supplies power to the vehicle through the power outlets. This could result in damage to vehicle systems.
- Do not hang any accessory from the accessory plug. Always keep the power outlets caps closed when not in use.
- Do not insert objects other than an accessory plug into the power outlets.

To prevent the battery from running out of charge:

- Do not use the power outlets longer than necessary when the vehicle is off.
- Do not leave devices plugged in overnight or when you park your vehicle for extended periods.
- Using devices for extended periods may require starting and running the engine to recharge the battery.

LOCATING THE POWER OUTLETS

The power outlet is on the instrument panel.

Onboard Generator (If Equipped)

WHAT IS THE ONBOARD GENERATOR

The vehicle functions as a portable generator and can power devices that require up to the rating listed on the power outlet label.

ONBOARD GENERATOR PRECAUTIONS



WARNING: Do not connect any vehicle power outlets to any premises. This can create a backfeed to utility lines. Failure to follow this instruction could result in property damage, fire, electrical shock or death.



WARNING: Do not keep electrical devices plugged into the power outlet whenever the device is not in use. The outlet provides power when the vehicle is on. Failure to follow this instruction could result in personal injury.



WARNING: Do not start the engine in a closed garage or in other enclosed areas. Exhaust fumes are toxic. Always open the garage door before you start the engine. Failure to follow this instruction could result in personal injury or death.



WARNING: Exhaust leaks may result in entry of harmful and potentially lethal fumes into the passenger compartment. If you smell exhaust fumes inside your vehicle, have your vehicle inspected immediately. Do not drive if you smell exhaust fumes.



WARNING: The vehicle's engine runs while the generator is switched on. Running engines emit carbon monoxide. Only use the generator when the vehicle is outdoors. Failure to follow this instruction could result in personal injury or death.

When you switch the power outlets on, the vehicle power down timer is disabled and the vehicle continues to be powered on.

Note: We recommend using UL approved devices for use with the power outlet.

Note: Make sure that plugged in devices do not exceed the ratings displayed on the outlet covers.

Note: Unplug electrical devices from the power outlet when they are not switched on.

Note: Make sure there is no damage to the outlets before driving your vehicle.

Note: Power could be limited during extreme hot or cold temperatures to optimize system performance.

Note: Close all outlet covers when not in use.

Note: Automatic engine stop is disabled and the gasoline engine will continue to idle when the outlet is switched on.

Note: Make sure that objects are not blocking the inverter inlet and exhaust near the rear underseat storage compartment.

Note: The climate control system may turn on and power may be limited during extreme hot or cold temperatures to optimize system performance.

Note: When the outlet is switched on and the vehicle is in park (P) the engine turns off 30 minutes after the low fuel warning is displayed. After the vehicle is turned off, generator mode only operates while driving or until the vehicle is refueled.

Onboard Generator (If Equipped)

Grounding Type

Neutral Floating

The neutral of the inverter generator is isolated from system ground.

Note: *If additional grounding measures are required, consult with a qualified electrician.*

LOCATING THE OUTLETS

The power outlets are in the cabin and bed of the vehicle.

Bed Outlet

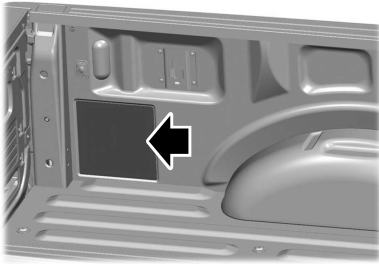

Note: *The outlet may be on the left or right-hand side of the bed depending on the vehicle.*

Instrument Panel Outlet



Rear Center Console Outlet



ONBOARD GENERATOR INDICATORS

Power Outlet Status Indicator

The power outlet indicator illuminates to let you know the status of the system.

Onboard Generator (If Equipped)

Indicator Status	Description
On	The power point is working and the vehicle is on.
Off	The power point is off and the vehicle is off.
Flashing	The power point is in fault mode.

Fault Mode

The power outlet temporarily turns off power if the device exceeds the watt limit.

1. Unplug your device.
2. Switch your vehicle off to let the system cool and reset the fault mode.
3. Switch your vehicle back on, but do not plug your device back in.
4. With your vehicle on, make sure the indicator light remains on.
5. Make sure your device does not exceed the power limits and then plug in your device.

Note: *If a fault occurs again, your device may exceed the capacity available from the power outlet.*

Generator Mode Power Indicator

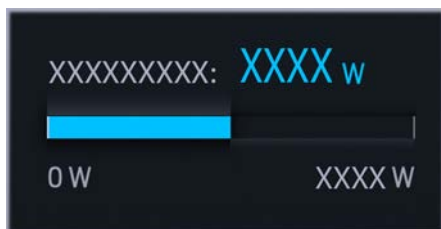

The generator mode power indicator displays the currently used power and total available power level on the touchscreen. When Generator Mode is switched off the indicator displays a reduced available power level. When generator mode is switched on the indicator displays the full available power.

Note: *Additional indicators may be available based on vehicle configuration.*

Note: *Make sure that plugged in devices do not exceed the available power displayed on the power mode indicator.*

Note: *Maximum power may be reduced when the vehicle is in drive (D).*

SWITCHING THE OUTLETS ON AND OFF

Using the Center Display Screen

1. Switch the vehicle on.
2. Press **Features** on the touchscreen.
3. Press **Pro Power Onboard**.

Using the Bed Controls



Press the button to switch the power outlet on and off.

Onboard Generator (If Equipped)

WHAT IS UTILITY IDLE MODE - VEHICLES WITH: FLIP KEY

Utility idle mode allows you to remove the key from the ignition and keep the vehicle and bed power point running.

SWITCHING UTILITY IDLE MODE ON AND OFF - VEHICLES WITH: FLIP KEY

Switching Utility Idle On

1. Start the vehicle. See **Starting and Stopping the Engine** (page 189).
2. Press **Features** on the touchscreen.
3. Press **Pro Power Onboard**.
4. Press **Generator Mode**.
5. Press **Utility Idle**.
6. Press the brake pedal once.
7. Turn the key to position **O**.
8. Remove the key from the ignition.

Switching Utility Idle Off using the Key

1. Insert the key into the ignition.
2. Turn the key to position **III**.

Switching Utility Idle Off using the Center Display Screen

1. Start the vehicle. See **Starting and Stopping the Engine** (page 189).
2. Press **Features** on the touchscreen.

3. Press **Pro Power Onboard**.
4. Press **Generator Mode**.
5. Press **Utility Idle**.
6. Press **Turn Vehicle Off**.

WHAT IS GENERATOR MODE

Generator mode uses the vehicle engine to increase power to the bed power outlets up to the rating listed on the power outlet label.

SWITCHING GENERATOR MODE ON AND OFF

1. Start the vehicle. See **Starting and Stopping the Engine** (page 189).
2. From the features menu, press Pro Power Onboard.
3. Press Generator Mode.

Note: *When the generator mode is off and the vehicle is on, you can power the devices up to 400W in the cabin through the low power mode.*

RESETTING GROUND FAULT DETECTION

After disconnecting all electrical loads the ground fault can be reset using the switches on the power point, on the instrument panel or on the touchscreen.

Use the controls on the touchscreen to test the ground fault detection circuit.

Onboard Generator (If Equipped)

ONBOARD GENERATOR – TROUBLESHOOTING

ONBOARD GENERATOR – INFORMATION MESSAGES

Message	Description
Item(s) plugged in exceeded the system's maximum capacity. Try unplugging one or more items and reset. See owner's manual for details.	Make sure that plugged in devices do not exceed the available power displayed. Devices could exceed the power rating shown the device label when plugged in. Unplug the device and switch the vehicle on and off to reset the system.
Generator system is outside its operating temperature and capability is reduced. See owner's manual for details.	Power could be limited during extreme hot or cold temperatures to optimize the performance of the system.
Another power source is trying to supply power to your vehicle's AC outlets. Disconnect vehicle from that power source. See owner's manual for details.	Do not plug in any device that supplies power to the vehicle through the power outlets. This could result in damage to vehicle systems.
This button tests outlets for proper operation of ground fault detection. In a successful test, Pro Power Onboard detects the ground fault and turns off. See owner's manual for details.	The power outlet is in fault mode. Make sure that all devices are unplugged from the system. Use the controls on the touchscreen to reset the system. Switch your vehicle on and off if the touchscreen controls are unable to reset the system. See an authorized dealer if these steps do not fix the fault.

Onboard Generator (If Equipped)

ONBOARD GENERATOR – FREQUENTLY ASKED QUESTIONS

Why is there a warning about something being plugged into the bed power outlet when I do not have anything plugged in?

- One or more of the bed power outlet covers could be ajar or broken. Make sure the generator is off and check the outlet covers. Select OK on the instrument cluster display to acknowledge the warning.

Why can I not shift my vehicle out of park (P)?

- Make sure the bed power outlet covers are closed and not damaged. Press OK on the instrument cluster display to acknowledge the warning to be able to shift out of park (P).

What do I do when my instrument cluster display is malfunctioning and I cannot acknowledge the warning to put the vehicle in drive (D).

- Power the vehicle off and make sure nothing is plugged into the bed power outlets and all outlet covers are closed. Start the vehicle and select OK on the instrument cluster display to acknowledge the warning. Have your vehicle serviced soon.

Center Console Work Surface (If Equipped)

USING THE CENTER CONSOLE WORK SURFACE

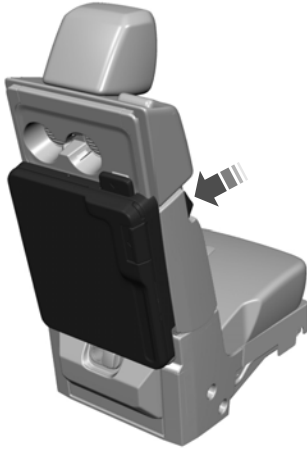

Push the lever on the side of the seat and fold the seat down.

There are three different positions:

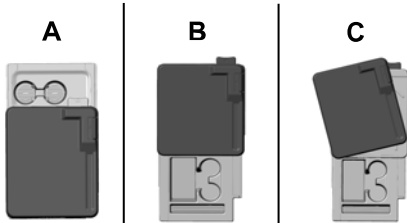

- A. Home.
- B. Forward.
- C. Rotated.



Push the latch down on the top of the work surface to move it to the forward position. There are 11 lockable positions.

Center Console Work Surface (If Equipped)

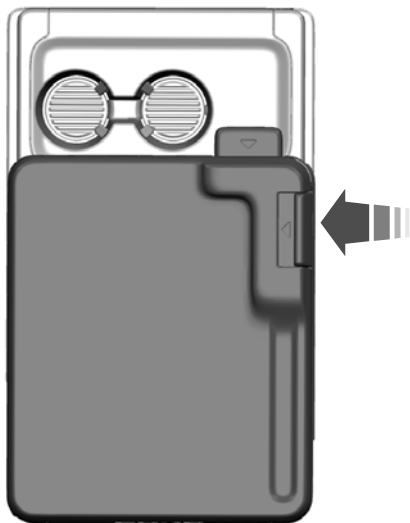

Push the latch on the side of the work surface to rotate it toward the driver. It rotates into 4 lockable positions in 5° increments.

Note: *The work surface must be in the home position when driving your vehicle.*

Note: *Do not drive with the work surface rotated. This could interfere with steering your vehicle.*

Note: *Do not adjust the steering column with a rotated work surface.*

Note: *Do not raise the seat when the work surface is in the forward or rotated positions to avoid damage.*

Note: *To avoid damaging the work surface, do not use it as a handle when entering or exiting the vehicle.*

CENTER CONSOLE WORK SURFACE – TROUBLESHOOTING

CENTER CONSOLE WORK SURFACE – INFORMATION MESSAGES

Message	Details
Stow work surface before driving	Displays when the work surface is not stowed and the vehicle is moving.

Wireless Accessory Charger (If Equipped)

WHAT IS THE WIRELESS ACCESSORY CHARGER

The wireless accessory charger allows you to charge one compatible Qi wireless charging device on the charging area.

WIRELESS ACCESSORY CHARGER PRECAUTIONS



WARNING: Wireless charging devices can affect the operation of implanted medical devices, including cardiac pacemakers. If you have any implanted medical devices, we recommend that you consult with your physician.



WARNING: Remove all metal objects like coins and keys from the charging surface and remove any metal objects attached to your mobile phone before placing the device on the charging surface. Some mobile devices or cases may attract metal objects. Metal objects on the charging surface or attached to the phone may become hot while charging is active. If an object is left on or near the charging surface or attached to the phone while the device is charging, let the objects cool before removing to prevent personal injury.

Keep the charging area clean and remove foreign objects prior to charging a device.

Do not place items with a magnetic strip or radio-frequency identification chip, for example passports, parking tickets, transportation passes or credit cards, near the charging area when charging a device. Damage could occur to the magnetic strip or radio-frequency identification chip.

Do not place metal objects, for example remote controls, coins and candy wrappers, on or near the charging area when charging a device. Metal objects may heat up and degrade the charging performance, in addition to causing interruptions in charging.

Charging could be interrupted, degraded, or could stop if any of the following occur:

- The system detects a foreign object.
- The device is misaligned on the charging area.
- The device moves on the active charging area when the vehicle is in motion.
- The vehicle ambient temperature is too high.
- You attempt to charge a non-Qi compatible device on the wireless charger.

Note: During charging, the device and the charger could heat up, this is normal. If the battery gets hotter than usual, the device may stop charging.

LOCATING THE WIRELESS ACCESSORY CHARGER



The charging area is in the center console media bin below the instrument panel.

CHARGING A WIRELESS DEVICE

Place the device on the center of the charging surface with the charging side down. The charging stops after your device reaches a full charge.

You can use the charger when the vehicle is in accessory mode, when the vehicle is running or when the touchscreen is on.

Wireless Accessory Charger (If Equipped)



Displays on the status bar when wireless charging is in progress.



Displays on the status bar when wireless charging has been interrupted.

Note: *The charging performance may be affected if your device is in a case. It may be necessary to remove the case to wirelessly charge your device.*

Note: *Software and firmware updates may affect device compatibility, including the use of unofficial software or firmware. You should verify charging functionality with your specific devices in-vehicle.*

WIRELESS ACCESSORY CHARGER VIDEOS

[Wireless Charging Pad Video Link](#)

Storage

CUP HOLDERS

CUP HOLDER PRECAUTIONS



WARNING: Use caution when stowing items or hot drinks in the cup holders. Items could become loose or spill during hard braking, acceleration or crashes. Failure to follow this instruction could result in personal injury.

GLOVE COMPARTMENT

OPENING THE GLOVE COMPARTMENT

Upper Glove Compartment (if Equipped)

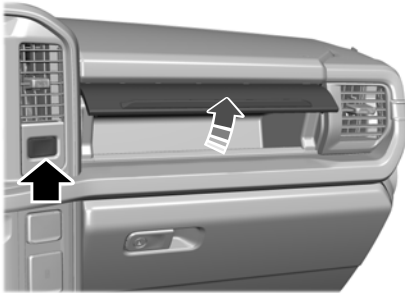

Push the button on the instrument panel to open.

Lower Glove Compartment



Pull the latch to the left to open.

LOCKING THE GLOVE COMPARTMENT

Use the key to lock the lower glove compartment.

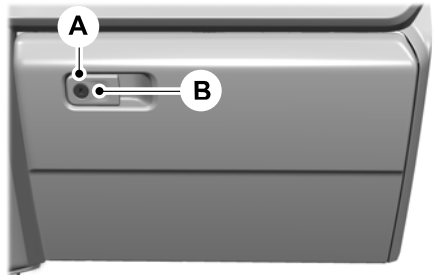

- A Unlock.
- B Lock.

Storage

CENTER CONSOLE

OPENING THE CENTER CONSOLE

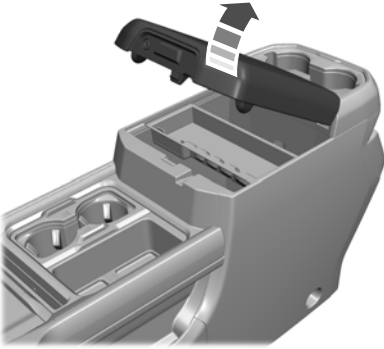

To open the center console push the button and lift up.

Media Bin

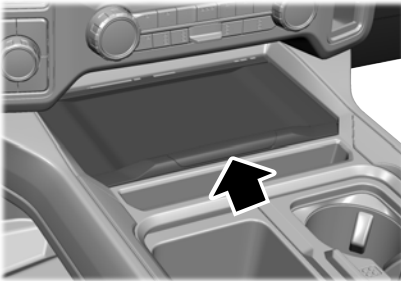

Push the door forward until it clicks. This allows access to the media bin.

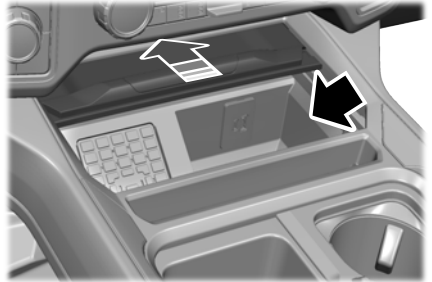

Push the door forward until it stops, then release. It automatically closes.

UNDER SEAT STORAGE (IF EQUIPPED)

LOCATING THE UNDER SEAT STORAGE COMPARTMENT

Front Under Seat Storage

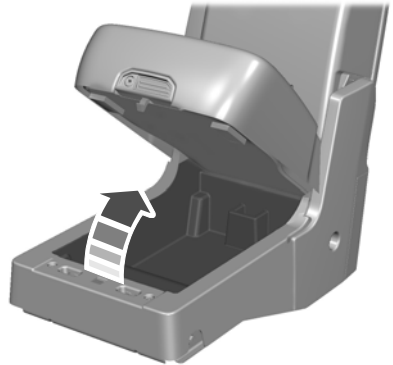

Lift the latch to access the storage compartment under the center seat cushion.

Storage

Locking the Front Under Seat Storage

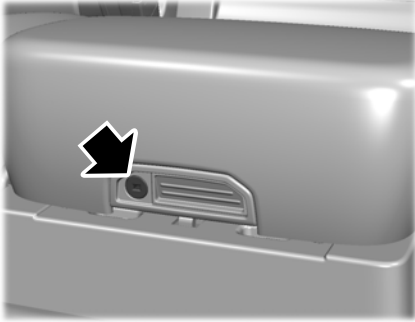

Lift the front seat to access the front under seat storage compartment.

1. Use the key in the remote control to unlock.

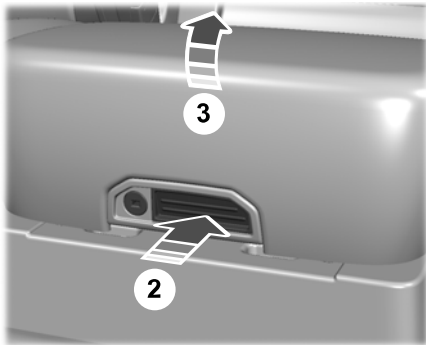

2. Press the latch to release the cushion.
3. Lift the cushion to access the storage compartment.

Rear Under Seat Storage



Lift the rear seat to access the under seat storage bin.

Locking the Rear Under Seat Storage



1. Lift the rear seat to access the under seat storage bin.

Storage

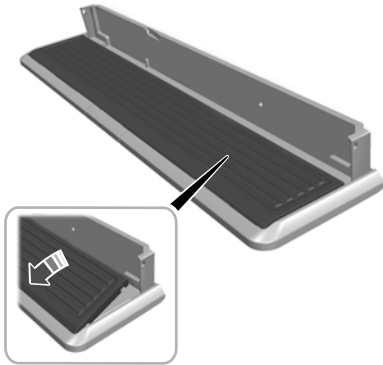

2. Lift the front panel to expand the storage bin.

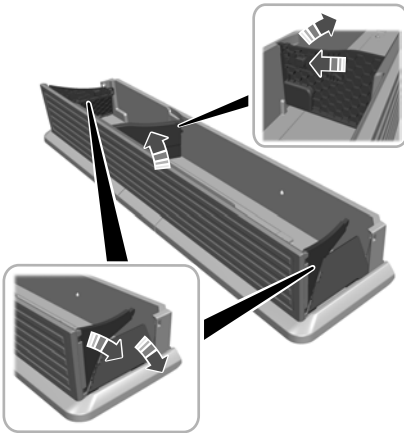

3. Lock the front and side panels in an open position.

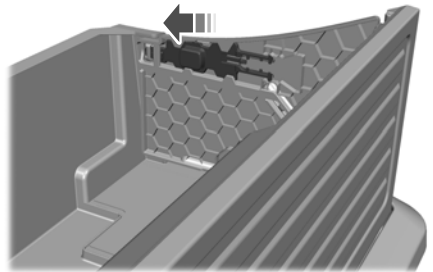

4. To collapse, unlatch the side panels and storage divider, push down to the stowed position and fold in the side and front panels.

Note: Make sure the storage divider is not locked into place when collapsing. Unlatch the sliding latch to release the storage divider and swing to the stowed position against the front panel.

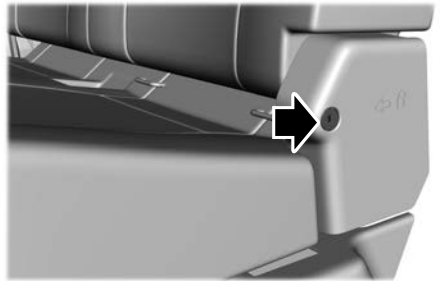

The locking key is in the remote control. Turn the key to lock or unlock the cushion.

Storage

GLASSES HOLDER

LOCATING THE GLASSES HOLDER

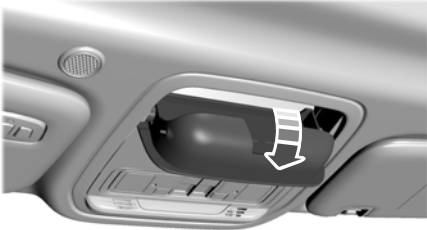

The glasses holder is in the overhead console.

Press near the rear edge of the door to open it.

Starting and Stopping the Engine

STARTING AND STOPPING THE ENGINE – PRECAUTIONS

WARNING: Extended idling at high engine speeds can produce very high temperatures in the engine and exhaust system, creating the risk of fire or other damage.

WARNING: Do not park, idle or drive your vehicle on dry grass or other dry ground cover. The emission system heats up the engine compartment and exhaust system, creating the risk of fire.

WARNING: Do not start the engine in a closed garage or in other enclosed areas. Exhaust fumes are toxic. Always open the garage door before you start the engine. Failure to follow this instruction could result in personal injury or death.

WARNING: Do not use starting fluid, for example ether, in the air intake system. Such fluid could cause immediate explosive damage to the engine and possible personal injury.

WARNING: Exhaust leaks may result in entry of harmful and potentially lethal fumes into the passenger compartment. If you smell exhaust fumes inside your vehicle, have your vehicle inspected immediately. Do not drive if you smell exhaust fumes.

The powertrain control system meets all Canadian interference-causing equipment standard requirements regulating the impulse electrical field or radio noise.

If you stop your vehicle and leave the engine idling for long periods, we recommend that you do one of the following:

- Open the windows at least 2.5 cm (1 in).
- Set your climate control to outside air.

IGNITION SWITCH - VEHICLES WITH: KEYED IGNITION



Note: Make sure the key is clean before inserting it into any lock cylinder.

Note: Do not leave the key in the ignition for an extended period of time when the engine is not running. This is to prevent the vehicle battery from losing charge.

Switching the Ignition Off

Turn the key to position **0**.

Starting and Stopping the Engine

Switching the Ignition to Accessory Mode

Turn the key to position **I**. Electrical accessories, for example the radio, operate without the engine running.

Switching the Ignition On

Turn the key to position **II**. All electrical circuits and accessories are operational and the warning lamps and indicators illuminate.

PUSH BUTTON IGNITION SWITCH - VEHICLES WITH: PUSH BUTTON START



Switching the Ignition Off

When the ignition is on or in accessory mode, press the push button ignition switch once without your foot on the brake pedal.

Switching the Ignition to Accessory Mode

When the ignition is off, press the push button ignition switch once without your foot on the brake pedal.

All electrical circuits and accessories are operational and the warning lamps and indicators illuminate.

Note: Your vehicle has a battery saver feature that shuts your vehicle off when it detects a certain amount of battery drain, or after approximately 30 minutes of inactivity in accessory mode.

Note: The system may not function if the passive key is close to metal objects or electronic devices, for example keys or a cell phone.

Note: You need a valid passive key inside your vehicle to switch the ignition on and start the engine.

STARTING THE ENGINE

STARTING A GASOLINE ENGINE - VEHICLES WITHOUT: PUSH BUTTON START

Before starting your vehicle, check the following:

- Make sure that the parking brake is on.
- Make sure that the transmission is in park (P).

1. Fully press the brake pedal.

Note: Do not touch the accelerator pedal.



2. Turn the key to position **III**. Release the key and wait until the engine starts.

Note: The engine may continue cranking for up to 15 seconds or until it starts.

Note: The engine takes longer to start at lower temperatures. It may crank for several seconds when very cold.

Starting and Stopping the Engine

STARTING A GASOLINE ENGINE - VEHICLES WITH: PUSH BUTTON START

Before starting your vehicle, check the following:

- Make sure that the parking brake is on.
- Make sure that the transmission is in park (P).

1. Fully press the brake pedal.

Note: Do not touch the accelerator pedal.



2. Press the push button ignition switch.

Note: The engine may continue cranking for up to 15 seconds or until it starts.

Note: The engine takes longer to start at lower temperatures. It may crank for several seconds when very cold.

STARTING A DIESEL ENGINE - VEHICLES WITHOUT: PUSH BUTTON START

Before starting your vehicle, check the following:

- Make sure that the parking brake is on.
- Make sure that the transmission is in park (P).



1. Turn the key to position II.

Note: Wait until the glow plug indicator turns off.

2. Fully press the brake pedal.

Note: Do not touch the accelerator pedal.



3. Turn the key to position III. Release the key and wait until the engine starts.

Note: The engine may continue cranking for up to 15 seconds or until it starts.

Note: The engine takes longer to start at lower temperatures. It may crank for several seconds when very cold.

Glow Plug Indicator



If it illuminates, wait until the glow plug indicator turns off before starting the engine.

STARTING A DIESEL ENGINE - VEHICLES WITH: PUSH BUTTON START

Before starting your vehicle, check the following:

- Make sure that the parking brake is on.
- Make sure that the transmission is in park (P).

1. Fully press the brake pedal.

Note: Do not touch the accelerator pedal.



2. Press the push button ignition switch.

Note: The engine may continue cranking for up to 15 seconds or until it starts.

Starting and Stopping the Engine

Note: The engine takes longer to start at lower temperatures. It may crank for several seconds when very cold.

Glow Plug Indicator



The engine does not start until the glow plug indicator turns off. This may take several seconds in extremely cold conditions.

RESTARTING THE ENGINE AFTER STOPPING IT - VEHICLES WITH: PUSH BUTTON START

The system allows you to start the engine within 10 seconds of switching it off, even if it does not detect a valid passive key.

Within 10 seconds of switching the engine off, fully press the brake pedal and press the push button ignition switch. After 10 seconds, you can no longer start the engine if the system does not detect a valid passive key.

When you start the engine, it remains running until you press the push button ignition switch, even if your vehicle does not detect a valid passive key. If you open and close a door when the engine is running, the system searches for a valid passive key.

ENGINE BLOCK HEATER (IF

EQUIPPED)

ENGINE BLOCK HEATER PRECAUTIONS



WARNING: Failure to follow engine block heater instructions could result in property damage or serious personal injury.



WARNING: Do not use your heater with ungrounded electrical systems or two-pronged adapters. There is a risk of electrical shock.



WARNING: Do not fully close the hood, or allow it to drop under its own weight when using the engine block heater. This could damage the power cable and may cause an electrical short resulting in fire, injury and property damage.

We recommend that you do the following for a safe and correct operation:

- Use a 16-gauge outdoor extension cord that is product certified by Underwriter's Laboratory (UL) or Canadian Standards Association (CSA). This extension cord must be suitable for use outdoors, in cold temperatures, and be clearly marked Suitable for Use with Outdoor Appliances. Do not use an indoor extension cord outdoors. This could result in an electric shock or become a fire hazard.
- Use as short an extension cord as possible.
- Do not use multiple extension cords.
- Make sure that when in operation, the extension cord plug and engine block heater cord plug connections are free and clear of water. This could cause an electric shock or fire.
- If the engine block heater cord is under the hood, do not remove the wiring from its original location. Do not close the hood on the extension wiring.
- Park your vehicle in a clean area, clear of combustible materials.
- Firmly connect the engine block heater cord and the extension cord.

Starting and Stopping the Engine

- Check the extension cord for heat anywhere when the system has been operating for approximately 30 minutes.
- Unplug and properly stow the system before starting and driving your vehicle. The protective cover seals the terminals of the engine block heater cord plug when not in use.
- Check the engine block heater system for proper operation before winter.

HOW DOES THE ENGINE BLOCK HEATER WORK

The engine block heater warms the engine coolant. This allows the climate control system to quickly respond. The equipment includes a heater element installed in the engine block and a wire harness. You can connect the system to a grounded 110 volt AC electrical source.

Note: *The engine block heater is most effective when outdoor temperatures are below -18°C (0°F). We recommend the use of engine block heater to improve engine cold start performance.*

USING THE ENGINE BLOCK HEATER

Make sure the receptacle terminals are clean and dry prior to use. Clean them with a dry cloth if necessary.

The heater uses 0.4 to 1.0 kilowatt-hours of energy per hour of use. The system does not have a thermostat. It achieves maximum temperature after approximately three hours of operation. Using the engine block heater longer than three hours does not improve system performance and unnecessarily uses electricity.

STOPPING THE ENGINE

STOPPING THE ENGINE WHEN YOUR VEHICLE IS STATIONARY - VEHICLES WITHOUT: PUSH BUTTON START

1. Shift into park (P).
2. Apply the parking brake.
3. Wait until the engine reaches idle speed.

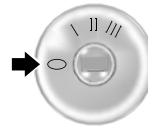

4. Turn the key to position **0**.

STOPPING THE ENGINE WHEN YOUR VEHICLE IS STATIONARY - VEHICLES WITH: PUSH BUTTON START

1. Shift into park (P).
2. Apply the parking brake.
3. Wait until the engine reaches idle speed.



4. Press the push button ignition switch.

Starting and Stopping the Engine

STOPPING THE ENGINE WHEN YOUR VEHICLE IS MOVING - VEHICLES WITHOUT: PUSH BUTTON START



WARNING: Switching off the engine when your vehicle is still moving results in a significant decrease in braking assistance. Higher effort is required to apply the brakes and to stop your vehicle. A significant decrease in steering assistance could also occur. The steering does not lock, but higher effort could be required to steer your vehicle. When you switch the ignition off, some electrical circuits, for example airbags, also turn off. If you unintentionally switch the ignition off, shift into neutral (N) and restart the engine.

Only in case of emergency, do the following:

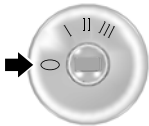

1. Turn the key to position **0**.
2. Shift into neutral (N) and use the brakes to safely bring your vehicle to a complete stop.
3. Shift into park (P).
4. Apply the parking brake.

STOPPING THE ENGINE WHEN YOUR VEHICLE IS MOVING - VEHICLES WITH: PUSH BUTTON START



WARNING: Switching off the engine when your vehicle is still moving results in a significant decrease in braking assistance. Higher effort is required to apply the brakes and to stop your vehicle. A significant decrease in steering assistance could also occur. The steering does not lock, but higher effort could be required to steer your vehicle. When you switch the ignition off, some electrical circuits, for example airbags, also turn off. If you unintentionally switch the ignition off, shift into neutral (N) and restart the engine.

Only in case of emergency, do the following:



1. Press and hold the push button ignition switch until the engine stops, or press it three times within two seconds.
2. Shift into neutral (N) and use the brakes to safely bring your vehicle to a complete stop.
3. Shift into park (P).
4. Apply the parking brake.

Starting and Stopping the Engine

IDLE TIMER (IF EQUIPPED)

WHAT IS IDLE TIMER

The idle timer system allows you to select how long the engine will idle before shutting down. It provides power to all equipment and accessories of the vehicle while active.

HOW DOES IDLE TIMER WORK

The vehicle shuts down after a set amount of time when you are done driving and you place the shifter in park (P) and leave the vehicle idling.

The idle timer defaults to active with the length of idle set to 30 minutes. You can change the length of time you would like the vehicle to idle before shutting down. It is possible to select any value from 1 to 30 minutes, in 1 minute increments. See **Idle Timer Settings** (page 195).

When the idle timer is active and your vehicle is idling, you retain full control of the vehicle's accessories and equipment.

After the idle time expires, the system turns your vehicle off. Your vehicle does not restart until you switch it on.

IDLE TIMER PRECAUTIONS



WARNING: Apply the parking brake, shift into park (P), switch the ignition off and remove the key before you open the hood or have any service or repair work completed. If you do not switch the ignition off, the engine could restart at any time. Failure to follow this instruction could result in personal injury or death.

IDLE TIMER SETTINGS

1. From the settings menu, press Vehicle. See **Center Display** (page 558).
2. Press Idle Settings.
3. Adjust the duration you wish the vehicle to idle.

AUTOMATIC ENGINE STOP (IF EQUIPPED)

WHAT IS AUTOMATIC ENGINE STOP

Automatic engine stop is a feature that switches the engine off if it has been idling for an extended period to help you save fuel.

HOW DOES AUTOMATIC ENGINE STOP WORK

Automatic engine stop turns the engine off. The ignition also turns off in order to save battery power. Before the engine shuts down, a message appears in the information display showing a timer counting down. If you do not intervene within 30 seconds, the engine shuts down. Another message appears in the information display to inform you that the engine has shut down in order to save fuel. Start your vehicle as you normally do.

SWITCHING AUTOMATIC ENGINE STOP ON AND OFF

1. From the settings menu, press Vehicle. See **Center Display** (page 558).
2. Switch 30min Max Idle on or off.

Note: You cannot permanently switch off the automatic shutdown. If you switch it off, it turns on each time you switch the ignition on.

Starting and Stopping the Engine

OVERRIDING AUTOMATIC ENGINE STOP

Note: You cannot permanently switch off the automatic engine stop feature. When you switch it off temporarily, it turns on at the next ignition cycle.

You can stop the engine shutdown, or reset the timer, at any point before the 30-second countdown has expired by doing any of the following:

- Pressing the brake pedal or accelerator pedal.
- Pressing the **OK** or **RESET** button during the countdown.

ACCESSING THE PASSIVE KEY BACKUP POSITION

If you are unable to start your vehicle, locate the backup slot in one of two positions:

Vehicles with center console storage:

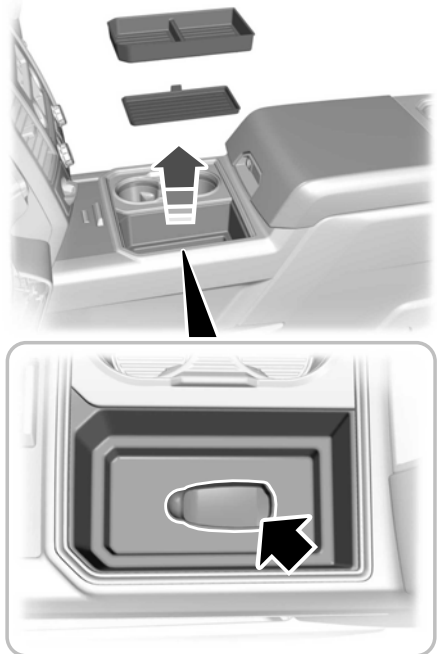

1. Remove the mat from the center console storage area.
2. Place the remote control in the backup slot with the buttons facing toward the rear of the vehicle.
3. Press the brake pedal.
4. Press the push button ignition switch to start the vehicle.

Vehicles without center console storage:

Starting and Stopping the Engine



1. Raise the center armrest storage lid.
2. Place the remote control in the backup slot with the buttons facing toward the rear of the vehicle.
3. Press the brake pedal.
4. Press the push button ignition switch to start the vehicle.

STARTING AND STOPPING THE ENGINE – TROUBLESHOOTING

STARTING AND STOPPING THE ENGINE – WARNING LAMPS

Malfunction Indicator Lamp



If it illuminates when the engine is running, the on-board diagnostics system is detecting a malfunction of the vehicle emission control system.

If it flashes, engine misfire could be occurring. Increased exhaust gas temperatures could damage the catalytic converter or other vehicle components. Avoid heavy acceleration and deceleration, and have your vehicle checked as soon as possible.

Powertrain Warning Lamp



If it illuminates when the engine is running, this indicates a powertrain or four-wheel drive fault. If it flashes when you are driving, immediately reduce the vehicle speed. Avoid heavy acceleration and deceleration, and have your vehicle checked as soon as possible.

If both lamps illuminate when the engine is running, stop your vehicle as soon as it is safe to do so. Continuing to drive your vehicle could cause reduced power or the engine to stop. Switch the ignition off and attempt to restart the engine. Have your vehicle checked as soon as possible.

Oil Pressure Warning Lamp



If it illuminates when you switch the ignition on. If it illuminates when the engine is running, this indicates a malfunction. Stop your vehicle and switch the engine off. Check the engine oil level. If the oil level is sufficient, this indicates a system malfunction. Have your vehicle checked as soon as possible.

Starting and Stopping the Engine

STARTING AND STOPPING THE ENGINE – INFORMATION MESSAGES

Message	Action
Cranking Time Exceeded	Displays if you exceed the starting time limit. You cannot attempt to start the engine for 15 minutes. If you cannot start the engine after 15 minutes passes, have your vehicle immediately checked.
Starting System Fault	Displays if you are unable to start your vehicle with a correctly coded key. The system has detected a fault that requires service. Have your vehicle checked as soon as possible.
No Key Detected	Displays if the system does not detect a valid passive key.

Starting and Stopping the Engine

STARTING AND STOPPING THE ENGINE – FREQUENTLY ASKED QUESTIONS - DIESEL, VEHICLES WITHOUT: PUSH BUTTON START

Why is the engine idle speed high when I start the engine?

- The speed the engine idles immediately after starting is optimized to minimize vehicle emissions and maximize cabin comfort and fuel economy.

Why is the engine not cranking?

The engine will not crank if:

- The vehicle battery does not have sufficient charge.
- The brake pedal is not pressed.
- The transmission is not in the park (P) or neutral (N).
- The starting system has been disabled after multiple attempts of starting the engine.

What should I do if the starting system is disabled?

- You can only attempt to start the engine for a set number of times before the starting system temporarily disables. If you exceed the limit, a message may appear and you need to wait at least 15 minutes to start the engine again.

Why do I experience different driving characteristics?

- If you disconnect the battery, your vehicle may exhibit some unusual driving characteristics for approximately 8 km (5 mi) after you reconnect it. This is because the engine management system must realign itself with the engine. You can disregard any unusual driving characteristics during this period.

STARTING AND STOPPING THE ENGINE – FREQUENTLY ASKED QUESTIONS - DIESEL, VEHICLES WITH: PUSH BUTTON START

Why is the engine idle speed high when I start the engine?

- The speed the engine idles immediately after starting is optimized to minimize vehicle emissions and maximize cabin comfort and fuel economy.

Why is the engine not cranking?

The engine will not crank if:

- The system does not detect a valid passive key.
- The passive key battery has no charge.
- The vehicle battery does not have sufficient charge.
- The brake pedal is not pressed.
- The transmission is not in the park (P) or neutral (N).
- The starting system has been disabled after multiple attempts of starting the engine.

Starting and Stopping the Engine

What should I do if the starting system is disabled?

- You can only attempt to start the engine for a set number of times before the starting system temporarily disables. If you exceed the limit, a message may appear and you need to wait at least 15 minutes to start the engine again.

Why do I experience different driving characteristics?

- If you disconnect the battery, your vehicle may exhibit some unusual driving characteristics for approximately 8 km (5 mi) after you reconnect it. This is because the engine management system must realign itself with the engine. You can disregard any unusual driving characteristics during this period.

Why does the system not detect a passive key?

- If the system does not detect a passive key and you are unable to start the engine, insert the passive key into the backup position and press the push button ignition switch to start the engine. See **Accessing the Passive Key Backup Position** (page 196).

STARTING AND STOPPING THE ENGINE – FREQUENTLY ASKED QUESTIONS - GASOLINE, VEHICLES WITHOUT: PUSH BUTTON START

Why is the engine idle speed high when I start the engine?

- The speed the engine idles immediately after starting is optimized to minimize vehicle emissions and maximize cabin comfort and fuel economy.

Why is the engine not cranking?

The engine will not crank if:

- The vehicle battery does not have sufficient charge.
- The brake pedal is not pressed.
- The transmission is not in the park (P) or neutral (N).
- The starting system has been disabled after multiple attempts of starting the engine.

What should I do if the starting system is disabled?

- You can only attempt to start the engine for a set number of times before the starting system temporarily disables. If you exceed the limit, a message may appear and you need to wait at least 15 minutes to start the engine again.

What should I do if the engine does not start?

- If you cannot start the engine after three attempts, wait 10 seconds and do the following:

1. Fully press the brake pedal.

Note: Make sure that the parking brake is applied.

Note: Make sure that the transmission is in park (P) or neutral (N).

2. Fully press and hold the accelerator pedal.



3. Turn the key to position III. Release the key and wait until the engine stops cranking.

Starting and Stopping the Engine

4. Release the accelerator pedal.
5. Turn the key to position **III**. Release the key and wait until the engine starts.

Why do I experience different driving characteristics?

- If you disconnect the battery, your vehicle may exhibit some unusual driving characteristics for approximately 8 km (5 mi) after you reconnect it. This is because the engine management system must realign itself with the engine. You can disregard any unusual driving characteristics during this period.

STARTING AND STOPPING THE ENGINE – FREQUENTLY ASKED QUESTIONS - GASOLINE, VEHICLES WITH: PUSH BUTTON START

Why is the engine idle speed high when I start the engine?

- The speed the engine idles immediately after starting is optimized to minimize vehicle emissions and maximize cabin comfort and fuel economy.

Why is the engine not cranking?

The engine will not crank if:

- The system does not detect a valid passive key.
- The passive key battery has no charge.
- The vehicle battery does not have sufficient charge.
- The brake pedal is not pressed.
- The transmission is not in the park (P) or neutral (N).
- The starting system has been disabled after multiple attempts of starting the engine.

What should I do if the starting system is disabled?

- You can only attempt to start the engine for a set number of times before the starting system temporarily disables. If you exceed the limit, a message may appear and you need to wait at least 15 minutes to start the engine again.

What should I do if the engine does not start?

- If you cannot start the engine after three attempts, wait 10 seconds and do the following:

1. Fully press the brake pedal.

Note: Make sure that the parking brake is applied.

Note: Make sure that the transmission is in park (P) or neutral (N).

2. Fully press and hold the accelerator pedal.
3. Press the push button ignition switch. See **Push Button Ignition Switch** (page 190).

Note: The engine cranks for a short period of time and then stops.

4. Release the accelerator pedal.
5. Press the push button ignition switch. See **Push Button Ignition Switch** (page 190).

Why do I experience different driving characteristics?

- If you disconnect the battery, your vehicle may exhibit some unusual driving characteristics for about 8 km (5 mi) after you reconnect it. This is because the engine management system must realign itself with the engine. You can disregard any unusual driving characteristics during this period.

Starting and Stopping the Engine

Why does the system not detect a passive key?

- If the system does not detect a passive key and you are unable to start the engine, insert the passive key into the backup position and press the push button ignition switch to start the engine. See **Accessing the Passive Key Backup Position** (page 196).

Fuel and Refueling

FUEL AND REFUELING PRECAUTIONS

 **WARNING:** Fuels can cause serious injury or death if misused or mishandled.

 **WARNING:** Fuel may contain benzene, which is a cancer-causing agent.

 **WARNING:** Read and follow all the instructions on the pump island.

 **WARNING:** When refueling always shut the engine off and never allow sparks or open flames near the fuel tank filler valve. Never smoke or use a cell phone while refueling. Fuel vapor is extremely hazardous under certain conditions. Avoid inhaling excess fumes.

Follow these guidelines when refueling:

- Extinguish all smoking materials and any open flames before refueling your vehicle.
- Switch the engine off before refueling.
- Automotive fuels can be harmful or fatal if swallowed. Fuel is highly toxic and if swallowed can cause death or permanent injury. If fuel is swallowed immediately call a physician, even if no symptoms are immediately apparent. The toxic effects of fuel may not be apparent for hours.
- Avoid inhaling fuel vapors. Inhaling fuel vapor can lead to eye and respiratory tract irritation. In severe cases, excessive or prolonged breathing of fuel vapor can cause serious illness and permanent injury.

- Avoid getting fuel in your eyes. If you splash fuel in your eyes, immediately remove contact lenses, if worn, flush with water for 15 minutes and seek medical attention. Failure to seek proper medical attention could lead to permanent injury.
- Fuels can be harmful if absorbed through the skin. If you splash fuel on your skin, clothing or both, promptly remove contaminated clothing and thoroughly wash your skin with soap and water. Repeated or prolonged skin contact causes skin irritation.
- Be particularly careful if you are taking Antabuse or other forms of Disulfiram for the treatment of alcoholism. Breathing fuel vapors could cause an adverse reaction, serious personal injury or sickness. Immediately call a physician if you experience any adverse reactions.

FUEL QUALITY

SELECTING THE CORRECT FUEL - GASOLINE

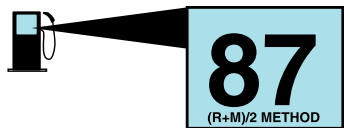

Your vehicle operates on regular unleaded gasoline with a minimum pump (R+M)/2 octane rating of 87.

Fuel and Refueling

Some fuel stations, particularly those in high altitude areas, offer fuels posted as regular unleaded gasoline with an octane rating below 87. The use of these fuels could result in engine damage that will not be covered by the vehicle Warranty.

For best overall vehicle and engine performance, premium fuel with an octane rating of 91 or higher is recommended. The performance gained by using premium fuel is most noticeable in hot weather as well as other conditions, for example when towing a trailer. See **Towing a Trailer** (page 366).

Do not be concerned if the engine sometimes knocks lightly. However, if the engine knocks heavily while using fuel with the recommended octane rating, contact an authorized dealer to prevent any engine damage.

We recommend Top Tier detergent gasolines, where available to help minimize engine deposits and maintain optimal vehicle and engine performance.

For additional information, visit www.toptiergas.com.

Note: *Use of any fuel for which the vehicle was not designed can impair the emission control system, cause loss of vehicle performance, and cause damage to the engine which may not be covered by the vehicle Warranty.*

Do not use:

- Diesel fuel.
- Fuels containing kerosene or paraffin.
- Fuel containing more than 15% ethanol (E15) or E85 fuel.
- Fuels containing methanol.
- Fuels containing metallic-based additives, including manganese-based compounds.

- Fuels containing the octane booster additive, methylcyclopentadienyl manganese tricarbonyl (MMT).
- Leaded fuel, using leaded fuel is prohibited by law.

The use of fuels with metallic compounds such as methylcyclopentadienyl manganese tricarbonyl, which is a manganese-based fuel additive, will impair engine performance and affect the emission control system.

SELECTING THE CORRECT FUEL FOR COLD WEATHER - 6.7L DIESEL

Choosing the Right Fuel: Vehicles Operated Where Ultra Low Sulfur Diesel Fuel Is Required (United States/Canada/Puerto Rico/U.S. Virgin Islands And Other Locales)

Note: *Your Warranty will not cover damage caused by using an improper type of fuel or fuel additive.*

Note: *Do not blend used engine oil with diesel fuel under any circumstances. Blending used oil with the fuel significantly increases your vehicle's exhaust emissions and reduce engine life due to increased internal wear.*

We recommend Top Tier diesel fuel where available to help minimize engine deposits and maintain optimal vehicle and engine performance.

For additional information, visit www.toptiergas.com.

Fuel and Refueling

You should use ultra-low sulfur diesel fuel designated as number 1-D or 2-D with a maximum of 15-ppm sulfur in your diesel vehicle. You can operate your vehicle on diesel fuels containing up to 20% biodiesel, also known as B20. These fuels should meet the ASTM D975 diesel or the ASTM D7467 B6-B20 biodiesel industry specifications. Outside of North America, use fuels meeting EN590 or equivalent local market standard.



Using low-sulfur diesel fuel (16-500 ppm) or high-sulfur diesel fuel (greater than 500 ppm) in your diesel engine will cause certain emission components to malfunction which could also cause the service engine soon light to illuminate indicating an emissions-related concern.

Diesel fuel is adjusted seasonally for cold temperature. For best results at temperatures below -7°C (19°F), we recommend using a diesel fuel which has been seasonally adjusted for the ambient conditions.

Choosing the Right Fuel: Vehicles Operated Where Ultra Low Sulfur Diesel Fuel Is Not Required

For the engine to operate reliably on low-sulfur or high-sulfur diesel fuel, the engine must be a factory-built high-sulfur engine (available as a dealer order option for select markets) or an ultra-low sulfur diesel fuel configured engine that has been retrofitted for high-sulfur diesel fuel using authorized dealer service parts. Failure to use retrofit components other than those available through your authorized dealer results in coolant system damage, engine overheating, selective catalyst reduction system or diesel particulate filter damage and possible base engine damage.

Use only a diesel engine configured for use with high-sulfur diesel fuel in markets with diesel fuel that has sulfur content greater than 15 ppm. Using low-sulfur diesel fuel (16–500 ppm) or high-sulfur diesel fuel (greater than 500 ppm) in a diesel engine designed to use only ultra-low sulfur diesel fuel could result in damage to engine emission control devices and the after treatment system, potentially rendering the vehicle inoperable.

Vehicles with engines configured for use with high-sulfur diesel fuel are only available for sale in countries where ultra-low sulfur diesel fuel is generally not available or mandated by the government. Vehicles originally sold in an ultra-low sulfur diesel fuel market that are subsequently exported to non-ultra low sulfur diesel fuel markets will need to be retrofitted at the customer's expense using Ford authorized dealer service parts in order to be reliably operated on non-ultra low sulfur diesel fuel.

Biodiesel



WARNING: Do not mix diesel with gasoline, gasohol or alcohol. This could cause an explosion.

Note: Do not use home heating oil, agricultural fuel, raw fats and oils, waste cooking greases, biodiesel greater than 20% or any diesel not intended for highway use. Damage to the fuel injection system, engine and exhaust catalyst, and diesel particulate filter can occur if you use an improper fuel. Red dye is used to identify fuels intended for agricultural and non-highway use.

You can operate your vehicle on diesel fuels containing up to 20% biodiesel, also known as B20.

Fuel and Refueling

Biodiesel fuel is a chemically converted product from renewable fuel sources, such as vegetable oils, animal fats and waste cooking greases.

To help achieve acceptable engine performance and durability when using biodiesel in your vehicle:

- Confirm the biodiesel content of the fuel to be B20 (20% biodiesel) or less.
- Only use biodiesel fuel of good quality that complies with industry standards.
- Follow the recommended service maintenance intervals. See **General Maintenance Information** (page 589).
- Do not store biodiesel fuel in the fuel tank for more than 1 month.
- Consider changing brands or reducing biodiesel content if you have cold temperature fuel gelling issues or a frequently appearing LOW FUEL PRESSURE message.

Use of biodiesel in concentrations greater than 20% can cause damage to your vehicle, including engine and/or exhaust after-treatment hardware (exhaust catalyst and particulate filter) failures. Concentrations greater than 20% can also cause fuel filter restrictions that could result in a lack of power or damage to fuel system components, including fuel pump and fuel injector failures.

We recommend SAE 5W-40 oil for fuels with greater than 5% biodiesel (B5). For more information about oil change intervals and other maintenance when operating on biodiesel. See **General Maintenance Information** (page 589).

Look for a label on the fuel pump to confirm the amount of biodiesel contained in diesel fuel. Ask the service station attendant to confirm the biodiesel content of diesel fuel, if you do not see a label on the fuel pump.

If you plan to park or store your vehicle for more than 1 month, then you should empty your vehicle fuel tank of biodiesel fuel. You should fill the tank with a pure petroleum-based diesel fuel and run your vehicle for a minimum of 30 minutes.

Note: *Degraded or oxidized biodiesel can damage fuel system seals and plastics and corrode steel parts.*

During cold weather, if you have problems operating on biodiesel, you may need to use diesel fuel with lower biodiesel content, try another brand or discontinue the use of biodiesel.

Diesel Fuel Additives

It should not be necessary to add any aftermarket additives to your fuel if you use a high-quality diesel fuel that conforms to ASTM industry specifications. Aftermarket additives can damage the fuel injector system or engine.

Use Motorcraft® cetane booster or an equivalent cetane booster additive if you suspect fuel has low cetane. Use Motorcraft® anti-gel and performance improver or an equivalent additive if there is fuel gelling.

Do not use alcohol-based additives to improve cetane quality, to prevent fuel gelling or any other use. The use of alcohol additives could result in damage to the fuel injectors and system.

Your Warranty may not cover repairs needed to correct the effects of using an aftermarket product that does not meet our specifications in your fuel.

Fuel and Refueling

RUNNING OUT OF FUEL

FILLING A PORTABLE FUEL CONTAINER



WARNING: Flow of fuel through a fuel pump nozzle can produce static electricity. This can cause a fire if you are filling an ungrounded fuel container.

Use the following guidelines to avoid electrostatic charge build-up, which can produce a spark, when filling an ungrounded fuel container:

- Only use an approved fuel container to transfer fuel to your vehicle. Place the container on the ground when filling it.
- Do not fill a fuel container when it is inside your vehicle (including the cargo area).
- Keep the fuel pump nozzle in contact with the fuel container when filling it.
- Do not use a device that holds the fuel pump nozzle lever in the fill position.

ADDING FUEL FROM A PORTABLE FUEL CONTAINER



WARNING: Do not pry open the fuel tank filler valve. This could damage the fuel system. Failure to follow this instruction could result in fire, personal injury or death.



WARNING: Do not dispose of fuel in the household refuse or the public sewage system. Use an authorized waste disposal facility.

When refueling the vehicle fuel tank from a fuel container, do the following:

1. Fully open the fuel filler door.

2. Turn the fuel filler cap counterclockwise and remove it.
3. Add fuel to your vehicle from the fuel container.
4. To replace the fuel filler cap, turn it clockwise until you feel a strong resistance and it clicks.
5. Fully close the fuel filler door.

Note: If your vehicle runs out of fuel add a minimum of 5 L (1.3 gal) of fuel to restart the engine.

Note: You may need to switch the ignition from off to on several times after refueling to allow the fuel system to pump the fuel from the tank to the engine. When restarting, cranking time takes a few seconds longer than normal.

REFUELING

REFUELING SYSTEM OVERVIEW

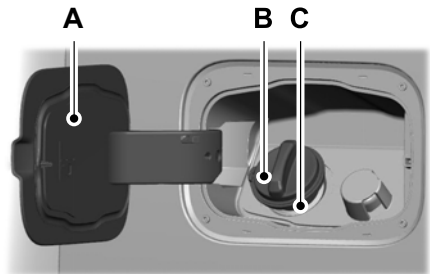

- A Fuel filler door.
B Fuel cap.
C Fuel tank filler pipe.

Fuel and Refueling

REFUELING YOUR VEHICLE

WARNING: When refueling always shut the engine off and never allow sparks or open flames near the fuel tank filler valve. Never smoke or use a cell phone while refueling. Fuel vapor is extremely hazardous under certain conditions. Avoid inhaling excess fumes.

WARNING: Fuel vapor burns violently and a fuel fire can cause severe injuries.

WARNING: The fuel system may be under pressure. If you hear a hissing sound near the fuel filler inlet, do not refuel until the sound stops. Otherwise, fuel may spray out, which could cause serious personal injury.

WARNING: Keep children away from the fuel pump. Never let children pump fuel.

WARNING: Do not pry open the fuel tank filler valve. This could damage the fuel system. Failure to follow this instruction could result in fire, personal injury or death.

WARNING: Stay outside your vehicle and do not leave the fuel pump unattended when refueling your vehicle.

WARNING: Do not remove the fuel pump nozzle from its fully inserted position when refueling.

WARNING: Stop refueling when the fuel pump nozzle automatically shuts off for the first time. Failure to follow this will fill the expansion space in the fuel tank and could lead to fuel overflowing.

WARNING: Do not overfill the fuel tank. The pressure in an overfilled tank may cause leakage and lead to fuel spray and fire.

WARNING: Wait at least five seconds before removing the fuel pump nozzle to allow any residual fuel to drain into the fuel tank.

1. Fully open the fuel filler door.
2. Remove the fuel filler cap by turning it counterclockwise.
3. Select the correct fuel pump nozzle for your vehicle.

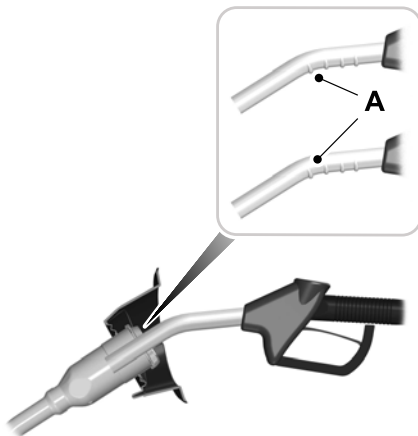

4. Insert the fuel pump nozzle up to the first notch. Keep the fuel pump nozzle resting on the fuel tank filler pipe.

Fuel and Refueling

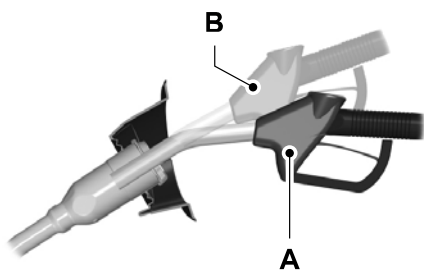

5. Hold the fuel pump nozzle in position A when refueling. Holding the fuel pump nozzle in position B can affect the flow of fuel and shut off the fuel pump nozzle before the fuel tank is full.

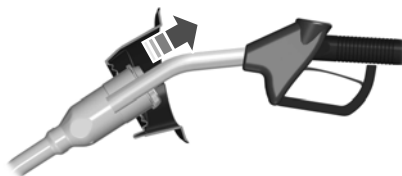

6. When the pump shuts off, wait five seconds, then raise the fuel pump nozzle and slowly remove it.
7. Install the fuel filler cap by turning it clockwise until it clicks.
8. Fully close the fuel filler door.

Note: Do not attempt to start the engine if you have filled the fuel tank with incorrect fuel. Incorrect fuel use could cause damage not covered by the vehicle Warranty. Have your vehicle immediately checked.

FUEL TANK CAPACITY - DIESEL

Capacities

Variant	Quantity
Complete vehicle-142 inch wheelbase, middle location.	109.8 L (29.0 gal)
Complete vehicle-160 inch and 164 inch wheelbase, middle location.	128.7 L (34.0 gal)
Complete vehicle-176 inch wheelbase, middle location.	181.7 L (48.0 gal)
Incomplete vehicle, middle location.	100.3 L (26.5 gal)
Incomplete vehicle, aft- axle -location.	151.4 L (40.0 gal)
Incomplete vehicle, middle and aft- axle - locations.	251.7 L (66.5 gal)

Fuel and Refueling

Advertised Capacity

The advertised capacity is the maximum amount of fuel that you can add to the fuel tank when the fuel gauge indicates empty.

In addition, the fuel tank contains an empty reserve. The empty reserve is an unspecified amount of fuel that remains in the fuel tank when the fuel gauge indicates empty.

Note: When refueling your vehicle after the fuel gauge indicates empty, you might not be able to refuel the full amount of the advertised capacity due to the empty reserve still present in the fuel tank.

FUEL TANK CAPACITY - GASOLINE

Capacities

Variant	Quantity
Complete vehicle-all except 176 inch wheelbase and incomplete vehicles.	128.7 L (34.0 gal)
Complete vehicle-176 inch wheelbase.	181.7 L (48.0 gal)
Incomplete vehicle, aft- axle -location.	151.4 L (40.0 gal)
Incomplete vehicle, middle location.	100.3 L (26.5 gal)

Advertised Capacity

The advertised capacity is the maximum amount of fuel that you can add to the fuel tank when the fuel gauge indicates empty.

In addition, the fuel tank contains an empty reserve. The empty reserve is an unspecified amount of fuel that remains in the fuel tank when the fuel gauge indicates empty.

Note: When refueling your vehicle after the fuel gauge indicates empty, you might not be able to refuel the full amount of the advertised capacity due to the empty reserve still present in the fuel tank.

FUEL AND REFUELING – TROUBLESHOOTING

FUEL AND REFUELING – WARNING LAMPS



If it illuminates when you are driving, refuel as soon as possible.

Fuel and Refueling

FUEL AND REFUELING – INFORMATION MESSAGES

Message	Action
Check Fuel Cap	You may not have installed the fuel filler cap properly. At the next opportunity, safely pull off of the road, remove the fuel filler cap, align the cap properly and reinstall it.

Diesel Particulate Filter - Diesel

WHAT IS THE DIESEL PARTICULATE FILTER

The diesel particulate filter is part of your vehicle's emissions system and filters harmful diesel particulates from the exhaust gas.

HOW DOES THE DIESEL PARTICULATE FILTER WORK

The diesel particulate filter reduces emissions by trapping exhaust particles before they reach the tailpipe. The system must periodically clean the exhaust particles that gather inside the filter. This is carried out in three ways, passive regeneration, active regeneration and manual regeneration.

Passive Regeneration

In passive regeneration, the normal exhaust system temperature cleans the filter by oxidizing the soot. Cleaning occurs during normal vehicle operating conditions due to driving patterns.

Active Regeneration

Once the diesel particulate filter is full, active regeneration raises the exhaust temperature to eliminate the particles.

When the engine control module detects that the diesel particulate filter is nearly full of particulates, and you are not operating your vehicle in a manner to allow effective regeneration, messages appear in the instrument cluster display as a reminder for you to drive your vehicle in order to clean the diesel particulate filter. If you drive your vehicle in a manner to allow effective regeneration, the instrument cluster display shows a cleaning exhaust filter message.

DIESEL PARTICULATE FILTER PRECAUTIONS



WARNING: Do not park or idle your vehicle over dry leaves, dry grass or other combustible materials. The regeneration process creates very high exhaust gas temperatures and the exhaust will radiate a considerable amount of heat during and after regeneration and after you have switched the engine off. This is a potential fire hazard.



WARNING: When the **Exhaust Filter Cleaning** message appears in the information display, do not park near flammable materials, vapors or structures until filter cleaning is complete.



WARNING: The normal operating temperature of the exhaust system is very high. Never work around or attempt to repair any part of the exhaust system until it has cooled. Use special care when working around the diesel oxidation catalytic converter or the diesel particulate filter. The diesel oxidation catalytic converter and the diesel particulate filter heat up to very high temperatures after only a short period of engine operation and remain hot after you switch the engine off.

Note: Avoid running out of fuel.

Note: During regeneration at low speed or engine idle, you may smell a hot metallic odor and could notice a clicking metallic sound. This is due to high temperatures reached during regeneration and is normal.

Note: Changes in the engine or exhaust sound may be heard during the regeneration process.

Diesel Particulate Filter - Diesel

Failure to perform active or manual regeneration when instructed could result in a clogged diesel particulate filter. If the diesel particulate filter fills beyond the regeneration threshold, your vehicle disables the ability for active and manual regeneration. This could result in irreversible damage your vehicle Warranty may not cover.

DIESEL PARTICULATE FILTER REQUIREMENTS

The diesel particulate filter on your vehicle requires periodic regeneration to maintain its correct function.

If your journeys meet one of the following conditions:

- You drive only short distances.
- You frequently switch the ignition on and off.
- Your journeys contain a high level of acceleration and deceleration.

You must carry out occasional trips with the following conditions to assist the regeneration process:

- Drive your vehicle in more favorable conditions, which you will find at higher vehicle speeds in normal driving, on a main road or freeway for a minimum of 20 minutes. This drive may include short stops that will not affect the regeneration process.
- Avoid prolonged idling and observe speed limits and road conditions.
- Do not switch the ignition off.
- Select a suitable gear to ideally maintain engine speed between 1500 and 3000 RPM.

DIESEL PARTICULATE FILTER MANUAL REGENERATION

WHAT IS DIESEL PARTICULATE FILTER MANUAL REGENERATION

Diesel particulate filter manual regeneration allows you to manually start regeneration of the diesel particulate filter at idle to clean the filter.

Note: *If you are not sure whether your vehicle has this feature, contact your authorized dealer.*

DIESEL PARTICULATE FILTER MANUAL REGENERATION PRECAUTIONS



WARNING: Stay clear of the exhaust tailpipe during regeneration. Hot exhaust gases can burn you badly.

You may not be able to use manual regeneration if the service engine soon warning lamp appears in the instrument cluster display.

Note: *During the use of manual regeneration, you may observe a light amount of white smoke. This is normal.*

DIESEL PARTICULATE FILTER MANUAL REGENERATION REQUIREMENTS

You can use the manual regeneration feature when a message appears in the instrument cluster display and you are not able to drive in a manner that allows effective automatic active regeneration or if you choose to manually start the regeneration of the diesel particulate filter while the vehicle is idle.

Diesel Particulate Filter - Diesel

Before you start manual regeneration, do the following:

- Make sure the parking brake is on.
- Shift into park (P) on stable, level ground.
- Park your vehicle outside of any structure.
- Park your vehicle 3–5 m (10–15 ft) away from any obstructions and away from materials that can easily combust or melt, for example paper, leaves, petroleum products, fuels, plastics and other dry organic material.
- Make sure there is a minimum of 1/8 tank of fuel.
- Make sure all fluids are at proper levels.

DIESEL PARTICULATE FILTER MANUAL REGENERATION LIMITATIONS

You cannot use manual regeneration until the diesel particulate filter load percentage has reached 100% or Full. The diesel particulate filter load percentage fluctuates up and down when driving your vehicle due to active and passive regenerations.

If your vehicle is operated with significant stationary operation, low speed drive cycles less than 40 km/h (25 mph), short drive cycles, drive time less than 15 minutes or the vehicle does not fully warm up, passive and active regeneration may not sufficiently clean the diesel particulate filter system.

Aftermarket devices or modifications to the exhaust system may reduce the effectiveness of the exhaust system as well as cause damage to the exhaust system or engine. This may also degrade vehicle performance and could lead to engine damage that may not be covered by the vehicle Warranty.

STARTING DIESEL PARTICULATE FILTER MANUAL REGENERATION

Start your vehicle and when it has reached the normal operating temperature, press the instrument cluster display control button on the steering wheel. See **Instrument Cluster Display** (page 132).

If the diesel particulate filter is near or at saturation, a message requesting permission to initiate filter cleaning appears in the instrument cluster display. See **Diesel Particulate Filter – Information Messages** (page 215). Answer yes to this prompt and then follow the next prompts regarding exhaust position required to initiate manual regeneration. Be sure to understand each prompt. If you are not sure what is being asked by each prompt, contact an authorized dealer. The display shows when the operation has started and finished. You can also drive to clean the filter.



When the system is at the point of oversaturation, the malfunction indicator lamp illuminates and a message appears in the instrument cluster display. You cannot initiate filter cleaning. Have your vehicle checked as soon as possible.

Once manual regeneration starts, engine speed increases and the cooling fan speed increases. The engine sound changes when the engine and cooling fan speeds increase.

It is not necessary to open the hood on the engine compartment. Once manual regeneration completes, the engine speed returns to normal idling. The exhaust system remains very hot for several minutes even after regeneration is complete. Do not park the vehicle over materials that could burn until the exhaust

Diesel Particulate Filter - Diesel

system has had sufficient time to cool. Depending on the amount of soot collected by the diesel particulate filter, ambient temperature and altitude, manual regeneration lasts approximately 30 minutes.

DIESEL PARTICULATE FILTER – TROUBLESHOOTING

DIESEL PARTICULATE FILTER – WARNING LAMPS



If there are any issues with the diesel particulate filter system, or when the system is at the point of oversaturation, the powertrain warning lamp and the malfunction indicator lamp illuminate to inform you that your vehicle requires service. You may not be able to initiate filter cleaning. Have your vehicle checked as soon as possible.

DIESEL PARTICULATE FILTER – INFORMATION MESSAGES

Message	Action
Exhaust Filter Cleaning	Your vehicle has entered the cleaning mode. Various engine actions will raise the exhaust temperature in the Diesel Particulate Filter system to burn off the particles (exhaust soot). After the vehicle burns the particles off, the exhaust temperature will return to normal levels. This message is NORMAL.
Exhaust Filter Overloaded Drive to Clean	The diesel particulate filter is full of particles (exhaust soot) and you are not operating the vehicle in a manner that allows normal cleaning. Drive the vehicle above 50 km/h (30 mph) when it is safe to do so, until the message turns off.
Exhaust Filter Overloaded Clean Now	
Exhaust Filter at Limit Clean Now	The diesel particulate filter is full of particles (exhaust soot) and you are not operating the vehicle in a manner that allows normal cleaning. Drive the vehicle above 50 km/h (30 mph) when it is safe to do so, until the message turns off.
Exhaust Filter at Limit Drive to Clean Now	
Exhaust Filter Drive Complete	Your diesel particulate filter is clean.

Diesel Particulate Filter - Diesel

Message	Action
Exhaust Filter Cleaned	Your diesel particulate filter is clean (OCR Only).
Exhaust Filter Cleaning Stopped	The manual regeneration process has stopped (OCR Only).
Exhaust Filter Over Limit Service Now	You must have your vehicle serviced by an authorized dealer. Ignoring this warning message could lead to reduced drivability and customer expense, including damage to the diesel particulate filter. Your new vehicle warranty may not cover this damage.

Selective Catalytic Reduction System - Diesel

WHAT IS THE SELECTIVE CATALYTIC REDUCTION SYSTEM

The selective catalytic reduction system helps reduce tailpipe emissions and requires Diesel Exhaust Fluid (DEF) to convert nitrogen oxides into nitrogen and water.

HOW DOES THE SELECTIVE CATALYTIC REDUCTION SYSTEM WORK

The selective catalytic reduction system injects diesel exhaust fluid into the exhaust system to enable correct selective catalytic reduction system function.

The usage of diesel exhaust fluid has increased from prior model years in order to meet more stringent emissions requirements. The diesel exhaust fluid usage ranges from approximately 2-6% of fuel burned (378.54 L (100.00 gal) of fuel requires approximately 7.57 L (2.00 gal) to 22.71 L (6.00 gal) of diesel exhaust fluid) depending on vehicle usage. Factors that influence diesel exhaust fluid usage may include:

- Payload/Towing
- Driving Style
- Altitude
- Humidity
- Temperature

SELECTIVE CATALYTIC REDUCTION SYSTEM PRECAUTIONS



WARNING: Keep diesel exhaust fluid out of reach of children. Avoid contact with skin, eyes or clothing. In case of contact with your eyes, flush immediately with water and get prompt medical attention. In case of contact with your skin, clean immediately with soap and water. If you swallow any diesel exhaust fluid, drink plenty of water, call a physician immediately.



WARNING: Only refill the diesel exhaust fluid tank in a well ventilated area. When you remove the diesel exhaust fluid tank filler cap or a diesel exhaust fluid container cap, ammonia vapors may escape. Ammonia vapors can be irritating to skin, eyes and mucous membranes. Inhaling ammonia vapors can cause burning to the eyes, throat and nose and cause coughing and watery eyes.



WARNING: Diesel exhaust fluid must be refilled when low or replaced when contaminated or your vehicle speed becomes limited to 80 km/h (50 mph). In these conditions, drive with caution and refill diesel exhaust fluid immediately. If the diesel exhaust fluid becomes empty or contaminated and fluid is not replaced, your vehicle becomes limited to engine idle only once stopped. In these conditions, be cautious where you stop your vehicle because you may not be able to drive long distances or maintain highway speeds until you refill or replace the diesel exhaust fluid.

Selective Catalytic Reduction System - Diesel



WARNING: Tampering with or disabling the selective catalytic reduction system results in severe vehicle performance limitation including eventual speed limiting to 8 km/h (5 mph).

Note: Do not put diesel exhaust fluid in the fuel tank. Do not start the engine if any amount of diesel exhaust fluid was added to the diesel fuel tank as it may lead to fuel pump and injector failure and may result in severe engine damage which your vehicle warranty may not cover. The diesel fuel tank must be completely drained and cleaned prior to being refilled with clean diesel fuel and starting the engine.

Selective catalytic reduction systems are sensitive to contamination of the diesel exhaust fluid. Maintaining the purity of the fluid is important to avoid system malfunctions. If you remove or drain the diesel exhaust fluid tank, do not use the same fluid to refill the tank. The system has a sensor to monitor fluid quality.

Driving without refilling, replacing contaminated diesel exhaust fluid, or having the selective catalytic reduction system repaired results in the following actions as required by the California Air Resources Board (CARB) and the U.S. Environmental Protection Agency (EPA):

- Within a preset distance to empty, speed is limited upon vehicle restart. Prior to this occurring a message appears in the instrument cluster display.
- Further vehicle operation without refilling or replacing contaminated diesel exhaust fluid causes the engine to enter an idle-only condition. This only occurs upon vehicle refueling, vehicle idling in park for 1 hour, or engine shutdown for 10 minutes or more and is indicated by a message in the instrument cluster display indicating required actions to resume normal operation. It is required to add a minimum of 3.8 L (1.0 gal) of diesel exhaust fluid to the tank to exit the idle-only condition, but your vehicle is still in the speed-limiting mode until you refill the tank completely.

Note: For vehicle speed limiting or idle-only condition, normal vehicle operation resumes when you refill the diesel exhaust fluid tank or repair the contaminated system. If the system is contaminated or inoperative, have your vehicle checked as soon as possible.

Selective Catalytic Reduction System - Diesel

SELECTIVE CATALYTIC REDUCTION SYSTEM REQUIREMENTS



Only use diesel exhaust fluid that is certified by the American Petroleum Institute (API).

You can purchase diesel exhaust fluid at an authorized dealer, or contact roadside assistance for help in finding a retailer that sells diesel exhaust fluid.

Note: *Non-certified diesel exhaust fluid use can cause damage that your Warranty may not cover*

SELECTIVE CATALYTIC REDUCTION SYSTEM GUIDELINES

- Diesel exhaust fluid is non-flammable, non-toxic, colorless and water-soluble liquid.
- In order for the system to operate correctly you must maintain the diesel exhaust fluid level.
- Do not overfill the diesel exhaust fluid tank.
- Diesel exhaust fluid is corrosive.

- Avoid spilling diesel exhaust fluid on painted surfaces, carpeting or plastic components. Immediately wipe away any diesel exhaust fluid that has spilled with a damp cloth and water. If it has already crystallized, use warm water and a sponge.
- Do not store the diesel exhaust fluid bottle in your vehicle. If it leaks it could cause damage to interior components or release an ammonia odor inside your vehicle.
- Do not re-use the diesel exhaust fluid container once it is emptied.
- Store diesel exhaust fluid out of direct sunlight and in temperatures between -5–20°C (23–68°F).
- The system has a diesel exhaust fluid quality sensor. Dilution of diesel exhaust fluid or use of any other liquid in the selective catalytic reduction system leads to a diesel exhaust fluid system fault, eventually leading to the vehicle only operating in idle-only mode.
- Do not dilute diesel exhaust fluid with water or any other liquid.

FILLING THE SELECTIVE CATALYTIC REDUCTION SYSTEM TANK

FILLING THE SELECTIVE CATALYTIC REDUCTION SYSTEM TANK IN COLD WEATHER

Diesel exhaust fluid may freeze if the ambient temperature is below -11°C (12°F). Your vehicle has a preheating system which allows diesel exhaust fluid to operate below -11°C (12°F). If you do not use your vehicle for an extended period when the ambient temperature is below -11°C (12°F), the fluid in the tank may freeze.

Selective Catalytic Reduction System - Diesel

If the DEF tank is frozen, it may not recognize when the tank is refilled. The DEF level will update once the tank thaws out. It is best to fill the DEF tank prior to, or after a drive cycle greater than 20 minutes to allow the remaining frozen DEF in the tank to liquefy. If the tank is overfilled and the fluid freezes it may cause damage that your Warranty will not cover.

Note: After filling the DEF tank, there may be a short period before the increased level is registered.

FILLING THE SELECTIVE CATALYTIC REDUCTION SYSTEM TANK USING A FUEL STATION PUMP

Filling the diesel exhaust fluid tank using a fuel station pump is similar to refueling your vehicle.

1. Fully open the fuel filler door.

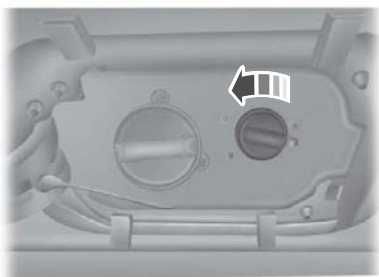

2. Remove the diesel exhaust fluid tank filler cap.

Note: The diesel exhaust fluid tank has a blue filler cap.

3. Fully insert the diesel exhaust fluid pump nozzle.

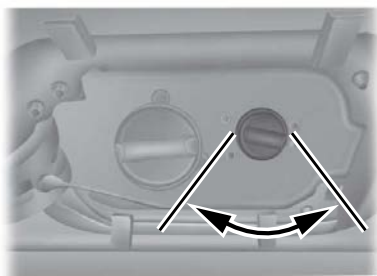

4. Operate the diesel exhaust fluid pump nozzle within the area shown.

Note: The pump nozzle shuts off when the tank is full.

5. Slightly raise the diesel exhaust fluid pump nozzle and then slowly remove it.
6. Replace the diesel exhaust fluid tank filler cap. Turn it clockwise until you feel a strong resistance and it clicks.

Note: After filling the DEF tank, there may be a short period before the increased level is registered.

FILLING THE SELECTIVE CATALYTIC REDUCTION SYSTEM TANK USING A PORTABLE CONTAINER

The following procedure applies to Motorcraft diesel exhaust fluid or similar fluid containers. Follow the manufacturer's instructions.

1. Fully open the fuel filler door.
2. Remove the diesel exhaust fluid container cap.
3. Place the spout on to the container and tighten it until you feel a strong resistance.

Selective Catalytic Reduction System - Diesel

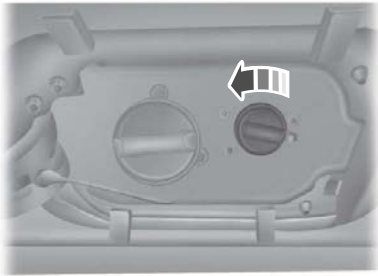

4. Remove the diesel exhaust fluid tank filler cap.

Note: The diesel exhaust fluid tank has a blue filler cap.

5. Insert the spout into the filler neck until the seal on the spout fully seats.
6. Pour the fluid into the tank.

Note: The fluid stops flowing when the tank is full.

7. Return the container to the vertical position slightly below the diesel exhaust fluid filler neck.
8. Allow any fluid remaining in the spout to drain back into the container.
9. Remove the spout from the diesel exhaust fluid filler neck.
10. Replace the diesel exhaust fluid tank cap. Turn it clockwise until you feel a strong resistance and it clicks.
11. Remove the spout from the diesel exhaust fluid container and replace the cap.

Note: If there is diesel exhaust fluid left in the container retain it for later use. The spout is reusable. Wash the spout with clean water prior to storage. Do not use the diesel exhaust fluid spout with any other fluid.

Note: After filling the DEF tank, there may be a short period before the increased level is registered.

CHECKING THE SELECTIVE CATALYTIC REDUCTION SYSTEM STATUS

The instrument cluster display shows a series of messages about the amount of diesel exhaust fluid available. A systems check displays messages indicating the amount of diesel exhaust fluid available or displays a warning message indicating the approximate distance remaining as the fluid in the diesel exhaust fluid tank nears empty. See **Selective Catalytic Reduction System – Information Messages** (page 223).

DIESEL EXHAUST FLUID CAPACITY AND SPECIFICATION

Use fluid that meets the defined specification.

If you do not use fluid that meets the defined specification, it could result in:

- Component damage that your vehicle warranty does not cover.
- Reduced vehicle performance.

Selective Catalytic Reduction System - Diesel

Capacities

Variant	Quantity
Complete vehicle.	28.4 L (7.5 gal)
Incomplete vehicle.	27.3 L (7.2 gal)

Materials

Name	Specification
Motorcraft® Diesel Exhaust Fluid(U.S.) Motorcraft® Diesel Exhaust Fluid / Fluide pour échappement diesel Motorcraft®(Canada) PM-27-GAL,PM-27-JUG(U.S.) CPM-27-JA(Canada)	WSS-M99C130-A

SELECTIVE CATALYTIC REDUCTION SYSTEM – TROUBLESHOOTING

SELECTIVE CATALYTIC REDUCTION SYSTEM – WARNING LAMPS



As the diesel exhaust fluid level nears empty, the warning symbol displays and a series of tones and messages begin at 800 km (500 mi) remaining and continue to just before the diesel exhaust fluid is depleted.

This is regardless of the level indicated on the diesel exhaust fluid gauge. In some instances under heavy load, the low diesel exhaust fluid warning could be displayed with more than half of the diesel exhaust fluid tank remaining. The warning symbol and messages continue until you refill the diesel exhaust fluid tank.

The warning lamp illuminates and a message appears in the instrument cluster display if the system becomes contaminated or inoperative.

Selective Catalytic Reduction System - Diesel

SELECTIVE CATALYTIC REDUCTION SYSTEM – INFORMATION MESSAGES

Message	Action
DEF Level Range: XX mi/ km Refill Now	The distance you can travel before depleting the remaining diesel exhaust fluid. Refill as soon as possible.
DEF Level Empty Speed Limited to XX MPH / km/h in XX mi/km	Your diesel exhaust fluid is nearing empty. Your vehicle's top speed will become limited in the displayed distance. You must replenish the diesel exhaust fluid to resume normal operation of your vehicle. See Diesel Exhaust Fluid Capacity and Specification (page 221).
DEF Level Empty Speed Limited to XX MPH/km/h Upon Restart	Your remaining diesel exhaust fluid has depleted. Your speed will be limited upon restart. You must replenish the diesel exhaust fluid to resume normal operation of your vehicle. See Diesel Exhaust Fluid Capacity and Specification (page 221).
DEF Level Low Speed Limited to XX MPH/km/h	The diesel exhaust fluid is empty. You must replenish the diesel exhaust fluid to resume normal operation of your vehicle. See Diesel Exhaust Fluid Capacity and Specification (page 221).
DEF Level Empty Engine Idled Soon	The selective catalytic reduction system detects low exhaust fluid. The engine will eventually enter into an idle only mode. You must replenish the diesel exhaust fluid to resume normal operation of your vehicle. See Diesel Exhaust Fluid Capacity and Specification (page 221).
DEF Level Empty Engine Idled See Manual	The vehicle will enter into an idle only mode. You must replenish the diesel exhaust fluid to resume normal operation of your vehicle. See Diesel Exhaust Fluid Capacity and Specification (page 221).
DEF Fault Speed Limited to XX MPH/km/h in XX mi/km	The selective catalytic reduction system detects a fault. The vehicle's top speed will become limited in the displayed distance and count down from this point. Have your vehicle checked as soon as possible.

Selective Catalytic Reduction System - Diesel

Message	Action
DEF Fault Speed Limited to XX MPH/km/h Upon Restart	The selective catalytic reduction system detects a fault. The vehicle's top speed will become limited upon restarting. Have your vehicle checked as soon as possible.
DEF Fault Speed Limited to XX MPH/km/h	The selective catalytic reduction system detects a fault. The vehicle's top speed is limited. Have your vehicle checked as soon as possible.
DEF Fault Engine Idled Soon	The selective catalytic reduction system detects a fault. The engine will eventually enter into an idle only mode. Have your vehicle checked as soon as possible.

Catalytic Converter

WHAT IS THE CATALYTIC CONVERTER

The catalytic converter is part of your vehicle's emissions system and filters harmful pollutants from the exhaust gas.

CATALYTIC CONVERTER PRECAUTIONS



WARNING: Do not park, idle or drive your vehicle on dry grass or other dry ground cover. The emission system heats up the engine compartment and exhaust system, creating the risk of fire.



WARNING: The normal operating temperature of the exhaust system is very high. Never work around or attempt to repair any part of the exhaust system until it has cooled. Use special care when working around the catalytic converter. The catalytic converter heats up to a very high temperature after only a short period of engine operation and stays hot after the engine is switched off.



WARNING: Exhaust leaks may result in entry of harmful and potentially lethal fumes into the passenger compartment. If you smell exhaust fumes inside your vehicle, have your vehicle inspected immediately. Do not drive if you smell exhaust fumes.

To avoid damaging the catalytic converter:

- Do not crank the engine for more than 10 seconds at a time.
- Do not run the engine with a spark plug lead disconnected.
- Do not push-start or tow-start your vehicle. Use booster cables. See **Jump Starting the Vehicle** (page 425).

- Use the correct fuel. See **Fuel and Refueling** (page 203).
- Do not switch the ignition off when your vehicle is moving.
- Avoid running out of fuel.
- Have the items listed in scheduled maintenance information performed according to the specified schedule.

Note: Do not make any unauthorized changes to your vehicle or engine. By law, vehicle owners and anyone who manufactures, repairs, or services a fleet of vehicles are not permitted to intentionally remove an emission control device or prevent it from working.

CATALYTIC CONVERTER – TROUBLESHOOTING

CATALYTIC CONVERTER – WARNING LAMPS

Your vehicle has an on-board diagnostics system that monitors the emission control system. If any of the following warning lamps illuminate, this may indicate that the on-board diagnostics system has detected an emission control system malfunction.



Continuing to drive your vehicle may cause reduced power or the engine to stop. Failure to respond to a warning lamp may cause damage that your vehicle Warranty may not cover. Have your vehicle checked as soon as possible.

Automatic Transmission

AUTOMATIC TRANSMISSION POSITIONS

AUTOMATIC TRANSMISSION PRECAUTIONS



WARNING: Apply the parking brake, shift into park (P), switch the vehicle off and remove the key or remote control before you leave your vehicle. Failure to follow this instruction could result in personal injury or death.



WARNING: When your vehicle is stationary, keep the brake pedal fully pressed when shifting gears. Failure to follow this instruction could result in personal injury, death or property damage.



WARNING: Do not apply the brake pedal and accelerator pedal simultaneously. Applying both pedals simultaneously for more than a few seconds limits vehicle performance, which may result in difficulty maintaining speed in traffic and could lead to serious injury.

SHIFTING YOUR VEHICLE INTO GEAR

The transmission selector is on the steering column.



1. Press and hold the brake pedal.
2. Move the lever to select a position.
3. Press the low (L) or manual (M) button when your vehicle is in drive (D) to enter or exit mode.

PARK (P)



WARNING: Shift into park (P) only when your vehicle is stationary.

In park (P) power is not transmitted to the driven wheels.

Note: A tone sounds if you attempt to exit your vehicle without the vehicle in park (P).

Note: Your vehicle may not shift out of park (P) if the 12 V battery has run out of charge.

Note: Your vehicle may not shift out of park (P) if a fuse is blown.

Note: Your vehicle may not shift out of park (P) unless the key or remote control is inside your vehicle.

Note: The electronic parking brake could apply when you power your vehicle on with the selector in park (P).

Note: The electronic parking brake could apply if you shift to park (P) without fully pressing the brake pedal.

Automatic Transmission

Note: The electronic parking brake could apply if you shift to park (P) on a slope.

Note: Do not manually release the parking brake when the selector is in park (P). See **Automatically Releasing the Electric Parking Brake** (page 256).

REVERSE (R)



WARNING: Shift into reverse (R) only when your vehicle is stationary.

In reverse (R) power is transmitted to the driven wheels.

NEUTRAL (N)



WARNING: In neutral (N) your vehicle is free to roll.

In neutral (N) power is not transmitted to the driven wheels.

DRIVE (D)

In drive (D) power is transmitted to the driven wheels.

Note: Progressive range selection is available in drive (D). See **Using Progressive Range Selection** (page 229).

MANUAL (M)

In manual (M) you can select a specific gear. See **Manually Shifting Gears** (page 227).

Note: We recommend using this mode for driving on hilly or mountainous roads or when towing a trailer. See **Towing a Trailer** (page 366).

AUTOMATIC TRANSMISSION POSITION INDICATORS

The instrument cluster displays the current position.



Note: The position could illuminate on the transmission selector.

MANUALLY SHIFTING GEARS

The instrument cluster displays the current gear. The current gear flashes when your vehicle cannot shift into the requested gear. Your vehicle will not shift if the requested gear raises or lowers the engine speed beyond the limit.

Your vehicle could shift when you fully press the accelerator or brake pedal.

Note: Prolonged driving with high engine speed could cause vehicle damage not covered by vehicle warranty.

Note: Drive modes could affect when the vehicle shifts into the requested gear.

Automatic Transmission



Manually Shifting Gears in Manual (M)

Use this feature to select a specific gear.

Note: We recommend using this feature for engine braking, driving on hilly or mountainous roads, or when towing a trailer. See **Towing a Trailer** (page 366).

- Shift to manual (M) or with the selector in drive (D) press the manual (M) button to switch the feature on.
- Press the upper (+) button to upshift.
- Press the lower (-) button to downshift.
- Shift to drive (D) or press the manual (M) button again to switch the feature off.

USING POWER TAKE-OFF (IF EQUIPPED)

How Does the Power Take-Off Work

Auxiliary equipment called power take-off, is often added to the engine or transmission to operate utility equipment. Examples include a wheel-lift for tow trucks, cranes, tools for construction or tire service, and pumping fluids. Power take-off applications draw auxiliary horsepower

from the powertrain, often while the vehicle is stationary. In this condition, there is limited cooling air flow through the radiator and around the vehicle that normally occurs when a vehicle is moving. The aftermarket power take-off system installer is responsible for determining whether additional chassis heat protection or powertrain cooling is required.

Note: Use of auxiliary equipment that exceeds the maximum power take-off load specified in our *Truck Body Builders Layout Book* can adversely affect the performance of the powertrain system. Refer to the *Body Builders Layout Book* for instructions about the appropriate installation of additional equipment.

For more information scan here:



What is the Split Shaft Capability

The split shaft capability feature allows you to install an aftermarket split shaft gearbox in your vehicle's driveline and run one or two power take-offs on the gearbox. The output of the transmission or transfer case connects directly with the split shaft gearbox and allows the engine to power the power take-off when the engine is running and the split shaft software is enabled.

This feature is approved as a stationary power source, within the limits and operating guidelines detailed in our *Truck Body Builders Layout Book*.

For more information scan here:

Automatic Transmission



AUTOMATIC TRANSMISSION AUDIBLE WARNINGS

Sounds if any of the following occur:

- You switch your vehicle off before shifting into park (P).
- You open the driver door before shifting into park (P).

USING PROGRESSIVE RANGE SELECTION

Progressive range selection gives you the ability to lock out gears from the automatic shifting range. This could provide you with an improved driving experience by reducing transmission shifts, for example in slippery conditions or steep slopes or when towing a trailer. See **Towing a Trailer** (page 366).

Materials

Name	Specification
Motorcraft® MERCON® ULV Automatic Transmission Fluid(U.S.) Motorcraft® MERCON® ULV Automatic Transmission Fluid / MERCON® ULV huile pour boîtes automatique Motorcraft®(Canada) XT-12-QULV(U.S. & Canada)	WSS-M2C949-A,

With the transmission in drive (D), press the minus (-) button to begin switching the feature on.

Press the minus (-) button again to continue locking out higher gears. Beginning with the highest gear, the instrument cluster indicates the current gear and highest gear available. For example, press the minus (-) button twice to lock out 10th and 9th gears.

Note: *The instrument cluster indicates the current gear and highest gear available.*

Press the plus (+) button to unlock gears to allow the transmission to shift to higher gears.

Note: *The transmission automatically shifts within the gear range you select.*

AUTOMATIC TRANSMISSION FLUID CAPACITY AND SPECIFICATION

Automatic Transmission

Note: *Only use transmission fluid that conforms to the defined specification. Use of other fluids could result in vehicle damage not covered by the vehicle warranty.*

Four-Wheel Drive (If Equipped)

HOW DOES FOUR-WHEEL DRIVE WORK - EXCLUDING: TREMOR

Using the Electronic Shift On the Fly System (If Equipped)

This four-wheel drive system utilizes a 2-speed Electronic Shift On the Fly (ESOF) transfer case that is also known as a part-time system. The system operates by a push button control located on the instrument panel that allows you to select 2H (Two-wheel drive high), 4H (Four-wheel drive high) or 4L (Four-wheel drive low). When you select either four-wheel drive high or four-wheel drive low, the system provides mechanically locked four-wheel drive power to both the front and rear wheels for use in off-road or slippery conditions such as deep snow, sand or mud. When you select four-wheel drive low, the system provides additional gearing for increased torque multiplication for conditions like deep sand, steep slopes, or pulling heavy objects. Additionally, the system is capable of recreational flat towing by putting the transfer case into a neutral position. See **Recreationally Towing Your Vehicle** (page 431).

There is further information available on driving in unique driving conditions. See **Off-Road Driving** (page 414).

Hub Lock



Hub Plug



Your vehicle is equipped with a single sided automatic hub lock on the driver side. The passenger side is equipped with a hub plug that is permanently locked and requires no action.

The hub lock should always be set to auto unless your 4x4 does not engage. If your 4x4 does not engage, the hub lock can be manually locked by rotating the hub lock dial clockwise from auto to lock, ensuring the lock arrows align.

Four-Wheel Drive (If Equipped)

Note: The hub plug is always locked and attempting to rotate the dial can result in damage.

Note: If the hub lock is in lock mode while in 4x2, there will be additional noise from the front axle. Driving with the hub manually locked may decrease fuel economy.

HOW DOES FOUR-WHEEL DRIVE WORK - TREMOR

Using the Electronic Shift On the Fly System (If Equipped)

This four-wheel drive system utilizes a 2-speed Electronic Shift On the Fly (ESOF) transfer case that is also known as a part-time system. The system operates by a push button control located on the instrument panel that allows you to select 2H (Two-wheel drive high), 4H (Four-wheel drive high) or 4L (Four-wheel drive Low). When you select either four-wheel drive high or four-wheel drive low, the system provides mechanically locked four-wheel drive power to both the front and rear wheels for use in off-road or slippery conditions such as deep snow, sand or mud. When you select four-wheel drive low, the system provides additional gearing for increased torque multiplication for conditions like deep sand, steep slopes, or pulling heavy objects. Additionally, the system is capable of recreational flat towing by putting the transfer case into a neutral position. See **Recreationally Towing Your Vehicle** (page 431).

There is further information available on driving in unique driving conditions. See **Off-Road Driving** (page 414).

Hub Lock



Your vehicle is equipped with automatic hub locks on both the driver and passenger side. Make sure that both hub locks are set to the same position (both set to lock or both set to auto).

Hub locks should always be set to auto unless your 4x4 does not engage. If your 4x4 does not engage, the hubs can be manually locked by rotating the hub lock dial clockwise from auto to lock, ensuring the lock arrows align.

Note: If hub locks are in lock mode while in 4x2, there will be additional noise from the front axle. Driving with both hubs manually locked may decrease fuel economy.

Four-Wheel Drive (If Equipped)

FOUR-WHEEL DRIVE PRECAUTIONS



WARNING: Vehicles with a higher center of gravity (utility and four-wheel drive vehicles) handle differently than vehicles with a lower center of gravity (passenger cars). Avoid sharp turns, excessive speed and abrupt steering in these vehicles. Failure to drive cautiously increases the risk of losing control of your vehicle, vehicle rollover, personal injury and death.



WARNING: Do not become overconfident in the ability of four-wheel drive vehicles. Although a four-wheel drive vehicle may accelerate better than a two-wheel drive vehicle in low traction situations, it won't stop any faster than two-wheel drive vehicles. Always drive at a safe speed.

Truck and utility vehicles differ from passenger cars. Your vehicle could be higher to allow it to travel over rough terrain without getting stuck or damaging underbody components. The differences that make your vehicle so versatile also make it handle differently than passenger cars. Always maintain steering wheel control, especially in rough terrain. Since sudden changes in terrain can result in abrupt steering wheel motion, make sure you grip the steering wheel from the outside. Do not grip the spokes. Drive cautiously to avoid vehicle damage from concealed objects such as rocks and stumps. Drive slower in strong crosswinds which can affect the normal steering characteristics of your vehicle. Be extremely careful when driving on pavement made slippery by loose sand, water, gravel, snow or ice.

Note: Your vehicle may come with a front air dam that can become damaged (due to reduced ground clearance) when taking your vehicle off-road. To prevent damage, remove the 15 bolts securing the air dam and remove.

FOUR-WHEEL DRIVE LIMITATIONS

Do not use four-wheel drive high or four-wheel drive low mode on dry, hard surface roads. Doing so can produce excessive noise, increase tire wear and can damage drive components. Four-wheel drive high or four-wheel drive low modes are intended for consistently slippery or loose surfaces. Use of four low mode on these surfaces could produce some noise, such as occasional clunks, but should not damage drive components. When transitioning from consistently loose or slippery surfaces, be sure the four-wheel drive system is not mechanically blocked once on dry, hard surface roads in two-wheel drive high.

Note: In certain scenarios, where the four-wheel drive system has difficulty engaging, a **To Engage 4x4 Slow to 3 MPH** or **To Engage 4x4 Slow to 5 km/h** message could appear in the instrument cluster.

Operating Four-Wheel Drive with a Spare or Worn Tires

Your four-wheel drive system is not intended to provide full function with tires that have different levels of wear or with a dissimilar spare tire. Incorrect use of four-wheel drive with such tires can cause system damage.

Four-Wheel Drive (If Equipped)

If there is a difference in the level of wear among tires on the vehicle or if you install a dissimilar spare tire on the vehicle, do not use 4WD High or 4WD Low (if equipped) other than to get your vehicle unstuck. After getting your vehicle unstuck, shift to 2H by performing the following steps:

1. Come to a stop on a flat, horizontal surface
2. Shift the transmission to park (P) for automatic transmissions and neutral (N) for manual transmissions.
3. Switch to two-wheel drive mode.
4. Shift the transmission to reverse (R).
5. Shift the transmission to drive (D) for automatic transmissions and to first gear for manual transmissions. This ensures the transfer case system is not trapped in place.

Note: When the system detects a spare or worn tires and a four-wheel drive engagement request above a designated speed, a warning message appears in the instrument cluster. See **Four-Wheel Drive – Information Messages** (page 238).

Note: In certain scenarios, where the four-wheel drive system has difficulty engaging, a **To Engage 4x4 Slow to 3 MPH** or **To Engage 4x4 Slow to 5 km/h** message could appear in the instrument cluster.

Mechanical Shift Blocking

On four-wheel drive vehicles with a mechanically locked four-wheel drive high mode, the transfer case distributes torque to the front wheels by mechanically interlocking the front and rear driveshafts together. Various external factors affect shifting performance of this type of system including, but not limited to:

- Vehicle acceleration.
- Dissimilar tire sizes.
- Steering input.

If the system detects a mechanical shift blockage at speed after you select two-wheel drive high, the message "4x4 Unable to Disengage See Manual", could display momentarily. If this message displays, one or more of the following actions can relieve the mechanical shift block:

- Momentary acceleration.
- Momentary braking.
- Bringing the vehicle to a stop.
- Shifting the transmission to neutral and back to drive.
- Shifting the transmission to reverse and back to drive.
- Driving the vehicle around a tight turn at a slow speed.

Note: In certain scenarios, where the four-wheel drive system has difficulty engaging, a warning message appears in the instrument cluster. See **Four-Wheel Drive – Information Messages** (page 238).

SWITCHING FOUR-WHEEL DRIVE ON AND OFF

A vehicle that comes with four-wheel drive, when selected, has the ability to use all four wheels to power itself. This increases traction, which may enable you to safely drive over terrain and road conditions that a conventional two-wheel drive vehicle cannot.

On some four-wheel drive models, the initial shift from two-wheel drive to four-wheel drive while the vehicle is moving can cause a momentary clunk and ratcheting sound. These sounds are normal as the front drivetrain comes up to speed and are not cause for concern.

Four-Wheel Drive (If Equipped)

SELECTING A FOUR-WHEEL DRIVE MODE



The drive mode control is on the instrument panel.

Press the four-wheel drive mode button that best fits the current driving conditions. You can select two-wheel drive high (2H) or four-wheel drive high (4H) at a stop or while driving. When the shift is complete, the mode you select appears in the instrument cluster display. While shifting, the lights on the drive mode control can flash and you could see messages in the instrument cluster display indicating that a shift is in progress or to release the accelerator pedal to improve shift performance.

Note: *Momentarily releasing the accelerator pedal while a shift in progress message displays improves engagement or disengagement performance.*

Note: *Do not perform this operation when cruise control or trail control is selected and active. The system may not shift as expected.*

Note: *When the light is solid, the system has achieved the desired four-wheel drive mode. When a selected four-wheel drive mode light is blinking, the system is attempting to shift to that specific four-wheel drive mode.*

Note: *When you achieve recreational towing, all lights are off and Neutral Tow Enabled Leave Transmission in Neutral appears in the instrument cluster display.*

Note: *Do not perform this operation if the rear wheels are slipping, when making a tight turn or when applying the accelerator pedal. The system may not shift as expected.*

Note: *In certain scenarios, where the four-wheel drive system has difficulty engaging, a **To Engage 4x4 Slow to 3 MPH** or **To Engage 4x4 Slow to 5 km/h** message could appear in the instrument cluster.*

Note: *You could hear some noise as the system shifts or engages, this is normal.*

If the system detects a fault, a warning message appears in the instrument cluster display. See **Four-Wheel Drive – Information Messages** (page 238).

Shifting to or from Four-Wheel Drive Low (4L)

To select or exit four-wheel drive low (4L):

1. Bring your vehicle to a speed of 5 km/h (3 mph) or less.
2. Place the transmission in neutral (N)
3. Press the desired four-wheel drive button on the drive mode control.

A message appears in the instrument cluster display indicating a four-wheel drive shift is in progress. If any of the above shift conditions are not present, the shift will not occur and information guiding you through the proper shifting procedures appears in the instrument cluster display.

Four-Wheel Drive (If Equipped)

If there is a transfer case tooth blockage a message appears in the instrument cluster display. To alleviate this condition, place the transmission in a forward gear, move your vehicle forward approximately 1.5 m (5 ft), and shift the transmission back to neutral (N) to allow the transfer case to complete the range shift.

Note: *You could hear some noise as the system shifts or engages, this is normal.*

If the system detects a fault, a warning message appears in the instrument cluster display. See **Four-Wheel Drive – Information Messages** (page 238).

FOUR-WHEEL DRIVE MODES

TWO-WHEEL DRIVE HIGH

Two-wheel drive high is for general on-road driving. Power is sent to the rear wheels only.

Note: *Two-wheel drive high can turn on or off automatically based on Drive Mode selection. See **Drive Mode Control** (page 310).*

FOUR-WHEEL DRIVE HIGH

Four-wheel drive high provides mechanically locked four-wheel drive power to both the front and rear wheels for use in off-road or winter conditions such as deep snow, sand or mud. This mode is not for use on dry pavement.

Note: *Four-wheel drive high can turn on or off automatically based on Drive Mode selection. See **Selecting a Drive Mode** (page 310).*

FOUR-WHEEL DRIVE LOW

Four-wheel drive low provides mechanically locked four-wheel drive power to both the front and rear wheels for use on low traction surfaces, but does so with additional gearing for increased torque multiplication. This mode is only for off-road conditions such as deep sand, steep slopes, or pulling heavy objects.

Note: *Four-wheel drive low can turn on or off automatically based on drive mode selection. See **Selecting a Drive Mode** (page 310).*

FOUR-WHEEL DRIVE INDICATORS

Two-wheel Drive High

2H Momentarily illuminates when you select two-wheel drive high.

Four-wheel Drive High

4H Continuously illuminates when you select four-wheel drive high.

Four-wheel Drive Low

4L Continuously illuminates when you select four-wheel drive low.

TRANSFER CASE FLUID CAPACITY AND SPECIFICATION

Use fluid that meets the defined specification.

Four-Wheel Drive (If Equipped)

If you do not use fluid that meets the defined specification, it could result in:

- Component damage that your vehicle warranty does not cover.
- Reduced vehicle performance.

Capacities

Variant	Quantity
All.	1.8 L (1.9 qt)

Materials

Name	Specification
Motorcraft® MERCON® LV Automatic Transmission Fluid (U.S.) Motorcraft® MERCON® LV Automatic Transmission Fluid / Huile pour boîte automatique MERCON® LV Motorcraft® (Canada) XT-10-QLVC (U.S.) CXT-10-LV6 (Canada)	WSS-M2C938-A

FOUR-WHEEL DRIVE – TROUBLESHOOTING

FOUR-WHEEL DRIVE – WARNING LAMPS



Illuminates when a four-wheel drive or power train fault is present.

Note: When a system fault is present, the system can typically remain in whichever mode was selected prior to the fault condition occurring. It does not default to two-wheel drive in all circumstances. When this warning displays, have your vehicle serviced by an authorized dealer.

Four-Wheel Drive (If Equipped)

FOUR-WHEEL DRIVE – INFORMATION MESSAGES

Message	Action
Check 4x4	A four-wheel drive system fault is present. Have the system checked as soon as possible.
4x4 Shift in Progress	The four-wheel drive system is making a shift.
For 4x4 LOW Shift to N	Displays when you attempt to switch to four-wheel drive low mode and you do not shift the transmission to neutral (N).
For 4x4 LOW Slow to 3 MPH	Displays when you attempt to switch to four-wheel drive low mode and your vehicle's speed is greater than 5 km/h (3 mph).
For 4x4 LOW Slow to 5 km/h	
To Exit 4x4 LOW Shift to N	Displays when you attempt to switch from four-wheel drive low mode and you do not shift the transmission to neutral (N).
To Exit 4x4 LOW Slow to 3 MPH	Displays when you attempt to switch from four-wheel drive low mode and your vehicle's speed is greater than 5 km/h (3 mph).
To Exit 4x4 LOW Slow to 5 km/h	
Shift Delayed Drive Forward	Displays when there is a transfer case gear tooth blockage while shifting to or from four-wheel drive low mode or to the neutral state. Place the transmission in a forward gear, move your vehicle forward approximately 1.5 m (5 ft), and shift the transmission back to neutral (N) to allow the transfer case to complete the range shift.
Shift to Neutral	Displays when the system requires an additional transmission shift to neutral (N) to complete a transfer case shift.
To Engage 4x4 Slow to 3 MPH	Displays when the system is unable to engage four-wheel drive high and requires the driver to slow down before attempting to engage.

Four-Wheel Drive (If Equipped)

Message	Action
To Engage 4x4 Slow to 5 km/h	
To Engage 4x4 Release Accelerator Pedal	Displays when the four-wheel drive system requests that you release the accelerator pedal to complete a four-wheel drive shift. See Selecting a Four-Wheel Drive Mode (page 235).
4x4 Unable to Disengage See Manual	Displays when the four-wheel drive system detects a mechanical shift block when shifting out of four-wheel drive high. See Four-Wheel Drive Limitations (page 233).

FOUR-WHEEL DRIVE VIDEOS

[4-Wheel-Drive Systems Video Link](#)

Front Axle

FRONT AXLE FLUID CAPACITY AND SPECIFICATION

Use fluid that meets the defined specification and viscosity grade.

If you do not use fluid that meets the defined specification and viscosity grade, it could result in:

- Component damage that your vehicle warranty does not cover.
- Reduced vehicle performance.

Front Axle-9.25

Capacities

Variant	Quantity
Four-wheel drive without limited slip.	2.08 L (2.20 qt)
Four-wheel drive with limited slip.	2.08 L (2.20 qt) ¹

¹For complete refill of limited slip axles, add 4.4 fl oz. (130 ml) of Additive Friction Modifier XL-3 or equivalent, meeting specification EST-M2C118-A. Include this friction modifier in the total lube volume of 2.2 qt (2.08 L).

Materials

Name	Specification
Motorcraft® Additive Friction Modifier(U.S.) Motorcraft® Additive Friction Modifier / Additif modificateur de friction Motorcraft®(Canada) XL-3(U.S. & Canada)	EST-M2C118-A
Motorcraft® SAE 80W-90 Premium Rear Axle Lubricant(U.S.) Motorcraft® SAE 80W-90 Premium Axle Lubricant / Lubrifiant pour essieux de très haute qualité SAE 80W-90 Motorcraft®(Canada) XY-80W90-QL(U.S.) CXY-80W90-1L(Canada)	WSP-M2C197-A

Front Axle-10.08

Capacities

Variant	Quantity
All.	2.6 L (2.75 qt)

Front Axle

Materials

Name	Specification
Motorcraft® SAE 80W-90 Premium Rear Axle Lubricant (U.S.) Motorcraft® SAE 80W-90 Premium Axle Lubricant / Lubrifiant pour essieux de très haute qualité SAE 80W-90 Motorcraft® (Canada) XY-80W90-QL (U.S.) CXY-80W90-1L (Canada)	WSP-M2C197-A

Rear Axle

LIMITED SLIP DIFFERENTIAL

(IF EQUIPPED)

This axle provides added traction on slippery surfaces, particularly when one wheel is on a poor traction surface. Under normal conditions, the limited-slip axle functions like a standard rear axle. The axle may exhibit a slight noise or vibration during tight turns with low vehicle speed. This is normal behavior and indicates the axle is working.

REAR AXLE FLUID CAPACITY AND SPECIFICATION

Use fluid that meets the defined specification and viscosity grade.

If you do not use fluid that meets the defined specification and viscosity grade, it could result in:

- Component damage that your vehicle warranty does not cover.
- Reduced vehicle performance.

Rear Axle - 10.5

Capacities

Variant	Quantity
With electronic locking differential.	3.1–3.3 L (3.3–3.5 qt)
Without electronic locking differential.	3.3–3.4 L (3.5–3.6 qt)

Materials

Name	Specification
Motorcraft® SAE 75W-85 Premium Synthetic Hypoid Gear Lubricant (U.S.) Motorcraft® SAE 75W-85 Premium Synthetic Hypoid Gear Lubricant / Huile synthétique de haute qualité pour engrenages hypoides SAE 75W-85 Motorcraft® (Canada) XY-75W85-QL (U.S. & Canada)	WSS-M2C942-A

Rear Axle

Rear Axle - 10.8

Capacities

Variant	Quantity
Open Differential Oil Only.	3.48 L (3.68 qt)
Limited Slip Differential Oil.	3.271 L (3.46 qt) ¹

¹ For complete refill of limited slip axles, add 7.06 fl oz. (208.8 ml) of Additive Friction Modifier XL-3 or equivalent, meeting Ford Specification EST-M2C118-A.

Materials

Name	Specification
Motorcraft® Additive Friction Modifier(U.S.) Motorcraft® Additive Friction Modifier / Additif modificateur de friction Motorcraft®(Canada) XL-3(U.S. & Canada)	EST-M2C118-A
Motorcraft® SAE 75W-140 Synthetic Rear Axle Lubricant(U.S.) Motorcraft® SAE 75W-140 Synthetic Rear Axle Lubricant / Lubrifiant synthétique pour pont arrière SAE 75W-140 Motorcraft®(Canada) XY-75W140-QL(U.S.) CXY-75W140-1L(Canada)	WSL-M2C192-A

Rear Axle - 11.6

Capacities

Variant	Quantity
4.30 final Drive ratio .	4.2–4.3 L (4.44–4.54 qt)
All other final Drive ratios (3.31/3.55/3.73).	4.1–4.2 L (4.33–4.44 qt)

Rear Axle

Materials

Name	Specification
Motorcraft® SAE 75W-140 Synthetic Rear Axle Lubricant(U.S.) Motorcraft® SAE 75W-140 Synthetic Rear Axle Lubricant / Lubrifiant synthétique pour pont arrière SAE 75W-140 Motorcraft®(Canada) XY-75W140-QL(U.S.) CXY-75W140-1L(Canada)	WSL-M2C192-A

Rear Axle - 11.8 Light Duty and Heavy Duty

Capacities

Variant	Quantity
Open Differential Oil Only.	3.98 L (4.21 qt)
Limited Slip Differential Oil.	3.741 L (3.95 qt) ¹

¹ For complete refill of limited slip axles, add 8.07 fl oz. (238.8 ml) of Additive Friction Modifier XL-3 or equivalent, meeting Ford Specification EST-M2C118-A.

Materials

Name	Specification
Motorcraft® Additive Friction Modifier(U.S.) Motorcraft® Additive Friction Modifier / Additif modificateur de friction Motorcraft®(Canada) XL-3(U.S. & Canada)	EST-M2C118-A
Motorcraft® SAE 75W-140 Synthetic Rear Axle Lubricant(U.S.) Motorcraft® SAE 75W-140 Synthetic Rear Axle Lubricant / Lubrifiant synthétique pour pont arrière SAE 75W-140 Motorcraft®(Canada) XY-75W140-QL(U.S.) CXY-75W140-1L(Canada)	WSL-M2C192-A

Rear Axle

Rear Axle - 11.8 Single Rear Wheel

Capacities

Variant	Quantity
Electric Locking Differential Oil Only.	3.83 L (4.05 qt)

Materials

Name	Specification
Motorcraft® Additive Friction Modifier(U.S.) Motorcraft® Additive Friction Modifier / Additif modificateur de friction Motorcraft®(Canada) XL-3(U.S. & Canada)	EST-M2C118-A
Motorcraft® SAE 75W-140 Synthetic Rear Axle Lubricant(U.S.) Motorcraft® SAE 75W-140 Synthetic Rear Axle Lubricant / Lubrifiant synthétique pour pont arrière SAE 75W-140 Motorcraft®(Canada) XY-75W140-QL(U.S.) CXY-75W140-1L(Canada)	WSL-M2C192-A

Rear Axle - 12.4

Capacities

Variant	Quantity
Limited Slip Differential Oil.	4.399 L (4.65 qt) ¹

¹ For complete refill of limited slip axles, add 9.49 fl oz. (280.8 ml) of Additive Friction Modifier XL-3 or equivalent, meeting Ford Specification EST-M2C118-A.

Rear Axle

Materials

Name	Specification
Motorcraft® Additive Friction Modifier(U.S.) Motorcraft® Additive Friction Modifier / Additif modificateur de friction Motorcraft®(Canada) XL-3(U.S. & Canada)	EST-M2C118-A
Motorcraft® SAE 75W-140 Synthetic Rear Axle Lubricant(U.S.) Motorcraft® SAE 75W-140 Synthetic Rear Axle Lubricant / Lubrifiant synthétique pour pont arrière SAE 75W-140 Motorcraft®(Canada) XY-75W140-QL(U.S.) CXY-75W140-1L(Canada)	WSL-M2C192-A

Electronic Locking Differential (If Equipped)

WHAT IS THE ELECTRONIC LOCKING DIFFERENTIAL

The electronic locking differential is a device housed in the rear axle and when activated, allows both wheels on that axle to turn at the same speed. The electronic locking differential provides additional traction should your vehicle become stuck.

HOW DOES THE ELECTRONIC LOCKING DIFFERENTIAL WORK

You can activate the differential electronically and shift it on the fly within the operating speed range. The electronic differential disengages when the vehicle speed exceeds a set value and it reengages when the vehicle speed drops below a set value. See **Switching the Electronic Locking Differential On and Off** (page 247). The electronic locking differential could engage based on certain selected drive modes. See **Selecting a Drive Mode** (page 310). The electronic locking differential is for use in mud, rocks, sand, or any off-road condition where you need maximum traction.

Note: *The electronic locking differential is for off-road use only and is not for use on dry pavement. Using the electronic locking differential on dry pavement results in increased tire wear, noise and vibration.*

Note: *The electronic locking differential activates or deactivates automatically based on speed, four-wheel drive mode, and drive mode selection. See **Switching the Electronic Locking Differential On and Off** (page 247).*

ELECTRONIC LOCKING DIFFERENTIAL PRECAUTIONS

Operating the Electronic Locking Differential with a Spare or Mismatched Tires

On vehicles with an electronic locking differential, the size of the spare tire can affect performance of the system. If there is a significant difference between the two rear tires, you may have limited electronic locking differential functionality. If the system has difficulty disengaging, release the accelerator pedal and turn the steering wheel in the opposite direction when rolling. We recommend engaging and disengaging the electronic locking differential at a stop when you mount a spare on the rear axle.

SWITCHING THE ELECTRONIC LOCKING DIFFERENTIAL ON AND OFF - 4X4

Press the electronic lock differential switch to engage and disengage the locking differential.



Electronic Locking Differential (If Equipped)

4X4 Rear Electronic Locking Differential Engagement Speed and Availability

Drive Modes	Maximum Engagement Speed	Automatic Disengagement Speed	Automatic Re-Engagement Speed
Eco (2H, 4H)	30 km/h (20 mph)	41 km/h (25 mph)	30 km/h (20 mph)
Tow/Haul Mode (2H,4H)	30 km/h (20 mph)	41 km/h (25 mph)	30 km/h (20 mph)
Normal (2H, 4H)	30 km/h (20 mph)	41 km/h (25 mph)	30 km/h (20 mph)
Slippery (2H, 4H)	30 km/h (20 mph)	41 km/h (25 mph)	30 km/h (20 mph)
Off-Road (4H, 4L) ¹	No Speed Limit	No Speed Limit	No Speed Limit
Rock Crawl (4L) ²	No Speed Limit	No Speed Limit	No Speed Limit

¹ Engages when you select these drive modes. You have the ability to manually override the automatic engagement by pressing the electronic locking differential.

² Engages when you select these drive modes. You have the ability to manually override the automatic engagement by pressing the electronic locking differential. Only available with Tremor Package.

4WD Mode	Maximum Engagement Speed	Automatic Disengagement Speed	Automatic Re-Engagement Speed
Four-Wheel Drive Low (4L)	No Speed Limit	No Speed Limit	No Speed Limit

Note: The electronic locking differential may not engage if you press the accelerator pedal during an engagement attempt. A message could display in the instrument cluster display guiding you to release the accelerator pedal.

Note: Switching the electronic locking differential off while turning results in disengagement difficulties. If the electronic locking differential has difficulty disengaging, release the accelerator pedal and turn the steering wheel back and forth in small increments while maintaining control and following a straight line.

Note: The electronic locking differential is for off-road use only and is not for use on dry pavement. Using the electronic locking differential on dry pavement results in increased tire wear, noise and vibration.

Note: Do not perform this operation when cruise control or trail control is selected and active. The system may not engage or disengage as expected.

Electronic Locking Differential (If Equipped)

SWITCHING THE ELECTRONIC LOCKING DIFFERENTIAL ON AND OFF - 4X2

Press the electronic locking differential switch to engage and disengage the electronic locking differential.

4X2 Rear Electronic Locking Differential Engagement Speed and Availability

Maximum Engagement Speed	Automatic Disengagement Speed	Automatic Re-Engagement Speed
30 km/h (20 mph)	41 km/h (25 mph)	30 km/h (20 mph)

Note: The electronic locking differential can activate or deactivate automatically based on speed, four-wheel drive mode, and drive mode selection. See **Selecting a Drive Mode** (page 310).



Note: The electronic locking differential may not engage if you press the accelerator pedal during an engagement attempt. A message could display in the instrument cluster display guiding you to release the accelerator pedal.

Note: Switching the electronic locking differential off while turning results in disengagement difficulties. If the electronic locking differential has difficulty disengaging, release the accelerator pedal and turn the steering wheel back and forth in small increments while maintaining control and following a straight line.

Note: The electronic locking differential is for off-road use only and is not for use on dry pavement. Using the electronic locking differential on dry pavement results in increased tire wear, noise and vibration.

Note: Do not perform this operation when cruise control or trail control is selected and active. The system may not engage or disengage as expected.

ELECTRONIC LOCKING DIFFERENTIAL INDICATORS



If both rear wheel axle shafts lock together, the indicator in the cluster is amber, providing additional traction.

If you select the electronic locking differential and the indicator in the cluster is gray or turns from amber to gray while driving, one of the following has occurred:

- The vehicle speed is too high.
- The accelerator pedal is too high during an engagement attempt.
- The vehicle is experiencing an anti-lock brake activation.
- The left and right wheel speed difference is too high during an engagement attempt.

If you select the electronic locking differential and the indicator in the cluster does not turn on, the following has occurred:

Electronic Locking Differential (If Equipped)

- The system has malfunctioned and accompanies a check locking differential message in the information display. See your dealer as soon as possible.

Note: *If the vehicle is experiencing an anti-lock braking event, the electronic locking differential may momentarily disengage.*

ELECTRONIC LOCKING DIFFERENTIAL – TROUBLESHOOTING

ELECTRONIC LOCKING DIFFERENTIAL – INFORMATION MESSAGES

Message	Description and Action
Check Locking Differential	An electronic locking differential system fault is present. Contact an authorized dealer as soon as possible.
To Engage Locking Differential Release Accelerator Pedal	Release the accelerator pedal to engage.

Brakes

BRAKE PRECAUTIONS

Wet brakes result in reduced braking efficiency. Gently press the brake pedal a few times when leaving a car wash or driving from standing water to dry the brakes.

Note: *Depending on applicable laws and regulations in the country for which your vehicle was originally built, your brake lamps may flash during heavy braking. Following this, your hazard lights may also flash when your vehicle comes to a stop.*

ANTI-LOCK BRAKING SYSTEM

ANTI-LOCK BRAKING SYSTEM LIMITATIONS

The anti-lock braking system does not eliminate the risk of crash when:

- You drive too closely to the vehicle in front of you.
- Your vehicle is hydroplaning.
- You take corners too fast.
- The road surface is poor.

Note: *If the system activates, the brake pedal could pulse and travel further. Maintain pressure on the brake pedal.*

BRAKE OVER ACCELERATOR

In the event the accelerator pedal becomes stuck or entrapped, apply steady and firm pressure to the brake pedal to slow the vehicle and reduce engine power. If you experience this condition, apply the brakes and bring your vehicle to a safe stop. Move the transmission to park (P), switch the engine off and apply the parking brake. Inspect the accelerator pedal for any interference. If none are found and the condition persists, have your vehicle towed to the nearest authorized dealer.

LOCATING THE BRAKE FLUID RESERVOIR

See **Under Hood Overview** (page 446).

CHECKING THE BRAKE FLUID



WARNING: Do not use any fluid other than the recommended brake fluid as this will reduce brake efficiency. Use of incorrect fluid could result in the loss of vehicle control, serious personal injury or death.



WARNING: Only use brake fluid from a sealed container. Contamination with dirt, water, petroleum products or other materials may result in brake system damage or failure. Failure to adhere to this warning could result in the loss of vehicle control, serious personal injury or death.



WARNING: Do not allow the fluid to touch your skin or eyes. If this happens, rinse the affected areas immediately with plenty of water and contact your physician.



WARNING: The brake system could be affected if the brake fluid level is below the **MIN** mark or above the **MAX** mark on the brake fluid reservoir.

1. Park your vehicle on a level surface.

Brakes



2. Look at the brake fluid reservoir to see where the brake fluid level is relative to the **MIN** and the **MAX** marks on the reservoir.

Note: To avoid fluid contamination, the reservoir cap must remain in place and fully tight, unless you are adding fluid.

Only use fluid that meets our specifications. See **Brake Fluid Specification** (page 252).

BRAKE FLUID SPECIFICATION

See **Brake Fluid Specification** (page 252).

BRAKES – TROUBLESHOOTING

BRAKES – WARNING LAMPS



WARNING: Driving your vehicle with the warning lamp on is dangerous. A significant decrease in braking performance may occur. It may take you longer to stop your vehicle. Have your vehicle checked as soon as possible. Driving extended distances with the parking brake engaged can cause brake failure and the risk of personal injury.



If the ABS indicator illuminates when you are driving, this indicates a malfunction. Your vehicle continues to have normal braking without the anti-lock braking system function. See an authorized dealer.

It also momentarily illuminates when you switch the ignition on to confirm the lamp is functional. If it does not illuminate when you switch the ignition on, or begins to flash at any time, have the system checked by an authorized dealer.

BRAKE



The brake indicator momentarily illuminates when you switch the ignition on to confirm the lamp is functional. It may also illuminate when you apply the parking brake and the ignition is on. If it illuminates when your vehicle is moving, make sure the parking brake is disengaged. If the parking brake is disengaged, this indicates low brake fluid level or a brake system fault. See an authorized dealer.

Note: Lamps may vary depending on region.

Brakes

BRAKES – INFORMATION MESSAGES

Message	Details
Brake Fluid Level Low	The brake fluid level is low, check the brake system immediately. See Checking the Brake Fluid (page 251).
Check Brake System	Have the system checked as soon as possible.

Brakes

BRAKES – FREQUENTLY ASKED QUESTIONS

Is it normal for my brakes to make noise?

Occasional brake noise is normal. If a metal-to-metal, continuous grinding, or squeal sound is present, the brake lining could be worn. Have the system checked.

There is an electrical motor sound when I press on the brake pedal or activate the park brake switch. Is this normal?

Yes, those sounds are the electronic brake booster or the electronic park brake operating.

Note: *Brake dust could accumulate on the wheels, even under normal driving conditions. Some dust is normal as the brakes wear and does not contribute to brake noise. See **Cleaning Wheels** (page 490).*

Electric Parking Brake

WHAT IS THE ELECTRIC PARKING BRAKE

The electric parking brake is used to hold your vehicle on slopes and flat roads.

APPLYING THE ELECTRIC PARKING BRAKE



WARNING: Apply the parking brake, shift into park (P), switch the ignition off and remove the key before you leave your vehicle. Failure to follow this instruction could result in personal injury or death.



WARNING: If you drive extended distances with the parking brake applied, you could cause damage to the brake system.



WARNING: The electric parking brake does not operate if the vehicle battery has run out of charge.



WARNING: If the parking brake is fully released, but the brake warning lamp remains illuminated, the brakes may not be working properly. Have your vehicle checked as soon as possible.



The switch is on the lower part of the instrument panel.

Pull the switch up to apply the electric parking brake. The red warning lamp flashes, then steadily illuminates when the parking brake is applied.

Note: You can apply the electric parking brake when the ignition is off.

Note: The electric parking brake could automatically apply when park (P) is selected. See **Park (P)** (page 226).

APPLYING THE ELECTRIC PARKING BRAKE IN AN EMERGENCY

You can use the electric parking brake to slow or stop your vehicle in an emergency. Pull the switch up and hold it.

The red warning lamp illuminates, a tone sounds and the stoplamps turn on when you use the electric parking brake in an emergency.

The electric parking brake continues to slow your vehicle down unless you release the switch.

Note: Do not apply the electric parking brake when your vehicle is moving, except in an emergency. If you repeatedly use the electric parking brake to slow or stop your vehicle, you could cause damage to the brake system.

MANUALLY RELEASING THE ELECTRIC PARKING BRAKE

1. Switch the ignition on.
2. Press and hold the brake pedal.
3. Push the switch down.

The red warning lamp turns off.

Pulling Away When Towing a Trailer Uphill

1. Press and hold the brake pedal.
2. Pull the switch upward and hold it.
3. Shift into gear.
4. Press the accelerator pedal until engine has developed sufficient torque to prevent your vehicle from rolling down the hill.
5. Release the switch and pull away in a normal manner.

Electric Parking Brake

AUTOMATICALLY RELEASING THE ELECTRIC PARKING BRAKE

1. Close the driver door.
2. Shift into gear.
3. Press the accelerator pedal and pull away in a normal manner.

ELECTRIC PARKING BRAKE AUDIBLE WARNING

Sounds when the parking brake is on and your vehicle is moving. If the warning tone continues after you have released the parking brake, this indicates a malfunction. Have your vehicle checked as soon as possible.

RELEASING THE ELECTRIC PARKING BRAKE IF THE VEHICLE BATTERY HAS RUN OUT OF CHARGE



WARNING: The electric parking brake does not operate if the vehicle battery has run out of charge.

Connect a booster battery to the vehicle battery to release the electric parking brake if the vehicle battery has run out of charge. See **Jump Starting the Vehicle** (page 425).

ELECTRIC PARKING BRAKE – TROUBLESHOOTING

ELECTRIC PARKING BRAKE – WARNING LAMPS

Brake System



It illuminates red when you apply the parking brake and your vehicle is on. If the lamp flashes when the parking brake has been released, this indicates the parking brake system requires service. Have your vehicle checked as soon as possible.



Note: Lamps may vary depending on region.

Electric Parking Brake



When the lamp illuminates yellow, it indicates a malfunction in the electric parking brake. Have your vehicle checked as soon as possible.



Note: Lamps may vary depending on region.

Electric Parking Brake

ELECTRIC PARKING BRAKE – INFORMATION MESSAGES

Message	Action
To Release: Press Brake and Switch	The electric parking brake is set and a manual release is attempted without the brake pedal being pressed.
Park Brake Use Switch to Release	The electric parking brake is set and an automatic release is attempted but cannot be performed. Perform a manual release.
Release Park Brake	The electric parking brake is set and your vehicle speed exceeds 5 km/h (3 mph). Release the electric parking brake before continuing to drive.
Park Brake Not Applied	The electric parking brake is not fully applied.
Park Brake Not Released	The electric parking brake is not fully released.
Brake maintenance mode	The electric parking brake system has been put into a special mode to allow brake service. Have the system checked as soon as possible.
Park Brake Limited Function Service Required	The electric parking brake system has detected a condition that requires service. Some functionality may still be available. Have the system checked as soon as possible.
Park Brake Malfunction Service Now	The electric parking brake system has detected a condition that requires service. Have the system checked as soon as possible.

Diesel Engine Exhaust Brake

DIESEL ENGINE EXHAUST BRAKE – PRECAUTIONS



WARNING: Do not use tow/haul when the road surface is slippery. Failure to follow this instruction could result in the loss of control of your vehicle.



WARNING: Do not use diesel engine exhaust braking when the road surface is slippery. Failure to follow this instruction could result in the loss of control of your vehicle.

USING THE DIESEL ENGINE EXHAUST BRAKE

This feature increases engine braking at higher engine speeds to provide better grade descent control with less brake and transmission wear and tear.

Note: Use this when driving downhill and carrying heavy loads or trailering.

Benefits of engine braking are:

- Lower brake temperature.
- Reduced brake fade.
- Longer brake life.
- Improved driving and trailering control.



Press the engine brake button above the touchscreen to switch the system on or off.

There are two engine brake modes, manual and automatic.

The following conditions must be met to use exhaust brake:

- Your vehicle is in a forward gear.
- The engine speed is above 1300 RPM.
- Your foot is off the accelerator.

You can use this feature with tow/haul or progressive range selection to provide further increased engine braking. The transmission upshifts to prevent the engine from entering the red zone on the tachometer.

Manual Engine Braking

1. Press the button to switch on manual engine braking.
2. Release the accelerator pedal to maximize engine braking.
3. Apply the brakes. The transmission downshifts to lower gears.

Note: The engine braking feature only functions when you release the accelerator.

Note: You can shift the transmission to lower gears with progressive range selection or manual shifting independent of pressing the brakes.

Note: You can also use manual engine braking with cruise control to improve grade descent control.

Note: If your vehicle has adaptive cruise control, the speed control system uses the selected engine brake mode, transmission gears, and brakes to maintain the set speed and distance to the vehicle being followed.

Automatic Engine Braking

1. Press the button twice to switch on automatic engine braking.
2. Release the accelerator or brake pedal. The system remembers your vehicle speed.

Diesel Engine Exhaust Brake

Note: This feature offers smoother, less aggressive engine braking during downhill descents. It may not apply engine braking if the vehicle speed is not increasing, although it applies full engine braking force when needed to prevent acceleration. The system automatically activates the engine brake and, if necessary, downshifts the transmission to lower gears to not exceed your vehicle's set speed when the brake or accelerator were last released.

DIESEL ENGINE EXHAUST BRAKE INDICATORS



DIESEL ENGINE EXHAUST BRAKE GAUGE

Displays the diesel engine exhaust brake power in the form of a percentage. A full fill or 100% represents the total diesel engine exhaust brake power available.

The gauge displays zero to 100% depending on the engine brake power provided by the system.

Note: When the diesel engine exhaust brake is switched off, the gauge displays zero.

Accessing the Diesel Engine Exhaust Brake Gauge

You can access the diesel engine exhaust brake gauge in the instrument cluster using the instrument cluster display control on the steering wheel:

- Press the menu button.
- Select **Gauges**.
- Select **Diesel Gauges**.

DIESEL ENGINE EXHAUST BRAKE – TROUBLESHOOTING

DIESEL ENGINE EXHAUST BRAKE – WARNING LAMPS

- Illuminates when this feature is switched on and the system is operating properly.
- Flashes when the engine brake is disabled due to a fault.
- Does not illuminate when the switch or indicator is faulty.

You can switch the system on at any time. The braking system becomes active once the braking conditions are met.

Reverse Brake Assist (If Equipped)

WHAT IS REVERSE BRAKE ASSIST

Reverse brake assist is designed to reduce impact damage or assist in avoiding a collision while in reverse (R).

HOW DOES REVERSE BRAKE ASSIST WORK

Reverse brake assist functions when in reverse (R) and traveling at a speed of 2–12 km/h (1–7 mph).

If the system detects an obstacle behind your vehicle, it provides a warning through the rear parking aid or cross traffic alert system. Using sensors on the rear of the vehicle, it can detect a possible collision and apply the brakes. If full braking occurs, the system attempts to stop the vehicle a safe distance from the obstacle.

REVERSE BRAKE ASSIST PRECAUTIONS



WARNING: You are responsible for controlling your vehicle at all times. The system is designed to be an aid and does not relieve you of your responsibility to drive with due care and attention. Failure to follow this instruction could result in the loss of control of your vehicle, personal injury or death.



WARNING: To help avoid personal injury, always use caution when in reverse (R) and when using the sensing system.



WARNING: The system may not operate properly during severe weather conditions, for example snow, ice, heavy rain and spray. Always drive with due care and attention. Failure to take care may result in a crash.



WARNING: Traffic control systems, fluorescent lamps, inclement weather, air brakes, external motors and fans may affect the correct operation of the sensing system. This may cause reduced performance or false alerts.



WARNING: Some situations and objects prevent hazard detection. For example low or direct sunlight, inclement weather, unconventional vehicle types, and pedestrians. Apply the brakes when necessary. Failure to follow this instruction could result in the loss of control of your vehicle, personal injury or death.



WARNING: Do not use the system with accessories that extend beyond the front or rear of your vehicle, for example a trailer hitch or bike rack. The system is not able to make corrections for the additional length of the accessories.

The system only applies the brakes for a short period of time when an event occurs. Act as soon as you notice the brakes apply to remain in control of the vehicle. If you do not intervene the vehicle may start to move again.

Note: *Certain add-on devices around the bumper or fascia may create false alerts. For example, large trailer hitches, bicycle or surfboard racks, license plate brackets, bumper covers or any other device that may block the normal detection zone of the system. Remove the add-on device to prevent false alerts.*

Reverse Brake Assist (If Equipped)

Note: The system does not react to small or moving objects, particularly those close to the ground.

Note: The system does not operate during hard acceleration or steering.

Note: If your vehicle sustains damage to the bumper or fascia leaving it misaligned or bent, it could alter the sensing zone causing inaccurate measurement of obstacles or false alerts.

Note: Vehicle loading and suspension changes can impact the angle of the sensors and may change the normal detection zone of the system resulting in inaccurate measurement of obstacles or false alerts.

Note: When you connect a trailer, the system may detect the trailer and provide an alert, or the system turns off. If the system does not turn off, manually switch the system off after you connect the trailer.

Note: You may experience reduced system performance on road surfaces that limit deceleration. For example, roads with ice, loose gravel, mud or sand.

SWITCHING REVERSE BRAKE ASSIST ON AND OFF

1. From the driver assistance menu, press Reverse Brake Assist. See **Driver Assistance Menu** (page 560).

2. Switch the feature on or off.

Note: The system is unavailable when the rear parking aid or cross traffic alert is off.

Note: If your vehicle is not equipped with cross traffic alert, the reverse brake assist relies on input from only the rear parking aid and rear camera sensors.

OVERRIDING REVERSE BRAKE ASSIST

There could be instances when unexpected or unwanted braking occurs. Firmly pressing the accelerator pedal or switching the feature off overrides the system.

REVERSE BRAKE ASSIST INDICATORS

If the system determines that a collision with an obstacle may occur, full braking may apply.



A message and warning indicator appear when the system applies the brakes.

Reverse Brake Assist (If Equipped)

REVERSE BRAKE ASSIST – TROUBLESHOOTING

REVERSE BRAKE ASSIST – INFORMATION MESSAGES

Message	Description
Reverse Brake Assist	Displays for a few seconds when the system applies the brakes.
Reverse Brake Assist Not Available See Manual	Displays when a related system or feature error occurs. Make sure the exterior cameras are clean and not obstructed. Drive the vehicle on a straight road for a short period. If the message remains, have the system checked as soon as possible.
Reverse Brake Assist Fault	Displays when a system error has occurred. Have your vehicle checked as soon as possible.
Reverse Brake Assist Off	Displays when reverse brake assist is off.

Reverse Brake Assist (If Equipped)

REVERSE BRAKE ASSIST – FREQUENTLY ASKED QUESTIONS

Why is reverse brake assist unavailable?

- Make sure you switch the system on. See **Switching Reverse Brake Assist On and Off** (page 261).
- Make sure that the liftgate or tailgate, hood and all doors are closed.
- Make sure the cross traffic alert system is on. See **What Is Cross Traffic Alert** (page 334).
- Make sure the rear parking aid system is on. See **What is the Rear Parking Aid** (page 281).
- Make sure that traction control is on. See **Switching Traction Control On and Off** (page 265).
- Your vehicle may have sustained a rear end impact. Have the sensors checked for proper coverage and operation.
- Make sure the exterior cameras are not dirty or obstructed. If dirty, clean the cameras. If the reverse brake assist unavailable message still appears after cleaning the cameras, wait a short time for the message to clear. If the message does not clear, drive the vehicle on a straight road for a short period. If the message remains, have the system checked.
- Make sure the sensors are not blocked or faulted. See **Locating the Rear Parking Aid Sensors** (page 281). See **Locating the Cross Traffic Alert Sensors** (page 336).

- You recently had your vehicle serviced, or the battery disconnected. Drive your vehicle a short distance to resume system operation.
- The system does not function when you connect a trailer. Operation resumes when you disconnect the trailer.

Note: *If you are still having problems with reverse brake assist, have the system checked as soon as possible.*

Hill Start Assist

WHAT IS HILL START ASSIST

Hill Start Assist applies the brakes to hold your vehicle after you bring it to a stop on a slope. This makes it easier for you to pull away without using the parking brake.

HOW DOES HILL START ASSIST WORK

When the system activates, your vehicle remains stationary for a few seconds after you release the brake pedal. This gives you time to move your foot from the brake pedal to the accelerator pedal. The brakes release when you apply the accelerator pedal and the vehicle begins to move forward, or the system exceeds the time allowed for automatically applying the brakes.

The system activates when your vehicle is in any forward gear and facing uphill, or when your vehicle is in reverse (R) and facing downhill.

HILL START ASSIST PRECAUTIONS



WARNING: The system does not replace the parking brake. When you leave your vehicle, always apply the parking brake.



WARNING: You must remain in your vehicle when the system turns on. At all times you are responsible for controlling your vehicle, supervising the system, and intervening if required. Failure to follow this instruction could result in the loss of control of your vehicle, personal injury or death.



WARNING: The system turns off if there is a malfunction.

SWITCHING HILL START ASSIST ON AND OFF

Hill start assist is active when you switch the ignition on. You cannot switch the system on or off.

HILL START ASSIST – TROUBLESHOOTING

HILL START ASSIST – INFORMATION MESSAGES

Message	Details
Hill Start Assist Not Available	Displays when system is not available. Have your vehicle checked as soon as possible.

HILL START ASSIST VIDEOS

[Hill Start Assist](#)

Traction Control

WHAT IS TRACTION CONTROL

The traction control system helps to avoid drive wheel spin and loss of traction.

HOW DOES TRACTION CONTROL WORK

If your wheels begin to spin, the loss of traction can compromise steering control and stability of the vehicle. The traction control system applies the brakes to individual wheels and when needed, reduces engine power at the same time to increase traction.

SWITCHING TRACTION CONTROL ON AND OFF



WARNING: Operating your vehicle with the traction control disabled could lead to an increased risk of loss of vehicle control, vehicle rollover, personal injury and death.



The traction control system turns on each time you switch the ignition on.

The button for the stability and traction control system is on the instrument panel.

Press and release the button to switch traction control off. The stability control system remains fully active, to switch it off, press and hold the button for a few seconds, then release.

When you switch traction control off, a message and an illuminated icon appear on the instrument cluster.

Press the switch again to turn the traction control system back on to normal operation.

If your vehicle is stuck in mud or snow, switching traction control off may be beneficial as this allows the wheels to spin.

TRACTION CONTROL INDICATOR

Stability and Traction Control Indicator



If the indicator does not illuminate when you switch the ignition on, or remains on when the engine is running, this indicates a malfunction. Have your vehicle checked by an authorized dealer as soon as possible.



The traction control off indicator illuminates when you switch the traction control system off, or when an alternative stability control mode is selected that requires the traction control off depending on the drive mode selected.

Traction Control

TRACTION CONTROL – TROUBLESHOOTING

TRACTION CONTROL – INFORMATION MESSAGES

Message	Action
Service AdvanceTrac	The system detects a condition that requires service. Contact an authorized dealer as soon as possible.
AdvanceTrac Off	The status of the AdvanceTrac system after you switched it off.
AdvanceTrac On	The status of the AdvanceTrac system after you switched it on.
Traction Control Off	The status of the traction control system after you switched it off.
Traction Control On	The status of the traction control system after you switched it on.

Stability Control

HOW DOES STABILITY CONTROL WORK



WARNING: Vehicle modifications involving braking system, aftermarket roof racks, suspension, steering system, tire construction and wheel and tire size may change the handling characteristics of your vehicle and may adversely affect the performance of the electronic stability control system. In addition, installing any stereo speakers may interfere with and adversely affect the electronic stability control system. Reducing the effectiveness of the electronic stability control system could lead to an increased risk of loss of vehicle control, vehicle rollover, personal injury and death.



WARNING: Remember that even advanced technology cannot defy the laws of physics. It's always possible to lose control of a vehicle due to inappropriate driver input for the conditions. Aggressive driving on any road condition can cause you to lose control of your vehicle increasing the risk of personal injury or property damage. Activation of the electronic stability control system is an indication that at least some of the tires have exceeded their ability to grip the road; this could reduce the operator's ability to control the vehicle potentially resulting in a loss of vehicle control, vehicle rollover, personal injury and death.



WARNING: You are responsible for controlling your vehicle at all times. The system is designed to be an aid and does not relieve you of your responsibility to drive with due care and attention. Failure to follow this instruction could result in the loss of control of your vehicle, personal injury or death.

If a driving condition activates either the stability control or traction control you may experience the following conditions:

- The stability and traction control light flashes.
- Your vehicle slows down.
- Reduced engine power.

The stability control system has several features built into it to help you maintain control of your vehicle:

Electronic Stability Control

Electronic stability control enhances your vehicle's ability to prevent skids or lateral slides by applying brakes to one or more of the wheels individually and, if necessary, reducing engine power.

Roll Stability Control

Roll stability control enhances your vehicle's ability to prevent rollovers by detecting your vehicle's roll motion and the rate at which it changes by applying the brakes to one or more wheels individually.

Curve Control

Curve control enhances your vehicle's ability to follow the road when cornering severely or avoiding objects in the roadway. Curve control operates by reducing engine power and, if necessary, applying brakes to one or more of the wheels individually.

Stability Control

Side Wind Stabilization

Side wind stabilization is an advanced feature that works by carefully applying the brakes on one side of the vehicle to reduce the effect of a side wind gust on the vehicle's path.

Traction Control

Traction control enhances your vehicle's ability to maintain traction of the wheels by detecting and controlling wheel spin. See **What Is Traction Control** (page 265).

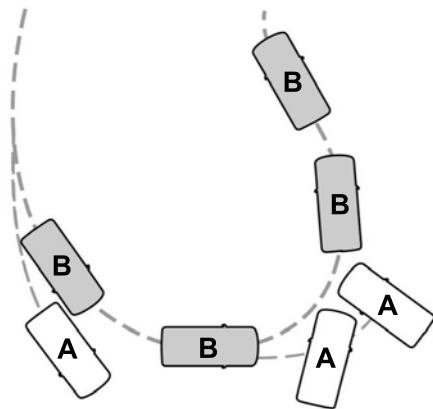

- A Vehicle without stability control skidding off its intended route.
- B Vehicle with stability control maintaining control on a slippery surface.

SWITCHING STABILITY CONTROL ON AND OFF

The system turns on each time you switch the ignition on.

You can switch the electronic stability control system off by pressing and holding the ESC off button for over 5 seconds, or you can press the button again to switch the system on.

Shifting the transmission into reverse (R) will disable the system.

You can switch the traction control system off or on independently. See **Switching Traction Control On and Off** (page 265).

Stability Control

Stability Control and Traction Control with Roll Stability Control

	Stability Control OFF Light	Roll Stability Control	Electronic Stability Control	Traction Control System
Default at start-up	Illuminated during bulb check	Enabled	Enabled ³	Enabled ³
Button pressed momentarily	Illuminated	Enabled	Enabled ³	Disabled ¹
Button pressed and held for 5 - 15 seconds	Illuminated	Enabled	Disabled ²	Disabled ¹
Transfer case is switched to 4x4 Low or put into Rock Crawl Mode	Illuminated	Disabled	Disabled	Disabled ¹

¹ The Traction Control system can still be enabled but with tighter or looser thresholds.

² When you press and hold the button, a progress bar will display to show the button hold time progress.

³ Functions can vary depending on what Selectable Drive Mode the vehicle is currently in.

STABILITY CONTROL INDICATOR



If it does not illuminate when you switch the power on, or remains on, this indicates a malfunction.

Have your vehicle checked by an authorized dealer as soon as possible.

Trail Control (If Equipped)

WHAT IS TRAIL CONTROL



WARNING: The system does not control speed in low traction conditions or extremely steep slopes. The system is designed to be an aid and does not relieve you of your responsibility to drive with due care and attention. Failure to follow this instruction could result in personal injury.



WARNING: The system does not replace the parking brake. When you leave your vehicle, always apply the parking brake.

Trail control lets you focus on steering during low-speed and off-road use by controlling your vehicle's acceleration and braking to maintain the speed that you set.

You may hear a noise from the anti-lock brake system pump motor when you use the system. This is normal.

TRAIL CONTROL LIMITATIONS

Trail control is unavailable when any of the following occur:

- Your vehicle speed is greater than 32 km/h (20 mph) in two-wheel drive high (2H) or four-wheel drive high (4H) modes.
- Your vehicle speed is greater than 15 km/h (9 mph) in four-wheel drive low (4L) mode.
- Your vehicle speed is greater than 8 km/h (5 mph) in reverse (R).
- The transmission is in park (P).
- The driver side door is open or your seatbelt is off when the driver side door is removed.
- Cruise control is on.

- Pro trailer backup assist is on.
- The parking brake is applied.

SWITCHING TRAIL CONTROL ON AND OFF



Press the button.

The system switches off if you press the button again or exceed 68 km/h (42 mph).

SETTING THE TRAIL CONTROL SPEED

Note: *The buttons are located on the steering wheel.*

Drive to your preferred speed.



Press button to increase the set current speed.



Press button to decrease the set current speed.

Note: *The indicator changes color.*

You can adjust the set speed in small or large increments. Press the toggle button upward or downward once to adjust the set speed in small increments. Press and hold the toggle button upward or downward to adjust the set speed in large increments.

You can also decrease the set speed by braking.

Note: *If a set speed is set and the trail control is active and the vehicle is stopped by the brake, releasing the brake will allow the vehicle to accelerate to the set speed. Pressing the brake pedal does not switch off the system.*

Trail Control (If Equipped)

CANCELING THE SET SPEED



Press the button.

TRAIL CONTROL INDICATORS



When trail control is active, the indicator illuminates green in the instrument cluster. When the system is switched on but is unavailable or in standby mode, it illuminates gray.

Trail Control (If Equipped)

TRAIL CONTROL – TROUBLESHOOTING

TRAIL CONTROL – INFORMATION MESSAGES

Message	Details
Reduce Speed To Enter Trail Control	Displays when you must reduce your vehicle speed to use trail control.
Trail Control Not Available with Park Brake Applied	Displays when you must release the park brake to use trail control.
Trail Control Not Available While Pro Trailer Backup Assist™ Active	Displays when you must switch off the trailer backup assist to use trail control.
Trail Control Enabled Use SET Button to Set Speed	Displays when you successfully enabled trail control and can set a speed with the Set+ or Set- control.
Trail Control Off Driver Resume Control	Displays when a system fault has occurred when trail control was active and the driver must resume control.
Trail Control Off	Displays when the system has turned off.
Trail Control Fault See Manual	Displays when a system fault is present. See the trail control section in your Owner's Manual. See your authorized dealer for diagnosis.
Trail Control To Activate Select Gear	Displays when you must be in drive (D), neutral (N) or reverse (R) to use trail control.
Trail Control Not Available with Cruise Control Active	Displays when you must switch the cruise control off to use trail control.
Trail Control Not Available with Driver Door Open	Displays when you must close the driver door to use trail control.
Descent Control Now Active Press Trail Control Switch To Exit	Due to some driver action, Trail Control propulsion was turned off but the vehicle will still brake if descending a hill. The driver must press the Trail Control switch to turn the feature OFF, they can then turn it back on.
Trail Control Not Available with Seatbelt Off	Displays when you must have the seatbelt on to use trail control.

Trail Turn Assist (If Equipped)

WHAT IS TRAIL TURN ASSIST

Trail turn assist can reduce the turning radius of your vehicle by applying the brakes to the inside rear wheel in low-speed, high steering-angle maneuvers.

TRAIL TURN ASSIST PRECAUTIONS

Note: Do not use trail turn assist on dry, hard surfaced roads. Doing so can produce excessive noise, increase tire wear and may damage drive line, or braking components. Trail turn assist is only intended for slippery, or loose surfaces.

You may hear noise from the anti-lock brake system while trail turn assist is active. This is normal operation.

TRAIL TURN ASSIST LIMITATIONS

Trail turn assist can only be used when the vehicle's four-wheel drive system is in the four-wheel drive high (4H), or four-wheel drive low (4L) modes.

Trail Turn Assist cannot be used when the vehicle's rear differential is locked. If the rear differential has recently been locked prior to Trail Turn Assist being turned on, Trail Turn Assist may not activate until it can confirm that the rear differential is unlocked.

SWITCHING TRAIL TURN ASSIST ON AND OFF



While your vehicle is in four-wheel drive high (4H) or four-wheel drive low (4L), press the trail turn assist button on the center console to switch the feature on.

Trail turn assist is on at this time but does not activate until the:

- Vehicle speed is less than 19.3 km/h (12 mph).
- Rear differential is fully unlocked.
- Steering wheel is almost fully turned to the left or right.

Switch trail turn assist off by performing any of the following:

- Press the trail turn assist button again.
- Select two-wheel drive high (2H), or four-wheel drive auto (4A).
- Switch on the rear locking differential.

TRAIL TURN ASSIST INDICATORS



When trail turn assist is on, one of these two indicators will be displayed, depending on the direction of the vehicle's last turn. When the feature is available but not in use, the indicator will be gray. When the feature is active the indicator will be green.

Trail Turn Assist (If Equipped)

TRAIL TURN ASSIST – TROUBLESHOOTING

TRAIL TURN ASSIST – INFORMATION MESSAGES

Message	Details
Trail Turn Assist Available in 4L or 4H	Switch to four-wheel drive low (4L) or four-wheel drive high (4H) to activate trail turn assist. See Selecting a Four-Wheel Drive Mode (page 235).
Trail Turn Assist Not Available See Manual	Trail turn assist system malfunction could be present. If this condition persists, have your vehicle serviced.
Trail Turn Assist ON	You have activated trail turn assist.
Trail Turn Assist OFF	You have switched trail turn assist off.

TRAIL TURN ASSIST – FREQUENTLY ASKED QUESTIONS

Why does Trail Turn Assist not activate after unlocking the rear differential?

The rear differential may not be fully disengaged. When possible, turn off the rear axle locker while driving straight before using trail turn assist. If you are already in a tight turn when you encounter this situation, driving the vehicle for a short distance in reverse could allow the differential to fully disengage.

Hill Descent Control (If Equipped)

WHAT IS HILL DESCENT CONTROL

Hill descent control allows the driver to set and maintain vehicle speed while descending steep slopes in various surface conditions.

HOW DOES HILL DESCENT CONTROL WORK

Hill descent control can maintain vehicle speeds on downhill slopes between 3–32 km/h (2–20 mph). Above 32 km/h (20 mph), the system remains on but the descent speed cannot be set or maintained.

Note: *The system does not function below 3 km/h (2 mph).*

The system requires a cool down interval after a period of sustained use. Hill descent control provides a warning in the message center when the system is about to disengage for cooling. At this time, manually apply the brakes as needed to maintain descent speed.

Note: *The amount of time that the system can remain active before cooling varies with conditions.*

HILL DESCENT CONTROL PRECAUTIONS



WARNING: The system does not control speed in low traction conditions or extremely steep slopes. The system is designed to be an aid and does not relieve you of your responsibility to drive with due care and attention. Failure to follow this instruction could result in personal injury.



WARNING: The system does not replace the parking brake. When you leave your vehicle, always apply the parking brake.

SWITCHING HILL DESCENT CONTROL ON AND OFF



Press the button on the instrument panel. A light illuminates and a tone sounds when the system is active.

SETTING THE HILL DESCENT SPEED

To increase or decrease the descent speed, press the accelerator or brake pedal, or use the SET + and SET - buttons on the steering wheel. Once you reach the preferred speed remove your feet from the pedals.

HILL DESCENT CONTROL INDICATOR



Illuminates when you switch hill descent control on.

Hill Descent Control (If Equipped)

HILL DESCENT CONTROL – TROUBLESHOOTING

HILL DESCENT CONTROL – INFORMATION MESSAGES

Message	Action
For Hill Descent Reduce Speed XX MPH/km/h or Less	Your vehicle speed requirement for off-road mode entry has not been met.
For Hill Descent Select Gear	You need to select a transmission gear for hill descent mode.
Hill Descent Driver Resume Control	Hill descent control mode is deactivated and you must resume control.
Hill Descent Control Fault	A hill descent system fault is present.
Hill Descent Control Off System Cooling	The hill descent system is cooling due to overuse.
Hill Descent Control not available with Cruise Control Active	The hill descent system cannot activate while Cruise Control is actively controlling speed.

HILL DESCENT CONTROL VIDEOS

[Hill Descent Control](#)

Steering

HYDRAULIC POWER STEERING

HYDRAULIC POWER STEERING GUIDELINES

To help prevent damage to the power steering system:

- Do not hold the steering wheel at its furthest turning points for more than three to five seconds when the engine is running.
- Avoid continuously steering back and forth with elevated engine RPM as this may overheat the system. If trying to free a stuck vehicle, pause between attempts to allow the power steering system to cool or seek assistance. Typical steering and driving maneuvers allow the system to cool.
- Do not operate your vehicle if the power steering pump fluid level is below the MIN mark on the reservoir.
- Some noise is normal during operation. If excessive, check for low power steering pump fluid level before seeking service by your dealer.
- Heavy or uneven steering efforts may be caused by low power steering fluid. Check for low power steering pump fluid level before seeking service by your dealer.
- Do not fill the power steering pump reservoir above the MAX mark on the reservoir, as this may result in leaks from the reservoir.

If the power steering system breaks down or if you switch the engine off, you can steer the vehicle manually, but it takes more effort.

If you have any steering components serviced or replaced, install new fasteners. Many fasteners have coatings with thread adhesive, or have prevailing torque features you cannot reuse. Do not reuse a bolt or nut. Torque fasteners to specifications.

Steering Tips

If the steering wanders or pulls, check for:

- An improperly inflated tire.
- Uneven tire wear.
- Loose or worn suspension components.
- Loose or worn steering components.
- Improper vehicle alignment.

Note: *A high crown in the road or high crosswinds may also make the steering seem to wander or pull.*

Electronic Torque Overlay Steering

(If Equipped)



WARNING: The electric power steering system has diagnostic checks that continuously monitor the system. If a fault is detected, a message displays in the information display. Stop your vehicle as soon as it is safe to do so. Switch the ignition off. After at least 10 seconds, switch the ignition on and watch the information display for a steering system warning message. If a steering system warning message returns, have the system checked as soon as possible.



WARNING: If the system detects an error, you may not feel a difference in the steering, however a serious condition may exist. Have your vehicle checked as soon as possible. Failure to do so may result in loss of steering control.

Steering

The electronic torque overlay steering system adds supplemental steering assist to the hydraulic gear when needed, dependent on vehicle conditions such as vehicle speed, steering wheel angle, and steering wheel torque. The hydraulic steering system provides the majority of steering assistance. The electronic torque overlay enables features such as pro trailer backup assistance and lane departure warning.

If your vehicle loses electrical power while you are driving, your vehicle loses electric power steering assistance. The steering system still operates, and you can steer your vehicle with hydraulic assist. Steering your vehicle with only hydraulic assist requires more effort.

Extreme continuous steering may increase the effort required for you to steer your vehicle. This increased effort prevents overheating and permanent damage to the steering system. You do not lose the ability to steer your vehicle manually. Typical steering and driving maneuvers allow the system to cool and return to normal operation.

Adaptive Learning

The electronic power steering system adaptive learning helps correct road irregularities and improves overall handling and steering feel. It communicates with the brake system to help operate advanced stability control and accident avoidance systems. Whenever the battery is disconnected or a new battery installed, you must drive your vehicle a short distance before the system relearns the strategy and reactivates all systems.

Capacities

Variant	Quantity
All.	Fill as required.

LOCATING THE HYDRAULIC POWER STEERING FLUID RESERVOIR

The hydraulic power steering fluid reservoir is found in the engine compartment. See **Under Hood Overview** (page 446).

CHECKING THE HYDRAULIC POWER STEERING FLUID

Check the power steering fluid. See **Scheduled Maintenance** (page 586). If adding fluid is necessary, use MOTORCRAFT HT PSF.

Check the fluid level when it is at ambient temperature.

1. Check the fluid level in the reservoir. It should be between the MIN and MAX range. Do not add fluid if the level is within this range.
2. If the fluid level is low, add fluid to bring the fluid level up to between the MIN and MAX range.
3. Switch the engine on.
4. While the engine idles, turn the steering wheel left and right several times.
5. Switch the engine off.
6. Recheck the fluid level in the reservoir. Do not add fluid if the level is between the MIN and MAX range.
7. If the fluid is low, add fluid in small amounts, continuously checking the level until it is between the MIN and MAX range. Be sure to put the cap back on the reservoir.

Steering

Materials

Name	Specification
Motorcraft® High Temperature Power Steering Fluid(U.S.) Motorcraft® High Temperature Power Steering Fluid / Huile de direction assistée haute température Motorcraft®(Canada) XL-22(U.S. & Canada)	WSS-M2C184-A1

Note: *MERCON LV ATF is also compatible with MOTORCRAFT HT PSF. We recommend you use MOTORCRAFT HT PSF to fill or top off hydraulic power steering systems for model years between 2012 and 2023 that are originally equipped with MERCON LV ATF.*

STEERING – TROUBLESHOOTING

STEERING – INFORMATION MESSAGES

Message	Action
Steering Fault Service Now	The power steering system has detected a condition that requires service. Have your vehicle checked as soon as possible.
Steering Loss Stop Safely	The power steering system is not working. Stop your vehicle in a safe place. Have your vehicle checked as soon as possible.
Steering Assist Fault Service Required	The power steering system has detected a condition that requires service. Have your vehicle checked as soon as possible.
Steering Lock Malfunction Service Now	The steering system has detected a condition that could prevent you from starting your vehicle. Have your vehicle checked as soon as possible.

Parking Aids (If Equipped)

PARKING AID PRECAUTIONS



WARNING: To help avoid personal injury, always use caution when in reverse (R) and when using the sensing system.



WARNING: The system may not detect objects with surfaces that absorb reflection. Always drive with due care and attention. Failure to take care may result in a crash.



WARNING: Traffic control systems, fluorescent lamps, inclement weather, air brakes, external motors and fans may affect the correct operation of the sensing system. This may cause reduced performance or false alerts.



WARNING: The system may not detect small or moving objects, particularly those close to the ground.



WARNING: The parking aid system can only assist you to detect objects when your vehicle is moving at parking speeds. To help avoid personal injury you must take care when using the parking aid system.



WARNING: The system may not function if the sensor is blocked.



WARNING: In cold and severe weather conditions the system may not function. Rain, snow and spray can all limit sensor performance.



WARNING: If damage occurs in the immediate area surrounding the sensor, have your vehicle checked as soon as possible.

Note: If your vehicle sustains damage leaving the sensors misaligned, this will cause inaccurate measurements or false alerts.

When you connect a trailer to your vehicle, the rear parking aid detects the trailer and provides an alert. Disable the parking aid when you connect a trailer to prevent the alert.

Note: Connected trailers might be detected by the vehicle and parking aid turns off automatically in those instances.

Note: Certain add-on devices installed around the bumper or fascia may create false alerts. For example, large trailer hitches, bike or surfboard racks, license plate brackets, bumper covers or any other device could block the normal detection zone of the parking aid system. Aftermarket spare tires or spare tire covers mounted to the rear tailgate could cause false alerts from the park aid system. Remove the add-on device to prevent false alerts.

Note: Keep the sensors free from snow, ice and large accumulations of dirt. If the sensors are covered, the system's accuracy can be affected.

Do not clean the sensors with sharp objects.

SWITCHING PARKING AID ON AND OFF - VEHICLES WITH: FRONT PARKING AID

Muting the Audible Tone



Press the parking aid button to switch the system's audible tone on and off.

Switching Parking Aid On and Off Long-Term

The system can be set to stay disabled in between ignition cycles.

Parking Aids (If Equipped)

1. From the driver assistance menu, press Park Aid sensors. See **Driver Assistance Menu** (page 560).
2. Switch Front Sensors (Always) or Rear Sensors (Always) on or off.

SWITCHING PARKING AID ON AND OFF - VEHICLES WITH: REAR PARKING AID

Muting the Audible Tone



Shift into reverse (R) and press the button on the rear view camera display screen to switch the system's audible tone on and off.

Switching Parking Aid On and Off Long-Term

The system can be set to stay disabled in between ignition cycles.

1. From the driver assistance menu, press Park Aid sensors. See **Driver Assistance Menu** (page 560).
2. Switch Front Sensors (Always) or Rear Sensors (Always) on or off.

REAR PARKING AID

WHAT IS THE REAR PARKING AID

Rear parking sensors detect objects behind your vehicle when in reverse (R).

REAR PARKING AID LIMITATIONS

There is a decreased coverage area at the outer corners.

The rear parking aid sensors are active when your vehicle is in reverse (R) and the vehicle speed is less than 8 km/h (5 mph).

The sensor coverage area is up to 180 cm (71 in) from the rear bumper.

The rear parking aid detects large objects when you shift into reverse (R) and any of the following occur:

- Your vehicle is moving backward at a low speed.
- Your vehicle is stationary but an object is approaching the rear of your vehicle at a low speed.
- Your vehicle is moving backward at a low speed and an object is moving towards your vehicle, for example another vehicle at a low speed.

The system shall provide no audible warning for the object behind the vehicle when in neutral (N) gear.

LOCATING THE REAR PARKING AID SENSORS



Parking Aids (If Equipped)



The rear parking aid sensors are in the rear bumper and in the power tailgate.

Note: *Rear parking sensors in the bumper function when the tailgate is up, and the sensors in the power tailgate function when the power tailgate is down.*

Note: *Reverse braking assist is unavailable when the tailgate is down.*

REAR PARKING AID AUDIBLE WARNINGS

A warning tone sounds when your vehicle approaches an object. As your vehicle moves closer to an object, the rate of the tone increases. The warning tone continuously sounds when an object is 30 cm (12 in) or less from the rear bumper.

If your vehicle remains stationary for a few seconds, the audible warning turns off. If your vehicle moves backward the tone sounds again.

Note: *When the parking aid system sounds a tone, the audio system may reduce the set volume.*

FRONT PARKING AID

WHAT IS THE FRONT PARKING AID

Front parking sensors detect objects in front of your vehicle.

FRONT PARKING AID LIMITATIONS

The front parking aid sensors are active when your vehicle is in any position other than park (P) and the vehicle speed is less than 8 km/h (5 mph).

The sensor coverage area is up to 120 cm (47 in) from the bumper.

If your vehicle is in reverse (R), the front parking aid detects objects when your vehicle is moving at a low speed or an object is moving toward your vehicle and provides an audible warning, for example another vehicle at a low speed. If your vehicle remains stationary for a few seconds, the audible warning turns off. Visual indication is always active in reverse (R).

If your vehicle is in any forward gear, the front parking aid provides audible warnings and visual indication when your vehicle is moving at a speed of 8 km/h (5 mph) or below and the system detects an object within the detection zone. If your vehicle remains stationary for a few seconds, the visual indication and audible warning turns off. If the object is detected within the red zone, the visual indicators remain active.

If your vehicle is in neutral (N), the front and rear sensors provide visual indication only when your vehicle is moving below a speed of 8 km/h (5 mph) and obstacles are detected inside the detection areas. Once your vehicle stops, the visual indication and audible warning stops after a few seconds.

Parking Aids (If Equipped)

LOCATING THE FRONT PARKING AID SENSORS



The front parking aid sensors are in the front bumper.

FRONT PARKING AID AUDIBLE WARNINGS

A warning tone sounds when there is an object within 120 cm (47 in) from the front bumper. As your vehicle moves closer to an object, the rate of the tone increases.

The warning tone continuously sounds when an object is 30 cm (12 in) or less from the front bumper. If your vehicle remains stationary for a few seconds, the audible warning turns off.

Note: *If the detected object is 30 cm (12 in) or less from your vehicle, visual indication remains on.*

PARKING AID INDICATORS

Parking Aid Indicators Shown When 360 Degree Camera Views are not Available



The system provides object distance indication through the touchscreen.

- As the distance to an object decreases, the indicators change color. The indicators for closer objects appear closer to the vehicle icon.
- The indicators are green when the object is at the farthest detection point. As the object gets closer, the indicators turn amber. When the object is at the closest detection point, the indicators turn red.
- If there is no object detected, the distance indicators are not activated.

The activated visual indicators continue displaying when your vehicle is stopped in reverse (R). If stopped in drive (D) or neutral (N), the activated visual indicators disappear after four seconds.

Note: *If stopped in drive (D) or neutral (N) with rear camera delay mode showing the rear camera view, the activated visual indicators continue displaying.*

Parking aids are not available in the following situations:

Parking Aids (If Equipped)

- The system is switched off in the settings menu.
- A trailer is detected. Rear parking aid disables, but front parking aid may continue to operate.
- Sensors are blocked. Front parking aid disables if any front parking sensor is blocked. Rear parking aid disables if any rear parking sensor is blocked.
- A system fault occurs.

Note: *If the parking aids are not available, the distance indicators do not display. See **Parking Aids – Troubleshooting** (page 284).*

Note: *Front park aid indicators may not be available.*

Parking Aid Indicators Shown in 360 Degree Camera Views (If Equipped)



The system provides object distance indication through the touchscreen.

- As the distance to an object decreases, the indicators change color.
- The indicators are green when the object is at the farthest detection point. As the object gets closer, the indicators turn amber. When the object is at the closest detection point, the indicators turn red.
- If there is no object detected, the distance indicators are not activated.

The activated visual indicators continue displaying when your vehicle is stopped in reverse (R). If stopped in drive (D) or neutral (N), the activated visual indicators disappear after four seconds.

Note: *If stopped in drive (D) or neutral (N) with rear camera delay mode showing the rear camera view, the activated visual indicators continue displaying.*

Parking aids are not available in the following situations:

- The system is switched off in the settings menu.
- A trailer is detected. Rear parking aid disables, but front parking aid may continue to operate.
- Sensors are blocked. The distance indicators appear white. Front parking aid disables if any front parking sensor is blocked. Rear parking aid disables if any rear parking sensor is blocked.
- A system fault occurs.

Note: *If the parking aids are not available, the distance indicators do not display. See **Parking Aids – Troubleshooting** (page 284).*

PARKING AIDS – TROUBLESHOOTING

PARKING AIDS – INFORMATION MESSAGES

If a fault is present in the parking aids, a warning message appears in the instrument cluster or the touchscreen.

Parking Aids (If Equipped)

Message	Action
Park Aid Fault	The system detects a condition that requires service. Have your vehicle checked as soon as possible. You may be able to resolve by cleaning the sensors and restarting your vehicle.
Parking Sensors Blocked	Inclement weather, ice, mud, or water is blocking the sensor, causing the system to become unavailable. You can typically clean the sensor to resolve.
Trailer Connected	An electrical trailer connection is sensed during a given ignition cycle.

PARKING AIDS VIDEOS

[Reverse Sensing System Video Link](#)

Rear View Camera (If Equipped)

WHAT IS THE REAR VIEW CAMERA

The rear view camera provides a video image of the area behind your vehicle when the transmission is in reverse (R).



The rear view camera button is on the instrument panel.

REAR VIEW CAMERA PRECAUTIONS



WARNING: The rear view camera system is a reverse aid supplement device that still requires the driver to use it in conjunction with the interior and exterior mirrors for maximum coverage.



WARNING: Objects that are close to either corner of the bumper or under the bumper, might not be seen on the screen due to the limited coverage of the camera system.



WARNING: Objects above the camera may not be visible. Check the area behind your vehicle when necessary.



WARNING: Reverse your vehicle slowly. Failure to follow this instruction could result in the loss of control of your vehicle, personal injury or death.



WARNING: Use caution when the liftgate or tailgate is ajar. If the liftgate or tailgate is ajar, the camera will be out of position and the video image could be incorrect. All guide lines disappear when the liftgate or tailgate is ajar. Failure to follow this instruction could result in personal injury.



WARNING: Do not switch the camera features on or off when your vehicle is moving.

Note: *When towing, the camera only sees what you are towing. This might not provide adequate coverage and you might not see some objects. In some vehicles, the guidelines may disappear when you connect the trailer tow connector.*

LOCATING THE REAR VIEW CAMERA

The rear view camera is on the tailgate. It provides a video image of the area behind your vehicle.

Rear View Camera (If Equipped)

REAR VIEW CAMERA GUIDE LINES

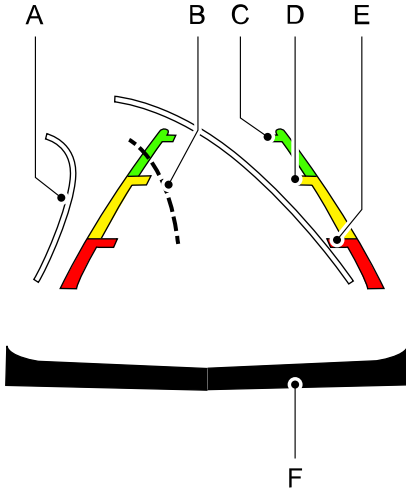

- A Active guide lines.
- B Centerline.
- C Fixed guide line: Green zone.
- D Fixed guide line: Yellow zone.
- E Fixed guide line: Red zone.
- F Rear bumper.

Active guide lines only show with fixed guide lines. To use active guide lines, turn the steering wheel to point the guide lines toward an intended path. If the steering wheel position changes while reversing, your vehicle might deviate from the intended path.

The fixed and active guide lines fade in and out depending on the steering wheel position. The active guide lines do not display when the steering wheel position is straight.

Use caution while reversing. Objects in the red zone are closest to your vehicle and objects in the green zone are farther away. Objects get closer to your vehicle as they move from the green zone to the yellow or red zones. Use the side view mirrors and rear view mirror to get better coverage on both sides and rear of your vehicle.

Note: Active guide lines and fixed guide lines are only available when the transmission is in reverse (R).

Note: The centerline is only available if the active or fixed guide lines are on.

Note: Not all camera modes work properly without an auxiliary camera.

REAR VIEW CAMERA SETTINGS

ZOOMING THE REAR VIEW CAMERA IN AND OUT

 **WARNING:** When manual zoom is on, the full area behind your vehicle may not show. Be aware of your surroundings when using the manual zoom feature.

Selectable settings for this feature are zoom in (+) and zoom out (-). Press the symbol on the camera screen to change the view. The default setting is zoom off.

This allows you to get a closer view of an object behind your vehicle. The zoomed image keeps the bumper in the image to provide a reference. The zoom is only active while the transmission is in reverse (R).

Rear View Camera (If Equipped)

Note: *Zooming in also engages park hold which applies the electric park brake when you shift to park (P). When you press the zoom button, the electronic park hold button illuminates on the touchscreen. See **Connecting a Trailer** (page 359).*

Note: *Manual zoom is only available when the transmission is in reverse (R).*

Note: *Only the centerline shows when you enable manual zoom.*

SWITCHING REAR VIEW CAMERA DELAY ON AND OFF

1. From the driver assistance menu, press Rear View Camera. See **Driver Assistance Menu** (page 560).
2. Switch rear view camera delay on or off.

When shifting the transmission out of reverse (R) and into any gear other than park (P), the camera image remains in the display until:

- Your vehicle speed reaches approximately 8 km/h (5 mph).
- You shift your vehicle into park (P).

360 Degree Camera (If Equipped)

WHAT IS THE 360 DEGREE CAMERA

The 360 degree camera system consists of front, side and rear cameras which provide visibility around your vehicle.

HOW DOES THE 360 DEGREE CAMERA WORK

The 360 degree camera system consists of front, side and rear cameras.

The 360 Degree Camera system:

- Allows you to see what is directly in front of or behind your vehicle.
- Provides a cross traffic view in front of and behind your vehicle.
- Allows you to see a top-down view of the area outside your vehicle, including the blind spots and obstacles near your vehicle.

360 DEGREE CAMERA PRECAUTIONS



WARNING: The 360 degree camera system still requires the driver to use it in conjunction with looking out of the windows, and checking the interior and exterior mirrors for maximum coverage.



WARNING: Objects that are close to either corner of the bumper or under the bumper, might not be seen on the screen due to the limited coverage of the camera system.



WARNING: Do not switch the camera features on or off when your vehicle is moving.



WARNING: You are responsible for controlling your vehicle at all times. The system is designed to be an aid and does not relieve you of your responsibility to drive with due care and attention. Failure to follow this instruction could result in the loss of control of your vehicle, personal injury or death.



WARNING: Use caution when the tailgate is ajar. If the tailgate is ajar, the camera is out of position and the video image could be incorrect. All guide lines disappear when the tailgate is ajar. Failure to follow this instruction could result in personal injury.



WARNING: When manual zoom is on, the full area behind your vehicle may not show. Be aware of your surroundings when using the manual zoom feature.

LOCATING THE 360 DEGREE CAMERAS

Rear View Camera

The rear view camera is on the tailgate. It provides a video image of the area behind your vehicle.

Rear View Camera with Tailgate Lowered

This camera is on top of the tailgate and allows you to see the area behind your vehicle with the tailgate lowered. This view is available in the rear normal view and the 360 degree camera view. The vehicle icon in the 360 camera view on screen reflects that the tailgate is down. With the tailgate in the lowered position, you do not have a view of the hitch, split view, or zoom view.

360 Degree Camera (If Equipped)

Note: This feature is intended for special scenarios only and not for general driving conditions.

Note: These views are not identical to when the tailgate is up. The guidelines are not available.

Front View Camera

The front view camera is in the grille. It provides a video image of the area in front of your vehicle.

Side View Camera

The side view camera is on the outside mirror. It provides a video image of the area on the sides of your vehicle to aid you when parking or when backing up a trailer.

Bed Camera

The bed camera is mounted within the high-mount stop lamp. It displays the contents of your truck bed. The camera contains a dynamic guideline to help locate the center of your vehicle. This view can be accessed while in drive (D) or reverse (R).

Auxiliary Camera

The auxiliary camera is a variant of the rear view camera and you can access it by pressing the AUX button on the display screen when moving in reverse (R) or in drive (D). It displays a rear view image from the back of a trailer while in reverse.

360 DEGREE CAMERA GUIDE LINES

Note: Active guide lines are only available when the transmission is in reverse (R).

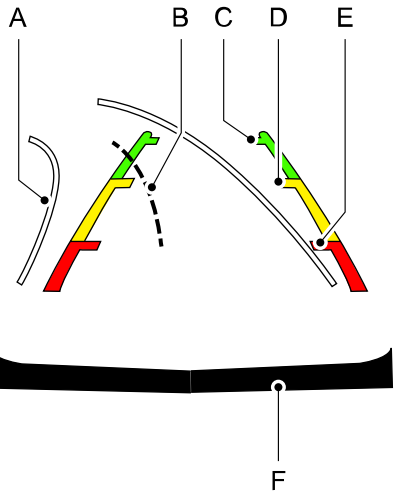

- A Active guide lines.
- B Centerline.
- C Fixed guide line: Green zone.
- D Fixed guide line: Yellow zone.
- E Fixed guide line: Red zone.
- F Rear bumper.

Active guide lines only show with fixed guide lines. Turn the steering wheel to point the guide lines toward an intended path. If the steering wheel position changes when reversing, your vehicle could deviate from the intended path.

The fixed and active guide lines fade in and out depending on the steering wheel position. The active guide lines do not display when the steering wheel position is straight.

360 Degree Camera (If Equipped)

Objects in the red zone are closest to your vehicle and objects in the green zone are farther away. Objects get closer to your vehicle as they move from the green zone to the yellow or red zones. Use the side view mirrors and rear view mirror to get better coverage on both sides and rear of your vehicle.

Keep Out Zone

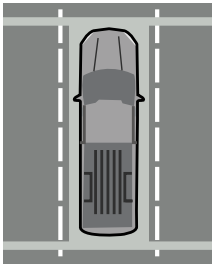

The keep out zone is represented by the yellow dotted lines running parallel to your vehicle.

360 DEGREE CAMERA SETTINGS

SWITCHING THE 360 DEGREE CAMERA ON AND OFF



The 360 degree camera system button is on the instrument panel. The front and rear cameras have multiple screens which consist of:

- Normal view.
- Normal view with 360.
- Split view.
- Bed camera.

- Auxiliary camera.
- Hitch view.

Note: *The rear view camera activates when you switch into reverse (R). Additional views are then accessible on the touchscreen.*

When in park (P), neutral (N) or drive (D), the front images display when the button is pressed. When in reverse (R), only the rear images display when the button is pressed.

Note: *Not all cameras are available.*

Note: *The 360 degree camera system turns off when your vehicle is in motion at low speed, except when in reverse (R).*

SWITCHING THE 360 DEGREE CAMERA VIEW



Press to access the different camera views.



Front normal view provides an image of what is directly in front of your vehicle.



Front split view provides an extended view of what is in front of your vehicle.



Normal + 360 degree view contains the normal camera view next to a 360 degree camera view.



Rear normal view provides an image of what is directly behind your vehicle.



Rear split view provides an extended view of what is behind your vehicle.



Bed camera shows the truck bed.

360 Degree Camera (If Equipped)



Trailer AUX camera shows a rear view camera image of what is behind your trailer. This camera is purchased and installed separately.



The hitch view provides an image of the area around the tow hitch.



Trailer reverse guidance shows the sides of your truck and trailer. See **Trailer Reverse Guidance** (page 403).



Zooms in on the image and park hold is activated. See **Connecting a Trailer** (page 359).



Zooms in on the 360 degree image.

Note: *The rear normal view, bed camera view, hitch view and trailer auxiliary view are available when your vehicle speed is greater than 10 km/h (6 mph).*

Cruise Control

WHAT IS CRUISE CONTROL

Cruise control lets you maintain a set speed without keeping your foot on the accelerator pedal.

Requirements

Use cruise control when the vehicle speed is greater than 20 km/h in metric units or 15 mph in imperial units.

SWITCHING CRUISE CONTROL ON AND OFF



WARNING: Do not use cruise control on winding roads, in heavy traffic or when the road surface is slippery. This could result in loss of vehicle control, serious injury or death.

The cruise controls are on the steering wheel.

Switching Cruise Control On



Press the button to activate the system. When the system activates, the set speed is equal to the current vehicle speed or 20 km/h (15 mph), whichever is greater. If the speed is too low, or other conditions are not correct for cruise control activation, the system enters standby mode.

Switching Cruise Control Off



Press the button when the system is active or switch the ignition off.

Note: When you switch cruise control off, the set speed clears.

SETTING THE CRUISE CONTROL SPEED



WARNING: When you are going downhill, your vehicle speed could increase above the set speed. The system does not apply the brakes.

Drive to the speed you prefer.

SET+

Press either the SET+ or SET- buttons to set the current speed.

SET-

Take your foot off the accelerator pedal.

Note: The indicator changes color in the information display.

Changing the Set Speed

SET+

Press the SET+ button to increase the set speed in small increments. Press and hold the SET+ button to accelerate. Release the button when you have reached your preferred speed.

SET-

Press the SET- button to decrease the set speed in small increments. Press and hold the SET- button to decelerate. Release the button when you have reached your preferred speed.

Note: If you accelerate by pressing the accelerator pedal, the set speed does not change. When you release the accelerator pedal, your vehicle returns to the speed that you previously set.

Cruise Control

CANCELING THE SET SPEED



Press the button, or tap the brake pedal to cancel the set speed.

Note: *The system remembers the set speed.*

Note: *The system cancels if the vehicle speed drops below 16 km/h (10 mph) under the set speed when driving uphill.*

RESUMING THE SET SPEED



Press the button.

CRUISE CONTROL INDICATORS



Illuminates when you switch the system on.

Adaptive Cruise Control (if Equipped)

HOW DOES ADAPTIVE CRUISE CONTROL WITH STOP AND GO WORK

Adaptive cruise control with stop and go uses radar and camera sensors to maintain a set gap between your vehicle and the vehicle in front of you while following it to a complete stop. Stop and go can also be set to follow a vehicle directly in front of you and adjust the set speed, while you are at a complete stop.

ADAPTIVE CRUISE CONTROL PRECAUTIONS



WARNING: You are responsible for controlling your vehicle at all times. The system is designed to be an aid and does not relieve you of your responsibility to drive with due care and attention. Failure to follow this instruction could result in the loss of control of your vehicle, personal injury or death.



WARNING: Do not use adaptive cruise control on winding roads, in heavy traffic or when the road surface is slippery. This could result in loss of vehicle control, serious injury or death.



WARNING: Pay close attention to changing road conditions such as entering or leaving a highway, on roads with intersections or roundabouts, roads without visible lanes of travel, roads that are unpaved, or steep slopes. Failure to follow this instruction could result in the loss of control of your vehicle, personal injury or death.



WARNING: The system is not a crash warning or avoidance system.



WARNING: Do not use the system when towing a trailer that has aftermarket electronic trailer brake controls. Failure to follow this instruction could result in the loss of control of your vehicle, personal injury or death.



WARNING: Do not use tire sizes other than those recommended because this can affect the normal operation of the system. Failure to do so may result in a loss of vehicle control, which could result in serious injury.



WARNING: Do not use the system with a snow plow blade installed.



WARNING: In situations with poor visibility, such as fog, heavy rain or other inclement weather, you may need to override or completely switch off the system.

When Following a Vehicle



WARNING: When following a vehicle that is braking, your vehicle does not always decelerate quickly enough to avoid a crash without driver intervention. Apply the brakes when necessary. Failure to follow this instruction could result in personal injury or death.

Hilly Condition and Trailer Tow Usage

You should select a lower gear when the system is active in situations such as prolonged downhill driving on steep slopes, for example in mountainous areas. The system needs additional engine braking in these situations to reduce the load on the vehicle's regular brake system to prevent it from overheating.

Adaptive Cruise Control (If Equipped)

Note: An audible alarm sounds and the system shuts down if it applies brakes for an extended period of time. This allows the brakes to cool. The system functions normally again after the brakes cool.

Note: When towing with adaptive cruise control, switch on Tow/Haul mode and diesel engine brake.

Note: Tow/Haul mode increases the time gaps and allows more distance for braking.

ADAPTIVE CRUISE CONTROL LIMITATIONS

Sensor Limitations

WARNING: On rare occasions, detection issues can occur due to the road infrastructures, for example bridges, tunnels and safety barriers. In these cases, the system may brake late or unexpectedly. At all times, you are responsible for controlling your vehicle, supervising the system and intervening, if required.

WARNING: If the system malfunctions, have your vehicle checked as soon as possible.

WARNING: Large contrasts in outside lighting can limit sensor performance.

WARNING: The system only warns of vehicles detected by the radar sensor. In some cases there may be no warning or a delayed warning. Apply the brakes when necessary. Failure to follow this instruction could result in personal injury or death.

WARNING: The system may not detect stationary or slow moving vehicles below 10 km/h (6 mph).

WARNING: The system does not detect pedestrians or objects in the road.

WARNING: The system does not detect oncoming vehicles in the same lane.

WARNING: The system may not operate properly if the sensor is blocked. Keep the windshield free from obstruction.

WARNING: The sensor may incorrectly track lane markings as other structures or objects. This can result in a false or missed warning.

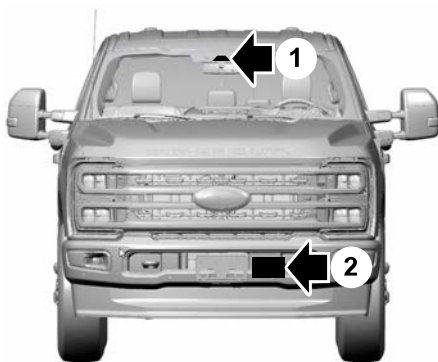

1. Camera.
2. Radar sensor.

The camera is on the windshield behind the interior mirror.

The radar sensor is in the lower grille.

Adaptive Cruise Control (If Equipped)

Note: You cannot see the sensor. It is behind a fascia panel.

Note: Keep the front of your vehicle free of dirt, metal badges or objects. Vehicle front protectors, aftermarket lights, additional paint or plastic coatings could also degrade sensor performance.

A message displays if something obstructs the camera or the sensor. When something blocks the sensor, the system cannot detect a vehicle ahead and does not function. See **Adaptive Cruise Control – Information Messages** (page 308).

The radar sensor has a limited field of view. It may not detect vehicles at all or detect a vehicle later than expected in some situations. The lead vehicle image does not illuminate if the system does not detect a vehicle in front of you.

Detection Issues Can Occur:

A

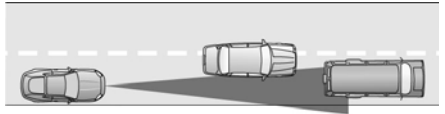

B



C

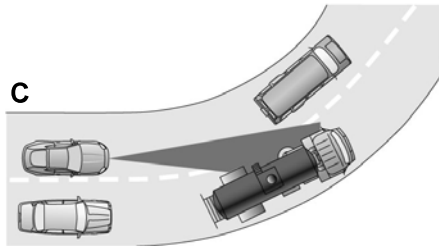

- A When driving on a different line than the vehicle in front.
- B With vehicles that edge into your lane. The system can only detect these vehicles once they move fully into your lane.
- C There may be issues with the detection of vehicles in front when driving into and coming out of a bend or curve in the road.

In these cases, the system may brake late or unexpectedly.

If something hits the front end of your vehicle or damage occurs, the radar-sensing zone may change. This could cause missed or false vehicle detection.

Adaptive Cruise Control (If Equipped)

Optimal system performance requires a clear view of the road by the windshield camera.

Optimal performance may not occur if:

- The camera is blocked.
- There is poor visibility or lighting conditions.
- There are bad weather conditions.

SWITCHING ADAPTIVE CRUISE CONTROL ON AND OFF

The cruise controls are on the steering wheel.

Switching Adaptive Cruise Control On



Press the button to activate the system. When the system activates, the set speed is equal to whichever is greater, the current vehicle speed, or 15 mph when in imperial units or 20 km/h when in metric units. If the speed is too low, or other conditions are not correct for adaptive cruise control activation, the system enters standby mode. When you are below 15 mph when in imperial units or 20 km/h when in metric units, adaptive cruise control does not activate unless you are following another vehicle.

The indicator, current gap setting and set speed appear in the instrument cluster display.

Switching Adaptive Cruise Control Off



Press the button when the system is in standby mode or switch your vehicle off.

Note: When you switch the system off, the set speed clears.

ADAPTIVE CRUISE CONTROL AUTOMATIC CANCELLATION

The system may cancel if:

- The tires lose traction.
- You apply the parking brake.

The system may cancel and set the parking brake if:

- You unbuckle the seatbelt and open the driver door after adaptive cruise control stops your vehicle.
- Adaptive cruise control holds your vehicle at a stop continuously for more than three minutes.

The system may deactivate or prevent activating when requested if:

- The vehicle has a blocked sensor.
- The brake temperature is too high.
- There is a failure in the system or a related system.

SETTING THE ADAPTIVE CRUISE CONTROL SPEED

Drive to the speed you prefer.



Press the SET+ or SET- buttons to set the current speed.



Take your foot off the accelerator pedal.

The indicator, current gap setting and set speed appear in the instrument cluster display.

A vehicle image illuminates if there is a vehicle detected in front of you.

Adaptive Cruise Control (if Equipped)



Note: When adaptive cruise control is active, the speedometer may vary slightly from the set speed displayed in the instrument cluster display.

Setting the Adaptive Cruise Speed from a Complete Stop

SET+

Press the SET+ or SET- buttons while keeping the brake pedal fully depressed.

SET-

The set speed adjusts to 20 km/h when in metric units or 15 mph when in imperial units.

The indicator, current gap setting and set speed appear in the instrument cluster display.

Note: The system activates from a complete stop only when it detects a lead vehicle in close proximity.

Manually Changing the Set Speed

SET+

Press the SET+ button to increase the set speed in small increments. Press and hold the SET+ button to increase set speed in large increments. Release the button when the indicated set speed reaches the preferred speed.

SET-

Press the SET- button to decrease the set speed in small increments. Press and hold the SET- button to decrease the set speed in large increments. Release the button when the indicated set speed reaches the preferred speed.

You can also press the accelerator or brake pedal until you reach the speed you prefer. Press the SET+ or SET- button to select the current speed as the set speed.

The system may apply the brakes to slow the vehicle to the new set speed. The set speed continuously displays in the instrument cluster display when the system is active.

SETTING THE ADAPTIVE CRUISE CONTROL GAP



Press the button to cycle through the four gap settings.



The selected gap appears in the information display as shown by the bars in the image.

Note: The gap setting is time dependent and therefore, the distance adjusts with your vehicle speed.

Note: It is your responsibility to select a gap appropriate to the driving conditions.

Adaptive Cruise Control (If Equipped)

Adaptive Cruise Control Gap Settings

Graphic Display, Bars Indicated Between Vehicles	Gap Distance	Dynamic Behavior
1	Closest.	Sport.
2	Close.	Normal.
3	Medium.	Normal.
4	Far.	Comfort.

Each time you switch the system on, it selects the last chosen gap setting.

Following a Vehicle

When a vehicle ahead of you enters the same lane or a slower vehicle is ahead in the same lane, the vehicle speed adjusts to maintain the gap setting.

Note: *When you are following a vehicle and you switch on a turn signal lamp, adaptive cruise control may provide a small, temporary acceleration to help you pass.*

Your vehicle maintains a consistent gap from the vehicle ahead until:

- The vehicle in front of you accelerates to a speed above the set speed.
- The vehicle in front of you moves out of the lane you are in.
- You set a new gap distance.

The system applies the brakes to slow down your vehicle to maintain a safe gap distance from the vehicle in front of you. The system only applies limited braking. You can override the system by applying the brakes.

Note: *The brakes may emit noise when applied by the system.*

If the system determines that its maximum braking level is not sufficient, an audible warning sounds, a message appears in the information display and an indicator flashes when the system continues to brake. Take immediate action.

CANCELING THE SET SPEED



Press the button or tap the brake pedal.

The set speed does not erase.

RESUMING THE SET SPEED



Press the button.

Your vehicle speed returns to the previously set speed and gap setting. The set speed displays continuously in the information display when the system is active.

Note: *Only use resume if you are aware of the set speed and intend to return to it.*

Resuming the Set Speed from a Complete Stop (If Equipped)

If your vehicle follows a vehicle to a complete stop and remains stationary for less than a few seconds, your vehicle accelerates from a stationary position to follow the vehicle ahead.

If your vehicle follows a vehicle to a complete stop and remains stationary for more than a few seconds, an indicator and message displays.

Adaptive Cruise Control (if Equipped)



Message	Details
Stopped	Cruise control does not resume automatically when this display is active.
Press button to resume	If the lead vehicle begins to move, you are prompted to press the resume button. Press and release the button or use the accelerator pedal to resume following the lead vehicle.
Auto-Resume	Displays when on a limited access highway after following a vehicle to a complete stop. In this situation, the vehicle resumes following the lead vehicle without a button press or pressing the accelerator pedal. The system can remain in auto-resume state for approximately 30 seconds, after which it no longer automatically resumes.

OVERRIDING THE SET SPEED



WARNING: If you override the system by pressing the accelerator pedal, it does not automatically apply the brakes to maintain a gap from any vehicle ahead.

When you press the accelerator pedal, you override the set speed and gap distance.

Use the accelerator pedal to intentionally exceed the set speed limit.

When you override the system, the indicator remains blue, the set speed is dimmed and the lead vehicle icon does not appear in the instrument cluster display.

The system resumes operation when you release the accelerator pedal. The vehicle speed decreases to the set speed, or a lower speed if following a slower vehicle.

Adaptive Cruise Control (If Equipped)

ADAPTIVE CRUISE CONTROL INDICATORS



Illuminates when you switch adaptive cruise control on. The color of the indicator changes to indicate the system status.

White indicates the system is on but inactive.

Blue indicates that you set the speed and the system is active.

SWITCHING FROM ADAPTIVE CRUISE CONTROL TO CRUISE CONTROL



WARNING: Normal cruise control will not brake when your vehicle is approaching slower vehicles. Always be aware of which mode you have selected and apply the brakes when necessary.

1. From the driver assistance menu, press Cruise Control. See **Driver Assistance Menu** (page 560).
2. Press Normal Cruise Control.



When you select normal cruise control the cruise control indicator replaces the adaptive cruise control indicator. The gap setting does not display, and the system does not respond to lead vehicles. Automatic braking remains active to maintain the set speed. The system remembers the last setting when you start your vehicle.

LANE CENTERING

HOW DOES LANE CENTERING WORK

Adaptive cruise control with lane centering uses the vehicle's front radar sensor and front windshield camera sensor, together with the steering sensor to operate.

Using these sensors, the system applies continuous steering assistance towards driving in the middle of the lane.

Note: *The gap setting for adaptive cruise control with lane centering, operates in the same way as normal adaptive cruise control.*

LANE CENTERING PRECAUTIONS



WARNING: Do not use the system when towing a trailer or when the vehicle is loaded to near or over maximum payload. Failure to follow this instruction could result in the loss of control of your vehicle, personal injury or death.



WARNING: Do not use the system if any changes or modifications to the steering, suspension system or wheels and tires have been made. Any changes or modifications to the steering, suspension system or wheels and tires could affect the functionality and performance of the system. Failure to follow this instruction could result in the loss of control of your vehicle, personal injury or death.

Adaptive cruise control precautions apply to lane centering unless stated otherwise or contradicted by a lane centering precaution. See **Adaptive Cruise Control Precautions** (page 295).

Adaptive Cruise Control (If Equipped)

LANE CENTERING REQUIREMENTS

You must keep your hands on the steering wheel at all times.

Lane centering only activates when all of the following occur:

- Adaptive cruise control with lane centering is enabled in the touchscreen. See **Switching Lane Centering On and Off** (page 303).
- You have adaptive cruise control enabled and set.
- The steering system detects your hands on the steering wheel.
- The system detects both lane markings when driving on a straight road.
- Your vehicle is initially centered in the lane between two visible line markings.
- A trailer is not detected.

Note: *If the system does not detect valid lane line markings, the system remains in standby until valid line markings are available.*

Note: *If the system does not detect your hands on the steering wheel, apply a slight force to the steering wheel.*

LANE CENTERING LIMITATIONS

Adaptive cruise control limitations apply to lane centering unless stated otherwise or contradicted by a lane centering limitation. See **Lane Centering Requirements** (page 303).

Lane Centering may not be able to center your vehicle in the lane in any of the following conditions:

- The lane is too narrow or wide.
- The curve in the road is too tight.
- The system does not detect the minimum required lane markings or when lanes merge or split.

- When the required steering effort to maintain lane center exceeds the lane centering system limit.
- When driving in areas that are under construction or when road work is in progress.
- If the front windshield camera and/or the front radar are blocked.
- When using a spare tire.
- Inclement weather conditions including, but not limited to, high wind, heavy rain, and fog.
- Driving into direct sunlight.
- When modification to the steering system has been made, including alterations to the steering wheel.
- When a trailer is detected, the system disables lane centering. See **Lane Centering Precautions** (page 302).

Note: *The system steering assistance is limited and may not have sufficient effort for all driving situations and/or conditions, such as driving through tight curves or driving through curves at high speeds.*

Note: *In exceptional conditions, the system may deviate from the lane center.*

SWITCHING LANE CENTERING ON AND OFF

Keep your hands on the steering wheel at all times.

The controls are on the steering wheel.



Press the button.

The indicator appears in the instrument cluster display. When the system is on, the color of the indicator changes to indicate the system status.

You can override the system at any time by steering your vehicle.

Adaptive Cruise Control (If Equipped)

Note: The correct requirements must be met before you can switch the system on. See **Lane Centering Requirements** (page 303).

Enabling and Disabling Lane Centering

1. From the driver assistance menu, press Cruise Control. See **Driver Assistance Menu** (page 560).
2. Press Adaptive Cruise Control.
3. Press Lane Centering.

LANE CENTERING ALERTS

You must keep your hands on the steering wheel at all times.

When the system is active and detects no steering activity for a period of time, the system alerts you to put your hands on the steering wheel. If you do not react appropriately to the warnings the adaptive cruise control with lane centering system cancels and slows your vehicle down to idle speeds while maintaining steering control. See **Lane Centering Automatic Cancellation** (page 304).

The system also alerts you if your vehicle crosses lane line markings without detected steering activity.

Note: The system could detect a light grip or light touch on the steering wheel as hands-off driving.

LANE CENTERING AUTOMATIC CANCELLATION

When an external condition cancels the system, and your hands are on the steering wheel, a tone sounds and a message appears in the instrument cluster display.

When an external condition cancels the system, and your hands are not on the steering wheel, the system immediately alerts you to take control of the vehicle. If this alert is ignored, the system slows the vehicle while maintaining steering assistance when lane markings are available. When no lane markings are available, the vehicle comes to a stop.



If your vehicle starts to slow down after system cancellation, you must take full control of the vehicle. To re-enable adaptive cruise control with lane centering after cancellation, press and release the resume button.

Automatic cancellation can also occur if:

- The lane becomes too wide or narrow.
- The system cannot detect valid lane markings.
- Lane markings cross over one another.
- The curve of the road is too sharp.

Note: If your vehicle slows down due to your inactivity twice within a key cycle, the system disables. To reset the system, when the vehicle is stationary, return the gear selector to park (P) and turn the vehicle off. Then, restart the vehicle with your foot on the brake pedal.

LANE CENTERING MANUAL CANCELLATION

Adaptive cruise control with lane centering is cancelled when the adaptive cruise control button on the steering wheel is pressed.

Note: If the brake pedal is pressed, lane centering goes into standby until the resume button is pressed.

The lane centering system momentarily pauses when either of the following actions are performed:

Adaptive Cruise Control (If Equipped)

- Turn signal lever is pushed or tapped with added steering input.
- You steer the vehicle out of the lane.

Amber status with an audible tone, that then changes to gray status, indicates a system automatic cancellation.

LANE CENTERING INDICATORS



Illuminates when you switch lane centering on. The color of the indicator changes to indicate the system status.

Gray status indicates the system is on but in standby mode.

Blue status indicates the system is enabled and applying steering assistance to keep the vehicle in the center of the lane.

LANE CENTERING – TROUBLESHOOTING

LANE CENTERING – INFORMATION MESSAGES

Note: *Depending on your vehicle options and instrument cluster type, some messages can appear different or not at all.*

Message	Details
Keep Hands on Steering Wheel	You must return your hands to the steering wheel and provide steering input to cancel the message.
Lane Centering Assist Not Available	Lane centering is currently not available, due to conditions that prevent the system from becoming active. To reset the system, when the vehicle is stationary, return the gear selector to park (P) and turn the vehicle off. Then, restart the vehicle with your foot on the brake pedal.
Resume Control	Adaptive cruise control with lane centering is about to cancel. You must immediately take full control of the vehicle.
Press Accelerator Pedal to Resume	Adaptive cruise control with lane centering is in standby mode. When safe to do so, you can resume adaptive cruise control with lane centering by applying pressure on the accelerator pedal. Alternatively, you can also re-enable adaptive cruise control with lane centering by pressing the resume button on the steering wheel.

Adaptive Cruise Control (If Equipped)

PREDICTIVE SPEED ASSIST (IF EQUIPPED)

HOW DOES PREDICTIVE SPEED ASSIST WORK

Predictive Speed Assist works with adaptive cruise control and adjusts the vehicle speed to the road geometry and to the speed limit detected by the speed sign recognition system. As the system identifies curves and highway exits, the vehicle speed temporarily decreases ahead of and during the changing road geometry. When passing new speed signs, the set speed updates. See **Predictive Speed Assist Precautions** (page 306).

There are limitations that affect the accuracy of the speed sign recognition system and its ability to determine the current speed limit. Predictive speed assist and its ability to determine the current speed limit shares these limitations. See **Speed Sign Recognition** (page 346).

Note: *The adaptive cruise control gap setting operates normally when the feature is enabled.*

PREDICTIVE SPEED ASSIST PRECAUTIONS

 **WARNING:** You are responsible for controlling your vehicle at all times. The system is designed to be an aid and does not relieve you of your responsibility to drive with due care and attention. Failure to follow this instruction could result in the loss of control of your vehicle, personal injury or death.

 **WARNING:** Pay close attention to changing road conditions. You may need to override the system by pressing the brake or accelerator pedal if the adjusted speed becomes higher or lower than necessary.

 **WARNING:** The system only provides limited braking. Your vehicle may not always decelerate quickly enough to avoid a crash without driver intervention. Apply the brakes when necessary.

 **WARNING:** The system does not activate the turn signal.

Adaptive cruise control precautions apply to predictive speed assist unless stated otherwise or contradicted by a predictive speed assist precaution. See **Adaptive Cruise Control Precautions** (page 295).

The system only applies limited braking. You can override the system with the accelerator pedal or cancel the system by applying the brakes.

The system may adapt to various factors such as time of day, lane width. This could influence speed adjustments and accelerations.

The system may adapt to various drive modes. See **Drive Mode Control** (page 310). This could influence speed adjustments and accelerations.

Note: *The system does not activate the turn signal automatically.*

Adaptive Cruise Control (If Equipped)

PREDICTIVE SPEED ASSIST LIMITATIONS



WARNING: The system may not always adjust vehicle speed in certain road or weather conditions such as crossing traffic, yield or stop signs, right of way, traffic lights, speed bumps, rain, snow, fog. You must always apply the brake or accelerator pedal when necessary.

The road geometry and speed limit information provided by the navigation map data could be inaccurate or out of date.

The system may not detect and read speed limit signs with conditional information, for example, when a sign is flashing, during specific time ranges, or when children are present.

Note: *The system does not set the vehicle speed to speed limits shown with a supplementary traffic sign.*

Under certain conditions, the system may not adjust the vehicle speed until after your vehicle passes the speed limit.

Detection of road geometry operates only where related information is available. Road geometry information may not be available in some areas.

SWITCHING PREDICTIVE SPEED ASSIST MODE ON AND OFF

1. From the driver assistance menu, press Cruise Control. See **Driver Assistance Menu** (page 560).
2. Press Adaptive Cruise Control.
3. Switch Predictive Speed Assist on or off.

ADJUSTING THE SET SPEED TOLERANCE

1. From the driver assistance menu, press Cruise Control. See **Driver Assistance Menu** (page 560).
2. Press Adaptive Cruise Control.
3. Switch Predictive Speed Assist on.
4. Press Tolerance.
5. Adjust the slider to set the tolerance.

Note: *You can set tolerance for vehicle speed adjustment based on speed sign recognition only.*

PREDICTIVE SPEED ASSIST ALERTS

If the speed sign recognition system detects a speed limit below the minimum adaptive cruise control set speed, a tone sounds and the system returns to standby mode.

PREDICTIVE SPEED ASSIST INDICATORS

A blue marker around the speed sign and a blue arrow next to the set speed indicates that the system is active.



Adaptive Cruise Control (If Equipped)

Speed sign indicator

When the system detects a new speed sign, a gray indicator appears above the set speed while the system adjusts the vehicle speed to the speed limit. When the speed limit is reached, the set speed updates and the gray indicator disappears.

Road geometry indicator

When the system detects a curve or highway exit, the vehicle starts to decelerate, and the indicator appears and changes color.

Road geometry indicator symbols



Left curve.



Right curve.

PREDICTIVE SPEED ASSIST – TROUBLESHOOTING (IF EQUIPPED)

PREDICTIVE SPEED ASSIST – INFORMATION MESSAGES

Message	Details
Adaptive Cruise Control Speed Sign Recognition Not Available	Navigation system based speed limit information is not available. If the message continues to appear, have your vehicle checked as soon as possible.
Driver Resume Control	The system is going to cancel and you must take control.

ADAPTIVE CRUISE CONTROL – TROUBLESHOOTING

ADAPTIVE CRUISE CONTROL – INFORMATION MESSAGES - VEHICLES WITH: STOP AND GO

Note: Depending on your vehicle options and instrument cluster type, not all messages display or are available.

Note: The system could abbreviate or shorten certain messages depending upon which cluster type you have.

Adaptive Cruise Control (If Equipped)

Message	Details
Front Sensor Not Aligned	Contact an authorized dealer to have the radar checked for proper coverage and operation.
Cruise Control Not Available	Conditions exist preventing the system from being available.
Adaptive Cruise Control Not Available Sensor Blocked See Manual	You have a blocked radar because of poor radar visibility due to inclement weather or ice, mud, or water in front of the sensor. You can typically clean the sensor to resolve this issue. Due to the nature of sensor technology, it is possible to get a blockage warning with no actual block. This happens, for example, when driving in sparse rural or desert environments. A false blocked condition either self clears, or clears after you restart your vehicle.
Normal Cruise Active Adaptive Braking Off	You have selected normal cruise control. The system does not brake or react to traffic.
Adaptive Cruise - Driver Resume Control	Displays when the adaptive cruise control is going to cancel and you must take control.
Cruise Control Speed Too Low to Activate	Displays when the vehicle speed is too slow to activate the adaptive cruise control and there is no lead vehicle in range.

ADAPTIVE CRUISE CONTROL VIDEOS

[Adaptive Cruise Control with Stop and Go and Lane-Centering Assist](#)

Drive Mode Control

WHAT IS DRIVE MODE CONTROL

This feature connects multiple vehicle systems through a single interface, providing you with enhanced vehicle control and driving dynamics for different driving scenarios, terrains, weather, or various road conditions.

HOW DOES DRIVE MODE CONTROL WORK

When a drive mode is selected it alters various electrical and mechanical systems within the vehicle to a predetermined configuration. The systems altered and features available depend on which mode is selected.

Note: The electronic locking differential is available and automatically engages in some drive modes. See **Electronic Locking Differential** (page 247).

Note: Your vehicle automatically starts in the last selected drive mode, for applicable modes, when you return to your vehicle after short trips up to 2 hours between ignition cycles. At startup, the system displays a prompt on the instrument cluster display that gives you the option to return to the last drive mode that you chose prior to shutting the vehicle off. The system returns to the last selected drive mode and the default four-wheel drive mode associated with that mode.

SELECTING A DRIVE MODE



Rotate the controller located on the center console. Rotate the drive mode controller once to activate the drive mode selection menu in the display. Rotate the controller a second time to select and engage the drive mode.

Note: Button icons vary depending on the vehicle's configuration.

DRIVE MODES

ECO - 4X4



This mode decreases accelerator pedal responsiveness to soften driver inputs and encourage efficient driving.

Depending on your vehicle's options, adaptive cruise control is slower to return to the set speed and auto-start-stop engages more often. The system decreases air conditioning output to conserve energy when set to auto mode.

Drive Mode Control

Use this mode for fuel efficient driving which allows for an extended vehicle range.

Note: Two-wheel drive high (2H) is the default four-wheel drive mode. Four-wheel drive low (4L) is not available.

Note: The electronic locking differential is available below 25 mph (40 km/h). See **Switching the Electronic Locking Differential On and Off** (page 247).

ECO - 4X2



This mode decreases accelerator pedal responsiveness to soften driver inputs and encourage efficient driving.

Depending on your vehicle's options, adaptive cruise control is slower to return to the set speed and auto-start-stop engages more often. The system decreases air conditioning output to conserve energy when set to auto mode.

Use this mode for fuel efficient driving which allows for an extended driving range.

Note: The electronic locking differential is available below 25 mph (40 km/h). See **Switching the Electronic Locking Differential On and Off** (page 249).

NORMAL - 4X4



This mode adjusts all systems to their base settings and balances vehicle performance for all around drivability. Each time you switch your vehicle off it defaults to this mode.

Use this mode for everyday driving, such as city and highway routes or commuting.

Note: Two-wheel drive high (2H) is the default four-wheel drive mode. All four-wheel drive modes are selectable when in normal mode.

Note: The electronic locking differential is available below 25 mph (40 km/h). See **Switching the Electronic Locking Differential On and Off** (page 247).

NORMAL - 4X2



This mode adjusts all systems to their base settings and balances vehicle performance for all around drivability. Each time you switch your vehicle off it defaults to this mode.

Use this mode for everyday driving, such as city and highway routes or commuting.

Note: The electronic locking differential is available below 25 mph (40 km/h). See **Switching the Electronic Locking Differential On and Off** (page 249).

OFF-ROAD - 4X4



This mode lowers accelerator pedal responsiveness and delays transmission upshifts for improved vehicle control in low speed off-road environments. Traction and stability controls allow the wheels to spin to maintain vehicle momentum and clear debris from the tires for improved traction.

Depending on your vehicle's options, the system inhibits auto start stop and engages the rear electronic locking differential.

Use this mode for driving through mud, sand, and rough, uneven off-road terrains.

Note: Four-wheel drive high (4H) is the default four-wheel drive mode. Depending on your vehicle options, four-wheel drive auto (4A) or two-wheel drive high (2H) is not available.

Drive Mode Control

Note: The electronic locking differential engages when you select this mode at any speed, and you can disengage it at any time using the button. See **Switching the Electronic Locking Differential On and Off** (page 247).

Note: This mode is for Off-Road use only. Do not use this mode when driving on pavement. Depending on the four-wheel drive mode selection, this could cause driveline bind up and damage the system. See **Four-Wheel Drive** (page 231).

ROCK CRAWL



This mode lowers accelerator pedal responsiveness and holds the transmission in lower gears to enhance vehicle control for low speed rock crawling. The system switches the traction and stability controls to their rock crawl settings.

Depending on your vehicle's options, this feature inhibits auto start stop and engages the rear electronic locking differential.

Use this mode when crossing aggressive terrain including rocks, mountain trails, and boulders.

Note: Four-wheel drive low (4L) is the only four-wheel drive mode available.

Note: This mode is for Off-Road use only. Do not use this mode when driving on pavement. This could cause driveline bind up and damage the system depending on the four-wheel drive mode you select. See **Four-Wheel Drive** (page 231).

SLIPPERY - 4X4



This mode lowers accelerator pedal responsiveness, adjusts transmission shift points, and optimizes traction and stability controls to help mitigate wheel spin and maintain vehicle control in slick driving conditions.

Depending on your vehicle's options, this feature adjusts all-wheel drive control to provide optimum traction for slippery surfaces.

Use this mode for less than ideal road conditions such as snow and ice covered roads or for firm surfaces that are covered with loose or slippery materials.

Note: Four-wheel drive high (4H) is the default four-wheel drive mode. All four-wheel drive modes are selectable.

Note: The electronic locking differential is available below 25 mph (40 km/h). See **Switching the Electronic Locking Differential On and Off** (page 247).

Note: Do not use this mode when driving on dry pavement. This could cause driveline bind up and damage the system depending on the four-wheel drive mode you select. See **Four-Wheel Drive** (page 231).

SLIPPERY - 4X2



This mode lowers accelerator pedal responsiveness, adjusts transmission shift points, and optimizes traction and stability controls to help mitigate wheel spin and maintain vehicle control in slick driving conditions.

Depending on your vehicle's options, this feature adjusts all-wheel drive control to provide optimum traction for slippery surfaces.

Use this mode for less than ideal road conditions such as snow and ice covered roads or for firm surfaces that are covered with loose or slippery materials.

Drive Mode Control

Note: The electronic locking differential is available below 25 mph (40 km/h). See **Switching the Electronic Locking Differential On and Off** (page 249).

TOW/HAUL - 4X4



For improved vehicle operation when towing a trailer or hauling a heavy load. This mode moves upshifts to higher engine speeds to reduce the frequency of transmission shifting. It also provides downshift engine braking to assist in maintaining vehicle speed when descending a slope.

Depending on your vehicle's options, the system enhances steering response to assist in controlling the vehicle when towing or hauling and auto-start stop is inhibited.

Note: All four-wheel drive modes are selectable. This mode does not default to a certain four-wheel drive mode and maintains the previous selection.

Note: The electronic locking differential is available below 25 mph (40 km/h). See **Switching the Electronic Locking Differential On and Off** (page 247).

TOW/HAUL - 4X2



For improved vehicle operation when towing a trailer or hauling a heavy load. This mode moves upshifts to higher engine speeds to reduce the frequency of transmission shifting. It also provides downshift engine braking to assist in maintaining vehicle speed when descending a slope.

Depending on your vehicle's options, the system enhances steering response to assist in controlling the vehicle when towing or hauling and auto-start stop is inhibited.

Note: The electronic locking differential is available below 25 mph (40 km/h). See **Switching the Electronic Locking Differential On and Off** (page 249).

TRAIL - 4X2



This mode lowers accelerator pedal responsiveness and delays transmission up-shifts for improved vehicle control in low speed off-road environments. The system optimizes the traction and stability controls for improved traction and to help maintain forward momentum through loose deformable terrains.

Depending on your vehicle's options, the system disables auto-start-stop and optimizes the all-wheel drive system for enhanced traction.

Use this mode for driving on two-track trails, loose gravel and mixed uneven terrain.

Note: The electronic locking differential is available below 25 mph (40 km/h). See **Switching the Electronic Locking Differential On and Off** (page 249).

DRIVE MODE CONTROL – TROUBLESHOOTING

DRIVE MODE CONTROL – WARNING LAMPS



Some drive modes reduce traction and stability control performance and the indicator illuminates in the instrument cluster.

Drive Mode Control

Note: *The system has diagnostic checks that continuously monitor the system for proper operation. If a mode is unavailable due to a system fault, the drive mode system defaults to normal. When the system defaults to normal, the driveline settings remain the same as prior to the system fault.*

DRIVE MODE CONTROL – INFORMATION MESSAGES

Message	Details
Selected 4x4 Mode Not Available in Current Drive Mode	You have selected a four-wheel drive mode that is not available in the current drive mode. Select an available four-wheel drive mode.

Drive Mode Control

DRIVE MODE CONTROL – FREQUENTLY ASKED QUESTIONS

Why did the system default to normal mode?

- If a mode is unavailable due to a system fault, it defaults to normal mode and the driveline settings remain the same as prior to the system fault.

Can I switch drive modes while I am driving?

- In most instances, you can switch drive modes while you are driving (if you maintain attention on the road), or while the vehicle is stationary. However, you should not switch the vehicle into a drive mode intended for off-road or track use while driving on paved, public roads. For example, while driving on a paved highway, it would be acceptable to switch from normal mode to eco mode, but not to off-road mode.

How long does it take for the vehicle to switch modes after I make a selection?

- After switching modes, the new drive mode will activate within several seconds, if all the appropriate pre-conditions are met.

How should I decide which drive mode to use?

- Selecting a drive mode usually depends on the driving experience you would like to have, and the driving conditions. For example, if you want to have a more exciting on-road driving experience, you could switch into sport mode. If you find yourself driving on slick roads, you could switch into slippery mode.

Will drive modes impact my vehicle's fuel consumption?

- Drive modes can have an impact on your vehicle's fuel consumption. In addition to the active mode, your driving style will also affect the fuel consumption.

Lane Keeping System (If Equipped)

WHAT IS THE LANE KEEPING SYSTEM

The lane keeping system alerts you by providing temporary steering assistance or steering wheel vibration when it detects an unintended lane departure.

HOW DOES THE LANE KEEPING SYSTEM WORK

The lane keeping system uses a forward looking camera mounted on the windshield to monitor vehicle movement within the lane of travel.

When the camera detects a drift out of the lane of travel, the lane keeping system alerts the driver by vibrating the steering wheel, or aids the driver by providing a small steering input to move the vehicle back into the lane of travel.

The driver can select one of three modes:

- Alert (if equipped)
- Aid
- Alert + Aid

LANE KEEPING SYSTEM PRECAUTIONS

 **WARNING:** You are responsible for controlling your vehicle at all times. The system is designed to be an aid and does not relieve you of your responsibility to drive with due care and attention. Failure to follow this instruction could result in the loss of control of your vehicle, personal injury or death.

 **WARNING:** The system will not operate if the sensor cannot track the road lane markings.

 **WARNING:** The sensor may incorrectly track lane markings as other structures or objects. This can result in a false or missed warning.

 **WARNING:** In cold and severe weather conditions the system may not function. Rain, snow and spray can all limit sensor performance.

 **WARNING:** The system may not operate properly if the sensor is blocked. Keep the windshield free from obstruction.

 **WARNING:** If damage occurs in the immediate area surrounding the sensor, have your vehicle checked as soon as possible.

 **WARNING:** The system may not correctly operate if your vehicle is fitted with a suspension kit not approved by us.

 **WARNING:** Large contrasts in outside lighting can limit sensor performance.

LANE KEEPING SYSTEM LIMITATIONS

The lane keeping system only operates when the vehicle speed is greater than 64 km/h (40 mph).

The system works when the camera can detect at least one lane marking or the edge of the road.

Lane Keeping System (If Equipped)

Note: When you select Aid or Alert and Aid mode and the system detects no steering activity for a short period of time, the system alerts you to put your hands on the steering wheel. The system may detect a light grip or touch on the steering wheel as hands-off driving.

The lane keeping system may not correctly operate in any of the following conditions:

- The lane keeping system does not detect at least one lane marking or the edge of the road.
- You switch the turn signal on.
- You apply direct steering, accelerate fast or brake hard.
- The vehicle speed is less than 64 km/h (40 mph).
- The anti-lock brake, stability control or traction control system activates.
- The lane is too narrow.
- Something is obscuring the camera or it is unable to detect the lane markings due to environment, traffic or vehicle conditions.
- Entering or exiting a tight curve when driving at high speeds.

The lane keeping system may not correct lane positioning in any of the following conditions:

- High winds.
- Uneven road surfaces.
- Heavy or uneven loads.
- Incorrect tire pressure.

SWITCHING THE LANE KEEPING SYSTEM ON AND OFF



To activate the lane keeping system, press the button on the steering wheel.

To deactivate the lane keeping system, press the button again.

Note: When switching the system on or off a message appears in the instrument cluster display to show the status.

Note: The system stores the on or off setting until manually changed. For some markets, the system defaults to the ON setting at every ignition cycle.

SWITCHING THE LANE KEEPING SYSTEM MODE

1. From the driver assistance menu, press Lane Keeping System. See **Driver Assistance Menu** (page 560).
2. Press Lane-Keeping Mode.
3. Select a mode.

Note: The system remembers the last setting when you start your vehicle.

LANE KEEPING SYSTEM SETTINGS

Adjusting the Steering Wheel Vibration Intensity

1. From the driver assistance menu, press Lane Keeping System. See **Driver Assistance Menu** (page 560).
2. Press Lane Keeping Intensity.
3. Select a setting.

Note: This setting is not available in all modes.

ALERT MODE

WHAT IS ALERT MODE

Alert mode vibrates the steering wheel when it detects an unintended lane departure.

Lane Keeping System (If Equipped)

HOW DOES ALERT MODE WORK

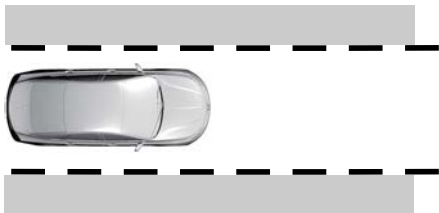

When in alert mode, the lane keeping system alerts you by vibrating the steering wheel. The intensity of the vibration is set through the lane keeping system menu.

AID MODE

WHAT IS AID MODE

Aid mode provides temporary steering assistance toward the center of the lane.

HOW DOES AID MODE WORK

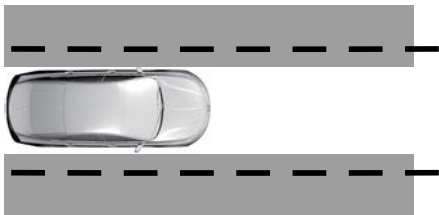

The lane keeping system aids you when an unintentional lane departure occurs. The system provides a small steering input to move the vehicle towards the center of the lane.

ALERT AND AID MODE

WHAT IS ALERT AND AID MODE

Alert and aid mode uses multiple features to keep you in your lane. The system first provides a small steering input to bring your vehicle back towards the center of the lane. If your vehicle moves too far from the center of the lane the system alerts you with vibration in the steering wheel.

HOW DOES ALERT AND AID MODE WORK

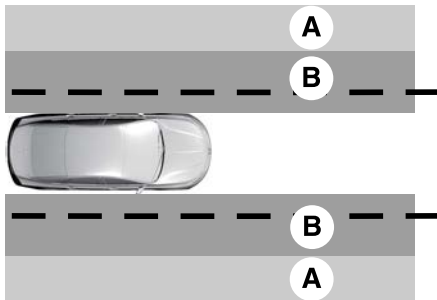

- A Alert.
- B Aid.

The lane keeping system detects a lane departure and provides aid when the vehicles enters **B** and applies the additional alert warning if **A** is entered.

Lane Keeping System (If Equipped)

LANE KEEPING SYSTEM INDICATORS

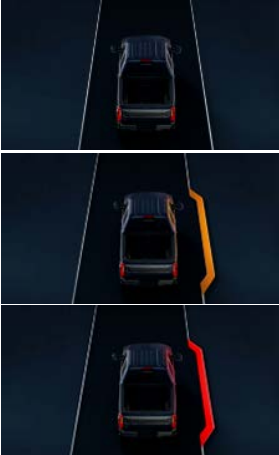

If you switch the lane keeping system on, a graphic with lane markings and an activation icon appear in the instrument cluster display.

When you switch the system off, the lane marking graphics do not display.

Note: *The overhead vehicle graphic may still display if adaptive cruise control is enabled.*

When the lane keeping system is on, the color of the lane markings change to indicate the system status.

Gray	Green	Yellow	Red
Indicates that the system is temporarily unavailable to provide a warning or intervention on the indicated side.	Indicates that the system is available or ready to provide a warning or intervention on the indicated side.	Indicates that the system is providing or has just provided a lane keeping aid intervention.	Indicates that the system is providing or has just provided a lane keeping alert warning.

BLIND SPOT ASSIST (IF EQUIPPED)

WHAT IS BLIND SPOT ASSIST

Blind spot assist is an extension of the lane keeping system.

It may help you identify adjacent vehicles during a lane change.

Blind spot assist provides a blind spot warning and steering assistance to help you become aware of and steer away from vehicles in your blind spot during lane changes.

HOW DOES BLIND SPOT ASSIST WORK



Activate and deactivate the system using the lane keeping system button on the steering wheel.

Lane Keeping System (If Equipped)

During lane changes, the design of the blind spot assist feature detects vehicles in, or approaching, your blind spot and provides a warning, plus steering assistance to direct your vehicle back into your lane.

When active, this system functions with or without the use of turn signals and hazard flashers.

You must keep your hands on the steering wheel at all times.

BLIND SPOT ASSIST LIMITATIONS

All system limitations present in the basic lane keeping system also apply to blind spot assist.

Blind spot assist does not function under the following conditions:

- No lane markings are detected.
- One or both rear radar sensors become blocked or faulty.
- Attaching bike or cargo racks could cause false alerts due to obstruction of the sensor.

Blind spot assist may have difficulty detecting hazards under the following conditions:

- If a vehicle is approaching in an adjacent lane at a speed higher than your vehicle.
- Bad weather obstructing the sensors.

BLIND SPOT ASSIST WITH TRAILER COVERAGE (IF EQUIPPED)

WHAT IS BLIND SPOT ASSIST WITH TRAILER COVERAGE

Blind spot assist with trailer coverage is an extension of the lane keeping system.

It may help you identify adjacent vehicles during a lane change.

Blind spot assist provides a blind spot warning and steering assistance to help you become aware of and steer away from vehicles in your blind spot during lane changes.

When attaching a trailer, ensure you have properly set up the trailer coverage settings. See **Blind Spot Information System With Trailer Coverage** (page 327).

HOW DOES BLIND SPOT ASSIST WITH TRAILER COVERAGE WORK



Activate and deactivate the system using the lane keeping system button on the steering wheel.

During lane changes, the design of the blind spot assist feature detects vehicles in, or approaching, your blind spot and provides a warning, plus steering assistance to direct your vehicle back into your lane.

If a supported trailer is connected, the function is reduced to only detecting vehicles on both sides of your vehicle and trailer, extending rearward from the exterior mirrors to the end of your trailer. See **Blind Spot Information System** (page 326).

When active, this system functions with or without the use of turn signals and hazard flashers.

You must keep your hands on the steering wheel at all times.

Lane Keeping System (If Equipped)

BLIND SPOT ASSIST WITH TRAILER COVERAGE LIMITATIONS

All system limitations present in the basic lane keeping system also apply to blind spot assist.

Blind spot assist does not function under the following conditions:

- No lane markings are detected.
- One or both rear radar sensors become blocked or faulty.
- You have not configured the attached trailer correctly in the trailer tow menus or you attached an unsupported trailer. The system only supports certain trailer shapes and dimensions.

Note: Blind spot assist with trailer coverage could have reduced performance if any of the above limitations are present.

Blind spot assist may have difficulty detecting hazards under the following conditions:

- If a vehicle is approaching in an adjacent lane at a relative speed much higher than your vehicle.
- Bad weather conditions are present that obstruct the sensors.
- Attaching bike or cargo racks could cause false alerts due to obstruction of the sensor.

BLIND SPOT ASSIST WITH TRAILER COVERAGE INDICATORS

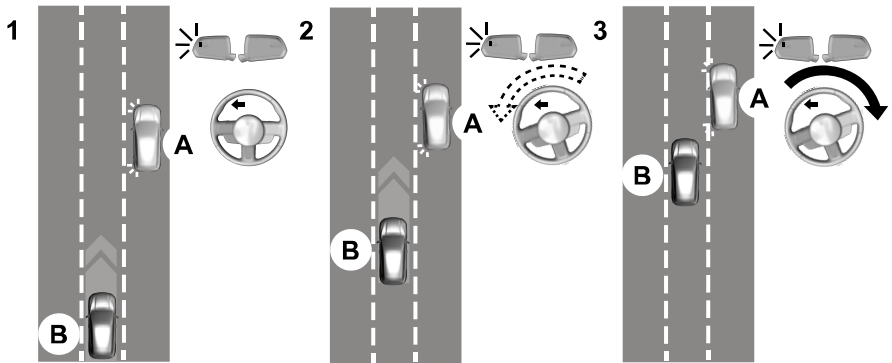

Diagram 1: Vehicle A uses its left turn signal preparing to change from the right lane to the middle lane. Vehicle B is already in the middle lane and just entered Vehicle A's blind spot causing the blind spot information system alert indicator to flash on the exterior mirror.

Diagram 2: The driver of Vehicle A begins to steer into the center lane not aware of Vehicle B.

Diagram 3: Blind spot assist counter steers to help alert the driver of Vehicle A to direct their vehicle back into the right lane to help avoid a possible collision with Vehicle B.

Lane Keeping System (If Equipped)

The lane keeping aid warning lamp or yellow lane marking in your instrument cluster display indicate blind spot assist activation. In addition, the blind spot

information system alert indicator flashes on the exterior mirror on the same side as the detection. See **Blind Spot Information System** (page 326).

Blind Spot Assist Information Messages

Message	Action
Blind Spot Assist Not Available Trailer Attached	Displays if you attach a trailer to your vehicle with the blind spot information system switched off or you have not configured the trailer.
Blind Spot Assist Not Available Side Sensor Blocked	Displays if your blind spot information system sensors are blocked.
Blind Spot Assist System fault	The system has detected a fault that requires service. Have your vehicle checked as soon as possible.
Trailer Brake Module Fault	Lost communication with the trailer module. Blind spot assist is disabled until the failure is fixed.
Trailer Lighting Module Fault See Manual	Lost communication with the trailer module. Blind spot assist is disabled until the failure is fixed.
Front Camera Fault Service Required	Front camera fault. Blind spot assist is disabled until the failure is fixed.

Lane Keeping System (If Equipped)

LANE KEEPING SYSTEM – TROUBLESHOOTING

LANE KEEPING SYSTEM – INFORMATION MESSAGES

Message	Action
Lane Keeping Sys. Malfunction Service Required	The system has malfunctioned. Have your vehicle checked as soon as possible.
Front Camera Temporarily Not Available	The system has detected a condition that has caused the system to be temporarily unavailable.
Front Camera Low Visibility Clean Screen	The system has detected a condition that requires you to clean the windshield in order for it to operate properly.
Front Camera Malfunction Service Required	The system has malfunctioned. Have your vehicle checked as soon as possible.
Keep Hands on Steering Wheel	The system requests that you keep your hands on the steering wheel.

Lane Keeping System (If Equipped)

LANE KEEPING SYSTEM – FREQUENTLY ASKED QUESTIONS

Why is the feature not available (lane markings are gray) when I can see the lane markings on the road?
Your vehicle speed is less than 65 km/h (40 mph).
The sun is shining directly into the camera lens.
A quick intentional lane change has occurred.
Your vehicle stays too close to the lane markings for an extended interval of time.
Driving at high speeds in curves.
The last alert warning or aid intervention occurred a short time ago.
Ambiguous lane markings, for example, in construction zones.
Rapid transition from light to dark, or from dark to light.
Sudden offset in lane markings.
ABS or AdvanceTrac™ is active.
There is a camera blockage due to dirt, grime, fog, frost or water on the windshield.
You are driving too close to the vehicle in front of you.
Transitioning between no lane markings to lane markings, or vice versa.
There is standing water on the road.
Faint lane markings, for example, partial yellow lane markings on concrete roads.
Lane width is too narrow or too wide.
You have not calibrated the camera after a windshield replacement.
Driving on tight or on uneven roads.

Lane Keeping System (If Equipped)

Why does the vehicle not come back toward the middle of the lane, as expected, in the Aid, or Aid + Alert mode?
High cross winds are present.
There is a large road crown.
Rough roads, grooves or shoulder drop-offs.
Heavy, uneven loading of the vehicle or improper tire inflation pressure.
You changed the tires or modified the suspension.

Blind Spot Information System (If Equipped)

WHAT IS BLIND SPOT INFORMATION SYSTEM

Blind spot information system detects vehicles that may have entered the blind spot zone.

HOW DOES BLIND SPOT INFORMATION SYSTEM WORK

Blind spot information system uses sensors on both sides of your vehicle, detecting rearward from the exterior mirrors to approximately 4 m (13 ft) beyond the rear bumper. The detection area extends to approximately 18 m (59 ft) beyond the rear bumper when the vehicle speed is greater than 48 km/h (30 mph) to alert you of faster approaching vehicles.

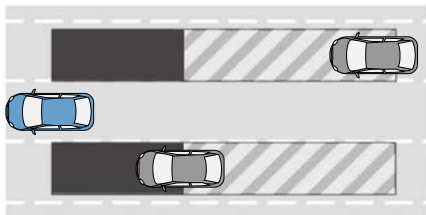

BLIND SPOT INFORMATION SYSTEM PRECAUTIONS



WARNING: Do not use the blind spot information system as a replacement for using the interior and exterior mirrors or looking over your shoulder before changing lanes. The blind spot information system is not a replacement for careful driving.



WARNING: The system may not operate properly during severe weather conditions, for example snow, ice, heavy rain and spray. Always drive with due care and attention. Failure to take care may result in a crash.

Note: *Blind spot information system does not prevent contact with other vehicles. It does not detect parked vehicles, pedestrians, animals or other infrastructure.*

BLIND SPOT INFORMATION SYSTEM LIMITATIONS

Blind spot information system does not operate in park (P) or reverse (R).

The system may not alert you if a vehicle quickly passes through the detection zone while overtaking.

Note: *For vehicles without the trailer coverage feature, we recommend that you switch the blind spot information system off when you attach a trailer.*

BLIND SPOT INFORMATION SYSTEM REQUIREMENTS

Blind spot information system turns on when all the following occur:

- You start your vehicle.
- You shift into drive (D).
- The vehicle speed is greater than 10 km/h (6 mph).

Blind Spot Information System (If Equipped)

SWITCHING BLIND SPOT INFORMATION SYSTEM ON AND OFF

1. From the driver assistance menu, press Blind Spot Information System. See **Driver Assistance Menu** (page 560).
2. Switch Blind Spot Information System on or off.

When you switch the blind spot information system off, a warning lamp illuminates. When you switch the system on or off, the alert indicators flash twice. A telltale remains illuminated in the instrument cluster when you switch the blind spot information system off in the settings menu.

Note: *The system remembers the last setting when you start your vehicle.*

LOCATING THE BLIND SPOT INFORMATION SYSTEM SENSORS

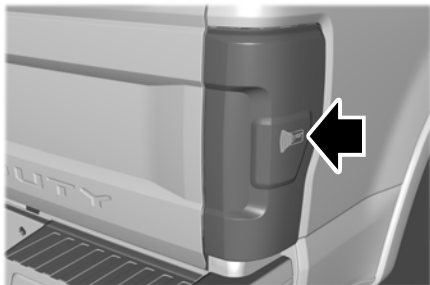

The sensors are inside the brake lamp on both sides of your vehicle.

Note: *Keep the sensors free from snow, ice and large accumulations of dirt.*

Note: *Do not cover the sensors with bumper stickers, repair compound or other objects.*

Note: *Bike and cargo racks could cause false alerts due to obstruction of the sensor. We recommend switching the feature off when using a bike or cargo rack.*

Note: *Blocked sensors may affect system accuracy.*

If the sensors become blocked, a message appears in the instrument cluster display. See **Blind Spot Information System – Information Messages** (page 329). The alert indicators illuminate but the system does not alert you.

BLIND SPOT INFORMATION SYSTEM WITH TRAILER COVERAGE

WHAT IS BLIND SPOT INFORMATION SYSTEM WITH TRAILER COVERAGE

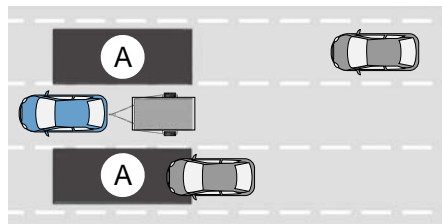

A. Trailer coverage detection zone.

Blind spot information system detects vehicles that may have entered the blind spot zone. The detection area is on both sides your vehicle and trailer, extending rearward from the exterior mirrors to the end of your trailer.

Blind Spot Information System (If Equipped)

BLIND SPOT INFORMATION SYSTEM WITH TRAILER COVERAGE LIMITATIONS

Trailer coverage automatically supports conventional trailers. To function with unconventional trailers such as fifth wheel and gooseneck variants, the vehicle needs to have trailer accessory sensors connected.

Make sure the trailer width is less than or equal to 2.6 m (8.5 ft) and the length is less than 10.1 m (33 ft) for conventional trailers and less than 15.2 m (50 ft) for unconventional trailers. If you input values higher, the system turns off.

Some trailers could cause a slight change in system performance:

- Large box trailers, including v-nose or horse trailers, could cause false alerts to occur when driving next to infrastructures or near parked cars. A false alert could also occur while making a 90° turn.
- Trailers that have a width greater than 2.6 m (8.5 ft) at the front and have a total length greater than 6 m (20 ft) could cause delayed alerts when a vehicle is passing at high speeds.
- Box trailers that have a width greater than 2.6 m (8.5 ft) at the front could cause early alerts when you pass a vehicle.
- Clam shell or v-nose box trailers with a width greater than 2.6 m (8.5 ft) at the front could cause delayed alerts when a vehicle traveling the same speed as your vehicle merges lanes.

Please contact your dealership for more information about trailer blind spot accessory sensors.

SETTING A TRAILER LENGTH

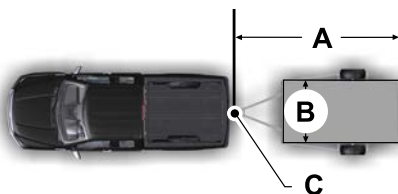

- A Trailer length.
- B Trailer width.
- C Trailer hitch ball.



Note: Measure the entire trailer length when setting up a gooseneck or fifth wheel trailer.

You can set-up a trailer to work with the blind spot information system through the touchscreen by using the add trailer menu.

1. Input the trailer name and trailer type, conventional, gooseneck or fifth wheel, then save to continue trailer setup.
2. Trailer width measurement. Measure the width at the front of the trailer. It is not measured at the widest point of the trailer. The maximum width at the front of the trailer the system can support is 2.6 m (8.5 ft).

Note: If the trailer is a bike rack or cargo rack with electrical lighting, enter a length of around 1 m (3 ft). Cross traffic alert remains on for trailers with a length of 1 m (3 ft) or less.

Blind Spot Information System (If Equipped)

Note: The system requires proper measurement and measure entry to properly function.

SELECTING A TRAILER

When you connect a trailer to your vehicle, the trailer set up menu appears in the touchscreen. This menu allows you to set up a new trailer or choose from a previously set up trailer. A warning message appears and the system turns off if you do not choose or add a new trailer.

Note: The warning message may not appear until your vehicle reaches 35 km/h (22 mph).

BLIND SPOT INFORMATION SYSTEM INDICATORS



When the blind spot information system detects a vehicle, an alert indicator illuminates in the exterior mirror on the side from which the vehicle is approaching. If you switch the turn signal on for that side of your vehicle, the alert indicator flashes.



When you switch blind spot information system off, a warning lamp illuminates. When you switch the system on or off, the alert indicators flash twice. A telltale remains illuminated in the instrument cluster when the blind spot information system is switched off in the settings menu.

BLIND SPOT INFORMATION SYSTEM – TROUBLESHOOTING

BLIND SPOT INFORMATION SYSTEM – INFORMATION MESSAGES

Message	Action
Blind Spot System Fault	A fault with the system has occurred. Have your vehicle checked as soon as possible.
Blind Spot Not Available Sensor Blocked See Manual	Something is blocking the sensors. Clean the sensors.
Blind Spot Alert Deactivated Trailer Attached	The system automatically turns off and displays this message when you connect a trailer to your vehicle under any of the following conditions: <ul style="list-style-type: none">- Your vehicle does not have blind spot information system with trailer coverage.- You switch the blind spot information system off through the touchscreen.- Your trailer exceeds the limits for the system. See Setting a Trailer Length (page 328). Only appears if your vehicle has blind spot information system with trailer coverage.

Blind Spot Information System (If Equipped)

Note: *When connecting a trailer, the system may detect the trailer and turn the system OFF. If the system does not automatically turn OFF, manually switch the blind spot information system OFF. If your vehicle has the blind spot information system with trailer coverage, the system prompts you to set up a trailer that allows the feature to function, if your trailer meets the requirements of the system.*

Exit Warning (If Equipped)

WHAT IS EXIT WARNING

Exit warning provides a visual and audible alert when a vehicle occupant opens a door into approaching traffic. It uses radar sensors to alert you to traffic objects.

HOW DOES EXIT WARNING WORK

Exit warning detects traffic objects such as vehicles, cyclists, scooters and motorcycles that approach your vehicle from the rear and cross into the exit warning zone. The exit warning zones are along the left and right sides of your vehicle and extend slightly past a fully open door. The exit warning system becomes active once you have started your vehicle and the vehicle is not moving. Exit warning operates in any gear position.



Note: The system cannot detect animals, slow moving pedestrians or any type of stationary object.

EXIT WARNING PRECAUTIONS



WARNING: The system is not a crash warning or avoidance system.



WARNING: Always pay attention to the traffic situation and the area around the vehicle.



WARNING: In cold and severe weather conditions the system may not function. Rain, snow and spray can all limit sensor performance.



WARNING: If damage occurs in the immediate area surrounding the sensor, have your vehicle checked as soon as possible.



WARNING: You are responsible for controlling your vehicle at all times. The system is designed to be an aid and does not relieve you of your responsibility to drive, stop and park with due care and attention. Failure to follow this instruction could result in the loss of control of your vehicle, personal injury or death.



WARNING: Exit Warning may not detect objects with surfaces that absorb reflection. Always open doors with due care and attention. Failure to follow this instruction may result in personal injury or property damage.

EXIT WARNING LIMITATIONS

The exit warning system is operational in any gear position once you start your vehicle and anytime the vehicle is not moving. The exit warning system remains on for about 3 minutes after turning your vehicle off. The system immediately turns off when locking the doors. Exit warning informs you when it turns off.

Note: Do not use exit warning as a replacement for paying attention when exiting your vehicle.

Exit Warning (If Equipped)

Note: The system does not prevent contact with other vehicles by automatically closing the doors.

Note: The system may not inform and/or alert you if a traffic object is approaching too quickly or if the parking position prevents detection.

Exit Warning Alert

Note: Exit warning is designed to provide a visual alert during an exit when an occupant opens any door and a traffic object is approaching on the same side.

EXIT WARNING INDICATORS



When exit warning detects an approaching traffic object on one side, the corresponding alert indicator in the exterior mirror is illuminated. If exit warning alert or the optional exit warning prevention are active, the same alert indicator flashes. See **Blind Spot Information System Indicators** (page 329).

In addition to the mirror indicator there is also visual indicator in the information display noting what side a traffic object has been detected on.

SWITCHING EXIT WARNING ON AND OFF

You can switch off the exit warning system using the touchscreen.

Note: The system remembers the last setting when you start your vehicle.

LOCATING THE EXIT WARNING SENSORS

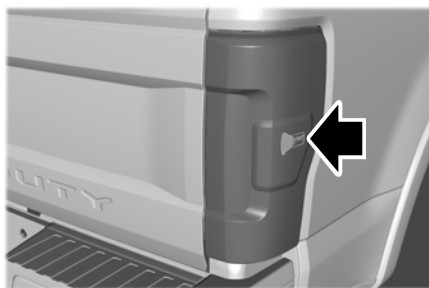

The sensors for exit warning are mounted inside the tail-lamp assembly on both sides of your vehicle.

Note: Keep the sensors free from snow, ice and large accumulations of dirt.

Note: Do not cover the sensors with bumper stickers, repair compound or other objects.

Note: Blocked sensors may affect system accuracy.

Note: The system may not correctly operate when towing a trailer or bike rack.

Exit Warning (If Equipped)

EXIT WARNING – TROUBLESHOOTING

EXIT WARNING – INFORMATION MESSAGES

Message	Reason
Left/Right Side Check surroundings before exiting	Left/Right exit warning alert or exit warning prevention is active.
Exit Warning turning off. Exit safely	Displays when the exit warning system turns off or shuts down.
Exit Warning System Fault	Displays when the exit warning system detects any system error.

If exit warning detects a fault, the system deactivates and a **System Fault** message appears in the instrument cluster display.

Cross Traffic Alert (If Equipped)

WHAT IS CROSS TRAFFIC ALERT

The system is designed to alert you of road users and traffic objects approaching from the rear sides and from behind your vehicle when you shift into reverse (R).

If you continue to reverse after the system alerts you, the system is designed to apply the brakes if it still detects approaching road users or traffic objects. If the system applies the brakes, a message appears in the instrument cluster display.

Note: *There could be instances when unexpected or unwanted braking occurs. You can override this by firmly pressing the accelerator pedal.*

HOW DOES CROSS TRAFFIC ALERT WORK

Cross Traffic Alert is designed to detect road users or traffic objects approaching above a minimum speed of 8 km/h (5 mph). Coverage can decrease when the sensors are partially, mostly or fully obstructed.

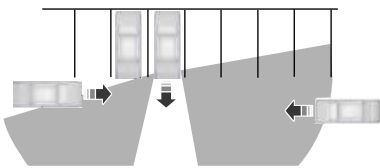

The sensor on the left-hand side is only partially obstructed and zone coverage on the right-hand side is maximized.

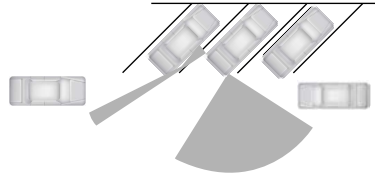

Zone coverage also decreases when parking at narrow angles. The sensor on the left-hand side is mostly obstructed and zone coverage on that side is severely reduced.

Note: *Slowly reversing helps increase the coverage area and effectiveness.*

The system only applies the brakes for a short period of time when an event occurs. Take action as soon as you notice the system applying the brakes in order to remain in control of your vehicle, the system does not do this for you.

CROSS TRAFFIC ALERT PRECAUTIONS





WARNING: You are responsible for controlling your vehicle at all times. The system is designed to be an aid and does not relieve you of your responsibility to drive with due care and attention. Failure to follow this instruction could result in the loss of control of your vehicle, personal injury or death.





WARNING: If damage occurs in the immediate area surrounding the sensor, have your vehicle checked as soon as possible.

Cross Traffic Alert (If Equipped)

 **WARNING:** To help avoid personal injury, always use caution when in reverse (R) and when using the sensing system.

 **WARNING:** The system may not operate properly during severe weather conditions, for example snow, ice, heavy rain and spray. Always drive with due care and attention. Failure to take care may result in a crash.

 **WARNING:** The system may not detect objects with surfaces that absorb reflection. Always drive with due care and attention. Failure to take care may result in a crash.

 **WARNING:** Traffic control systems, fluorescent lamps, inclement weather, air brakes, external motors and fans may affect the correct operation of the sensing system. This may cause reduced performance or false alerts.

 **WARNING:** Some situations and objects prevent hazard detection, for example, inclement weather, unconventional vehicle types and pedestrians. Apply the brakes when necessary. Failure to follow this instruction could result in the loss of control of your vehicle, personal injury or death.

 **WARNING:** Do not use the system with accessories that extend beyond the front or rear of your vehicle, for example a trailer hitch or bike rack. The system is not able to make corrections for the additional length of the accessories.

 **WARNING:** Do not use the cross traffic alert system as a replacement for using the interior and exterior mirrors or looking over your shoulder before reversing out of a parking space. The cross traffic alert system is not a replacement for careful driving.

Note: *Certain add-on devices around the bumper or fascia may cause unexpected system behavior. For example, large trailer hitches, bicycle or surfboard racks, license plate brackets, fuel containers, bumper covers or any other device may block the normal detection zone of the system. Remove the add-on device to prevent unexpected system behavior.*

Note: *If your vehicle sustains damage to the bumper or fascia leaving it misaligned or bent, it could alter the sensing zone causing inaccurate measurement of obstacles or false alerts.*

Note: *Vehicle loading and suspension changes can impact the angle of the sensors and may change the normal detection zone of the system resulting in inaccurate measurement of obstacles or false alerts.*

Note: *You may experience reduced system performance on road surfaces that limit deceleration. For example, roads with ice, loose gravel, mud or sand.*

CROSS TRAFFIC ALERT LIMITATIONS

The system may not correctly operate when any of the following occur:

- Something is blocking the sensors.
- Adjacently parked vehicles or objects are obstructing the sensors.
- Traffic objects approach at speeds less than 8 km/h (5 mph) or greater than 60 km/h (37 mph).

Cross Traffic Alert (If Equipped)

- Your vehicle speed is greater than 12 km/h (7 mph).
- You reverse out of an angled parking space.
- If you switch the traction system off, cross traffic alert does not apply the brakes.

Note: The system does not alert for small stationary and moving objects.

Cross Traffic Alert Limitations with a Trailer Attached

The system remains on when you attach a trailer to vehicles with blind spot information system with trailer coverage under the following conditions:

- You connect a bike rack or cargo rack with a maximum length of 1 m (3 ft).
- You set the trailer length to 1 m (3 ft) in the touchscreen.

Note: The system may not correctly operate when towing a trailer. For vehicles with an approved trailer tow module and tow bar, the system turns off when you attach a trailer greater than 1 m (3 ft). For vehicles with an aftermarket trailer tow module or tow bar, we recommend that you switch the system off when you attach a trailer.

SWITCHING CROSS TRAFFIC ALERT ON AND OFF

1. From the driver assistance menu, press Cross Traffic Alert. See **Driver Assistance Menu** (page 560).
2. Switch the feature on or off.

When you switch the system on or off, the alert indicators flash twice.

Note: The system switches on every time you switch the ignition on.

LOCATING THE CROSS TRAFFIC ALERT SENSORS



The sensors are inside the brake lamp on both sides of your vehicle.

Note: Keep the sensors free from snow, ice and large accumulations of dirt.

Note: Do not cover the sensors with bumper stickers, repair compound or other objects.

Note: Blocked sensors may affect system accuracy.

If something is blocking the sensors, a message may appear in the information display when you shift into reverse (R).

Note: Bike and cargo racks could cause false alerts due to obstruction of the sensor. We recommend switching the feature off when using a bike or cargo rack.

CROSS TRAFFIC ALERT INDICATORS



When the system detects an approaching vehicle, a tone sounds, an alert indicator illuminates in the relevant exterior mirror and arrows appear in the touchscreen to show from which side the vehicle is approaching.

Cross Traffic Alert (If Equipped)

If the system malfunctions, a message appears. Have your vehicle checked as soon as possible.

Note: *In exceptional conditions, the system could alert you or apply the brakes, even when there is nothing in the detection zone, for example a vehicle passing further away from your vehicle.*

CROSS TRAFFIC ALERT – TROUBLESHOOTING

CROSS TRAFFIC ALERT – INFORMATION MESSAGES

Message	Details
Cross Traffic Alert	Displays when the system detects a vehicle. Check for approaching traffic.
Cross Traffic Not Available Sensor Blocked See Manual	Displays if the cross traffic alert system sensors are blocked. Clean the sensors. If the message continues to appear, have your vehicle checked as soon as possible.
Cross Traffic System Fault	The system has malfunctioned. Have your vehicle checked as soon as possible.
Cross Traffic Alert Deactivated Trailer Attached	Displays if you attach a trailer to your vehicle.
Cross Traffic Alert Applying Brakes	Displays if the system applies the brakes. Check for approaching traffic.

Note: *If your vehicle has reverse brake assist See **Reverse Brake Assist – Information Messages** (page 262).*

Pre-Collision Assist (If Equipped)

WHAT IS PRE-COLLISION ASSIST

Pre-collision assist detects and warns of approaching hazards in the roadway. The system provides multiple levels of assistance to help avoid a collision if your vehicle is rapidly approaching another stationary vehicle, a vehicle traveling in the same direction as yours, or a pedestrian or cyclist within your driving path.

HOW DOES PRE-COLLISION ASSIST WORK

The system warns the driver of potential hazards by providing three levels of assistance.

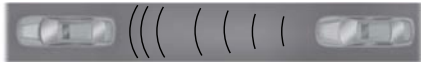

If your vehicle is rapidly approaching potential hazards the system provides the following levels of functionality:

1. Alert.
2. Brake support.
3. Automatic emergency braking.



Alert: When active, a flashing visual warning appears and an audible warning tone sounds.

Brake Support: The system helps reduce the impact speed by preparing the brakes for rapid braking. The system does not automatically apply the brakes. If you press the brake pedal, the system may apply additional braking up to maximum braking force, even if you lightly press the brake pedal.

Automatic Emergency Braking:

Automatic emergency braking may activate if the system determines that a collision is imminent.

Note: If the pre-collision assist alerts are too frequent or disturbing, you can reduce the alert sensitivity. Setting the low sensitivity results in fewer and later warnings of a potential forward collision. The manufacturer recommends using the high sensitivity setting where possible.

Note: Automatic emergency braking performance is not affected by the sensitivity setting.

Each system has various levels of detection capabilities. See **Pre-Collision Assist Limitations** (page 339).

PRE-COLLISION ASSIST PRECAUTIONS



WARNING: You are responsible for controlling your vehicle at all times. The system is designed to be an aid and does not relieve you of your responsibility to drive with due care and attention. Failure to follow this instruction could result in the loss of control of your vehicle, personal injury or death.





WARNING: The system does not detect vehicles moving in a different direction or animals. Apply the brakes when necessary. Failure to follow this instruction could result in the loss of control of your vehicle, personal injury or death.





WARNING: The system does not operate during hard acceleration or steering. Failure to take care may lead to a crash or personal injury.

Pre-Collision Assist (If Equipped)

 **WARNING:** The system may operate with reduced function during cold and inclement weather conditions. Snow, ice, rain, spray and fog can adversely affect the system. Keep the front camera and radar free of snow and ice. Failure to follow this instruction may result in the loss of control of your vehicle, serious personal injury or death.

 **WARNING:** Take additional care if your vehicle is heavily loaded or you are towing a trailer. These conditions could result in reduced performance of this system. Failure to follow this instruction could result in the loss of control of your vehicle, personal injury or death.

 **WARNING:** The system may not function properly if your vehicle is fitted with a replacement windshield not approved by us.

 **WARNING:** Do not perform windshield repairs around the rear-view mirror. Failure to follow this instruction could limit sensor performance.

 **WARNING:** The system cannot help prevent all crashes. Do not rely on this system to replace driver judgment and the need to maintain a safe distance and speed.

 **WARNING:** In situations where the vehicle camera has limited detection capability, this may reduce system performance. These situations include but are not limited to direct or low sunlight, vehicles at night without tail lights, unconventional vehicle types, pedestrians with complex backgrounds,

running pedestrians, partly obscured pedestrians, or pedestrians that the system cannot distinguish from a group. Failure to take care may result in the loss of control of your vehicle, serious personal injury or death.

Note: *Automatic emergency braking may activate when a collision is imminent. The system cannot prevent all crashes, but may reduce crash severity. Do not test automatic emergency braking or forward collision warning. Testing this system must only be conducted by authorized test facilities using specialized equipment. Do not use automatic emergency braking to replace normal braking for any reason. Relying on automatic emergency braking to stop your vehicle may cause an unexpected accident which could lead to serious injury or death.*

PRE-COLLISION ASSIST LIMITATIONS

Pre-collision assist depends on the detection ability of its camera and sensors. Any obstructions or damage to these areas can limit detection or prevent the system from functioning. See **Locating the Pre-Collision Assist Sensors** (page 340).

The system is active at 5 km/h (3 mph) and above.

Note: *The pre-collision assist system automatically disables when you manually disable Advance Trac™, 4X4 low, and Rock Crawl (if available).*

Note: *Brake support and automatic emergency braking are active up to the maximum speed of the vehicle.*

Pedestrian Detection Limitations

Pedestrian detection is active at speeds up to 80 km/h (50 mph).

Pre-Collision Assist (If Equipped)

Pedestrian detection operates optimally when detected hazards are clearly identifiable. System performance may reduce in situations where pedestrians are running, partly obscured, have a complex background, or cannot be distinguished from a group.

Cyclist Detection Limitations

Cyclist detection is active at speeds up to 80 km/h (50 mph).

Cyclist detection functions optimally when detected hazards are clearly identifiable. System performance may reduce in situations where cyclists are fast-moving, partly obscured, have a complex background, or cannot be distinguished from a group.

Intersection Assist (If Equipped)

If your vehicle comes with a radar sensor the pre-collision assist system may operate in a scenario where you are turning across the path of an oncoming vehicle, or with crossing pedestrians. Detection of vehicles driving in an oncoming direction is active if your vehicle is driving at speeds up to 30 km/h (19 mph). Detection of crossing pedestrians at an intersection is active if your vehicle is driving at speeds up to 30 km/h (19 mph).

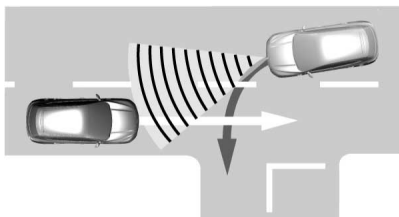

SWITCHING PRE-COLLISION ASSIST ON AND OFF

1. From the driver assistance menu, press Pre-Collision Assist. See **Driver Assistance Menu** (page 560).
2. Switch the feature on or off.

Adjusting the Pre-Collision Assist Settings

You can adjust additional feature settings by using the touchscreen controls in the pre-collision assist menu.

Note: *Automatic emergency braking switches on every time you switch the ignition on.*

LOCATING THE PRE-COLLISION ASSIST SENSORS

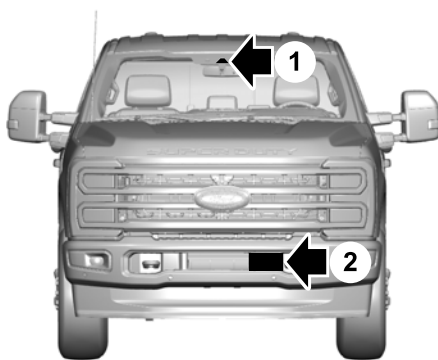

1. Camera.
2. Radar sensor (if equipped).

Pre-Collision Assist (If Equipped)

If a message regarding a blocked sensor or camera appears in the instrument cluster display, something is obstructing the radar or front windshield camera. The radar sensor is behind the fascia cover in the center of the lower grille. With a blocked sensor or camera, the system may not function, or performance may reduce. See **Pre-Collision Assist – Information Messages** (page 344).

Note: Proper system operation requires a clear view of the road by the camera. Have any windshield damage in the area of the camera's field of view repaired.

Note: If something hits the front end of your vehicle or damage occurs and your vehicle has a radar sensor, the radar sensing zone could change. This could cause missed or false vehicle detections. Have your vehicle serviced to have the radar checked for proper coverage and operation.

Note: If your vehicle detects excessive heat at the camera or a potential misalignment condition, a message could appear in the instrument cluster display indicating temporary sensor unavailability. When operational conditions are correct, the message deactivates. For example, when the ambient temperature around the sensor decreases or the sensor successfully recalibrates.

DISTANCE INDICATION

WHAT IS DISTANCE INDICATION

Distance indication displays the gap between your vehicle and the vehicle ahead of you.

Note: The graphic does not display if you switch on cruise control or adaptive cruise control.

Vehicle Speed	System Sensitivity	Distance Indicator Color	Distance Gap	Time Gap
100 km/h (62 mph).	Normal.	Blue.	Greater than 25 m (82 ft).	Greater than 0.9 seconds.
		Yellow.	17–25 m (56–82 ft).	0.6–0.9 seconds.
		Red.	Less than 17 m (56 ft).	Less than 0.6 seconds.

Pre-Collision Assist (If Equipped)

DISTANCE INDICATION INDICATOR

The indicator displays the time gap between your vehicle and vehicles traveling in the same direction ahead of you.



DISTANCE ALERT

WHAT IS DISTANCE ALERT

The system alerts you with a warning lamp if the distance to the vehicle ahead is small.

Note: The warning lamp does not illuminate if cruise control or adaptive cruise control is active.

ADJUSTING THE SENSITIVITY OF DISTANCE ALERT

1. From the driver assistance menu, press Pre-Collision Assist. See **Driver Assistance Menu** (page 560).
2. Press Alert Sensitivity.

AUTOMATIC EMERGENCY BRAKING

WHAT IS AUTOMATIC EMERGENCY BRAKING

Automatic emergency braking may activate if the system determines that a collision is imminent. The system may help to reduce impact damage or completely avoid the crash.

SWITCHING AUTOMATIC EMERGENCY BRAKING ON AND OFF

1. From the driver assistance menu, press Pre-Collision Assist. See **Driver Assistance Menu** (page 560).
2. Press Auto Emergency Braking.
3. Switch the feature on or off.

Note: A telltale remains illuminated in the instrument cluster when automatic emergency braking is switched off using the settings menu.

Note: Automatic emergency braking turns on each time you switch the ignition on.

Note: If you turn automatic emergency braking off, evasive steering assist also turns off.

Pre-Collision Assist (If Equipped)

EVASIVE STEERING ASSIST

WHAT IS EVASIVE STEERING ASSIST

If your vehicle is rapidly approaching a road user, evasive steering assist helps you steer around the road user.

After you turn the steering wheel in an attempt to avoid a crash with the road user, the system applies additional steering torque to help you steer around the road user. After you pass the road user, the system applies steering torque when you turn the steering wheel to steer back into the lane. The system deactivates after you fully pass the road user.

Note: Road users are defined as pedestrians or bicyclists in your vehicle's path or another stationary vehicle in the same lane or a vehicle traveling in the same lane in the same direction as you. See **Pre-Collision Assist Precautions** (page 338).

EVASIVE STEERING ASSIST LIMITATIONS

Evasive steering assist only activates when all the following occur:

- Automatic emergency braking and evasive steering assist are on.
- The system detects a road user ahead and starts to apply the brakes.
- You significantly turn the steering wheel to steer around a road user.

Note: Evasive steering assist does not automatically steer around a road user. If you do not turn the steering wheel, evasive steering assist does not activate.

Note: Evasive steering assist does not activate if the distance to the road user ahead is too small and the system cannot avoid a crash.

SWITCHING EVASIVE STEERING ASSIST ON AND OFF

1. From the driver assistance menu, press Pre-Collision Assist. See **Driver Assistance Menu** (page 560).
2. Press Evasive Steering Assist.
3. Switch the feature on or off.

Note: If you switch automatic emergency braking off, evasive steering assist turns off.

Note: Automatic emergency braking and evasive steering assist turn on every time you start your vehicle.

PRE-COLLISION ASSIST – TROUBLESHOOTING

PRE-COLLISION ASSIST – WARNING LAMPS



A telltale illuminates in the instrument cluster display to indicate if the system is disabled, unavailable, or temporarily degraded due to external environmental conditions.

Note: If the telltale illuminates without a corresponding information message, make sure the setting for automatic emergency braking is switched on. See **Switching Automatic Emergency Braking On and Off** (page 342). No action is needed unless an information message appears. See **Pre-Collision Assist Precautions** (page 338).

Pre-Collision Assist (If Equipped)

PRE-COLLISION ASSIST – INFORMATION MESSAGES

Message	Action
Pre-Collision Assist Not Available Sensor Blocked	You have a blocked sensor due to bad weather, ice, mud or water in front of the radar sensor. You can typically clean the sensor to resolve.
Pre-Collision Assist Not Available	A fault with the system has occurred. Have your vehicle checked as soon as possible.

Pre-Collision Assist (If Equipped)

PRE-COLLISION ASSIST – FREQUENTLY ASKED QUESTIONS

What should I do if the windshield in front of the camera is dirty or obstructed?

- Clean the outside of the windshield in front of the camera.

What if the windshield in front of the camera is clean, but the message remains in the instrument cluster display?

- Wait a short time. It could take several minutes for the camera to detect that there is no obstruction.

What should I do if the surface of the radar in the grille is dirty or obstructed?

- Clean the grille surface in front of the radar or remove the object causing the obstruction.

What if the surface of the radar in the grille is clean, but the message remains in the instrument cluster display?

- Wait a short time. It could take several minutes for the radar to detect that there is no obstruction.

Can weather or road conditions interfere with the radar signals?

- Yes, weather such as heavy rain, spray or fog as well as water, snow or ice on the surface of the road can interfere with the radar signals. In these situations, the system temporarily disables this feature. Pre-collision assist reactivates a short time after the weather conditions improve.

What if the radar is out of alignment due to a front end impact?

- Have your vehicle serviced to have the radar checked for proper coverage and operation.

Speed Sign Recognition (If Equipped)

WHAT IS SPEED SIGN RECOGNITION

Speed sign recognition detects speed limit signs to inform you of the current speed limit. Detected speed signs appear in the instrument cluster display.

HOW DOES SPEED SIGN RECOGNITION WORK

Speed sign recognition uses the front windshield camera to detect speed signs. If your vehicle has speed sign recognition with Map Data, stored speed sign data may influence the indicated speed limit value.

SPEED SIGN RECOGNITION PRECAUTIONS



WARNING: You are responsible for controlling your vehicle at all times. The system is designed to be an aid and does not relieve you of your responsibility to drive with due care and attention. Failure to follow this instruction could result in the loss of control of your vehicle, personal injury or death.



WARNING: In cold and severe weather conditions the system may not function. Rain, snow and spray can all limit sensor performance.



WARNING: The system may not operate properly if the sensor is blocked. Keep the windshield free from obstruction.

Note: Do not carry out windshield repairs in the immediate area surrounding the sensor.

Note: If your vehicle has a suspension kit not approved by Ford, the system may not correctly function.

Note: The system may not detect all speed signs and may incorrectly read signs.

Note: Always fit our original parts when replacing headlamp bulbs. Other bulbs may reduce system performance.

SPEED SIGN RECOGNITION LIMITATIONS

Speed sign recognition may not detect the correct speed due to:

- Construction zones.
- Outdated map data.
- Incorrect recognition of speed limits by the sensor of signs on parallel roads or exit ramps.
- Missed recognition of faded, dirty, or distorted signs.

Note: The system may not detect all speed signs and may incorrectly read signs.

SPEED SIGN RECOGNITION INDICATORS



When the system detects a speed limit sign, it appears in the instrument cluster display.

Speed Sign Recognition (If Equipped)

Note: Sign indicator image may vary based on your vehicle's display type.

SPEED SIGN RECOGNITION SETTINGS

From the driver assistance menu, press Speed Limit Assist. See **Driver Assistance Menu** (page 560).

You can adjust the following settings:

- Switch the speed warning on or off.
- Set the speed limit tolerance (if equipped).



If you see this icon next to a menu option, press it for more information.

SPEED SIGN RECOGNITION – TROUBLESHOOTING

SPEED SIGN RECOGNITION – INFORMATION MESSAGES

Message	Details
Traffic Sign Reduced Performance See Manual	The traffic sign data provided by the Map Data is unavailable due to weak or no signal. Wait for a short period of time for the signal to improve. If the message continues to appear, have the system checked as soon as possible.

Speed Sign Recognition (If Equipped)

SPEED SIGN RECOGNITION – FREQUENTLY ASKED QUESTIONS

Why does the speed limit change without any sign on the road?

- The speed limit changes due to the speed limit data stored in the map data.

Why does speed sign recognition show a wrong speed limit?

- The system shows a wrong speed limit due to incorrect and outdated map data or due to incorrect recognition of the speed limits by the camera.

Driver Alert (If Equipped)

WHAT IS DRIVER ALERT

Driver alert alerts you if it determines that you are becoming drowsy or if your driving deteriorates.

HOW DOES DRIVER ALERT WORK

Driver alert determines your alertness level based on your driving behavior in relation to the lane markings and other factors using the front windshield camera.

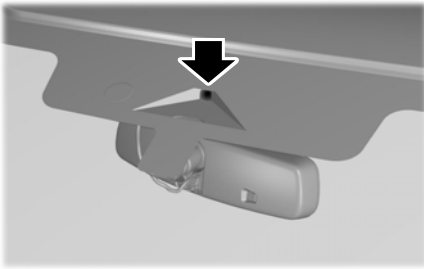

DRIVER ALERT PRECAUTIONS

WARNING: You are responsible for controlling your vehicle at all times. The system is designed to be an aid and does not relieve you of your responsibility to drive with due care and attention. Failure to follow this instruction could result in the loss of control of your vehicle, personal injury or death.

WARNING: Take regular rest breaks if you feel tired. Do not wait for the system to warn you.

WARNING: Certain driving styles may result in the system warning you even if you are not feeling tired.

WARNING: In cold and severe weather conditions the system may not function. Rain, snow and spray can all limit sensor performance.

WARNING: The system will not operate if the sensor cannot track the road lane markings.

WARNING: If damage occurs in the immediate area surrounding the sensor, have your vehicle checked as soon as possible.

WARNING: The system may not correctly operate if your vehicle is fitted with a suspension kit not approved by us.

WARNING: The system may not operate properly if the sensor is blocked. Keep the windshield free from obstruction.

Note: If something is blocking the camera or damaged the windshield, Driver Alert may not function.

DRIVER ALERT LIMITATIONS

Driver alert may not function correctly if:

- The sensor cannot track the road lane markings.
- Your vehicle's speed is less than approximately 65 km/h (40 mph).

Driver Alert (If Equipped)

SWITCHING DRIVER ALERT ON AND OFF

1. From the driver assistance menu, press Driver Alert. See **Driver Assistance Menu** (page 560).
2. Switch the feature on or off.

DRIVER ALERT – TROUBLESHOOTING

DRIVER ALERT – INFORMATION MESSAGES

Message	Action
Driver Alert Warning Rest Now	Stop and rest as soon as it is safe to do so.
Driver Alert Warning Rest Suggested	Take a rest soon.

Load Carrying

LOAD CARRYING PRECAUTIONS

Keep your loaded vehicle weight within its design rating capability, with or without a trailer. Properly loading your vehicle provides maximum return of vehicle design performance. Before you load your vehicle, become familiar with the following terms for determining your vehicle's weight rating, with or without a trailer, from the vehicle's Tire and Loading Information label or Safety Compliance Certification label.



WARNING: Vehicles with a higher center of gravity (utility and four-wheel drive vehicles) handle differently than vehicles with a lower center of gravity (passenger cars). Avoid sharp turns, excessive speed and abrupt steering in these vehicles. Failure to drive cautiously increases the risk of losing control of your vehicle, vehicle rollover, personal injury and death.



WARNING: The appropriate loading capacity of your vehicle can be limited either by volume capacity (how much space is available) or by payload capacity (how much weight the vehicle should carry). Once you have reached the maximum

payload of your vehicle, do not add more cargo, even if there is space available. Overloading or improperly loading your vehicle can contribute to loss of vehicle control and vehicle rollover.



WARNING: Exceeding the Safety Compliance Certification label vehicle weight limits can adversely affect the performance and handling of your vehicle, cause vehicle damage and can result in the loss of control of your vehicle, serious personal injury or death.



WARNING: Do not use replacement tires with lower load carrying capacities than the original tires because they may lower your vehicle's Gross Vehicle Weight Rating and Gross Axle Weight Rating limitations. Replacement tires with a higher limit than the original tires do not increase the Gross Vehicle Weight Rating and Gross Axle Weight Rating limitations.



WARNING: Do not exceed the GVWR or the GAWR specified on the certification label.

Load Carrying

WARNING: Exceeding any vehicle weight rating can adversely affect the performance and handling of your vehicle, cause vehicle damage and can result in the loss of control of your vehicle, serious personal injury or death.

WARNING: When loading the roof racks, we recommend you evenly distribute the load, as well as maintain a low center of gravity. Loaded vehicles, with higher centers of gravity, may handle differently than unloaded vehicles. Take extra precautions, such as slower speeds and increased stopping distance, when driving a heavily loaded vehicle.

Load carrying can also impact other systems present in your vehicle. See **Adaptive Cruise Control Precautions** (page 295). See **Lane Centering Precautions** (page 302).

The gross combined weight must never exceed the Gross Combined Weight Rating.

USING A SLIDE-IN CAMPER

For information regarding the use of slide-in campers, consult the Truck Camper Loading document supplied with your vehicle.

LOCATING THE SAFETY COMPLIANCE CERTIFICATION LABELS

Safety Compliance Certification Label Example:

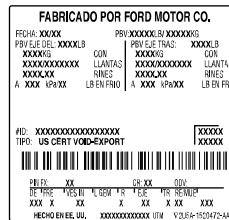
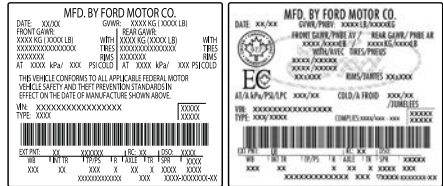

The Safety Compliance Certification label is located on the door pillar, door latch post, or the door edge that meets the door latch post, next to the driver seat.

WHAT IS THE GROSS AXLE WEIGHT RATING

GAWR (Gross Axle Weight Rating)

GAWR is the maximum allowable weight that a single axle (front or rear) can carry. These numbers are on the Safety Compliance Certification label.

Load Carrying

WHAT IS THE GROSS VEHICLE WEIGHT RATING

GVWR is the maximum allowable weight of the fully loaded vehicle. This includes all options, equipment, passengers and cargo. It appears on the Safety Compliance Certification label.

WHAT IS THE GROSS COMBINED WEIGHT RATING

Gross Combined Weight Rating (GCWR) is the maximum allowable weight of the vehicle and the loaded trailer, including all cargo and passengers, that the vehicle can handle without risking damage. (Important: The towing vehicle's braking system is rated for operation at Gross Vehicle Weight Rating, not at Gross Combined Weight Rating.) Separate functional brakes should be used for safe control of towed vehicles and for trailers where the Gross Combined Weight of the towing vehicle plus the trailer exceed the Gross Vehicle Weight Rating of the towing vehicle. See **Recommended Towing Weights** (page 369).

CALCULATING PAYLOAD

Tire and Loading Label Information

Example:



TIRE AND LOADING INFORMATION

SEATING CAPACITY NOMBRE DE PLACES	TOTAL : 5	FRONT: 2	REAR: 3
--------------------------------------	-----------	----------	---------

The combined weight of occupants and cargo should never exceed **385 kg or 850 lbs.**

TIRE	SIZE	COLD TIRE PRESSURE	SEE OWNERS MANUAL FOR ADDITIONAL INFORMATION
FRONT	235/45R18 94V	235 KPA, 34 PSI	
REAR	235/45R18 94V	235 KPA, 34 PSI	
SPARE	NONE	NONE	



TIRE AND LOADING INFORMATION
RENSEIGNEMENTS SUR LES PNEUS ET LE CHARGEMENT

SEATING CAPACITY NOMBRE DE PLACES	TOTAL : 5	FRONT AVANT : 2	REAR ARRIERE : 3
--------------------------------------	-----------	--------------------	---------------------

The combined weight of occupants and cargo should never exceed **396 kg or 875 lbs.**
Le poids total des occupants et du chargement ne doit jamais dépasser **396 kg ou 875 lbs.**

TIRE PNEU	SIZE DIMENSIONS	COLD TIRE PRESSURE PRESSION DES PNEUS A FROID	SEE OWNER'S MANUAL FOR ADDITIONAL INFORMATION VOIR LE MANUEL DE L'USAGER POUR PLUS DE RENSEIGNEMENTS
FRONT AVANT	235/40R19 96V	255 KPA, 37 PSI	
REAR ARRIERE	235/40R19 96V	255 KPA, 37 PSI	
SPARE DE SECOURS	T125/80R16 97M	415 KPA, 60 PSI	

Payload is the combined weight of cargo and passengers that your vehicle is carrying. The maximum payload for your vehicle appears on the Tire and Loading label. The label is either on the B-pillar or the edge of the driver door. Vehicles exported outside the US and Canada may not have a tire and loading label. Look for "The combined weight of occupants and cargo should never exceed XXX kg or XXX lb" for maximum payload. The payload listed on the Tire and Loading Information label

Load Carrying

is the maximum payload for your vehicle as built by the assembly plant. If you install any additional equipment on your vehicle, you must determine the new payload. Subtract the weight of the equipment from the payload listed on the Tire and Loading label. When towing, trailer tongue weight or king pin weight is also part of payload.

CALCULATING THE LOAD LIMIT

Steps for determining the correct load limit:

1. Locate the statement "The combined weight of occupants and cargo should never exceed XXX kg or XXX lb." on your vehicle's placard.
2. Determine the combined weight of the driver and passengers that will be riding in your vehicle.
3. Subtract the combined weight of the driver and passengers from XXX kg or XXX lb.
4. The resulting figure equals the available amount of cargo and luggage load capacity. For example, if the "XXX" amount equals 1,400 lb. and there will be five 150 lb. passengers in your vehicle, the amount of available cargo and luggage load capacity is 650 lb. (1400-750 (5 x 150) = 650 lb.)

5. Determine the combined weight of luggage and cargo being loaded on the vehicle. That weight may not safely exceed the available cargo and luggage load capacity calculated in Step 4.
6. If your vehicle will be towing a trailer, load from your trailer will be transferred to your vehicle. Consult this manual to determine how this reduces the available cargo and luggage load capacity of your vehicle.

Helpful examples for calculating the available amount of cargo and luggage load capacity

Suppose your vehicle has a 1400-pound (635-kilogram) cargo and luggage capacity. You decide to go golfing. Is there enough load capacity to carry you, four of your friends and all the golf bags? You and four friends average 220 pounds (99 kilograms) each and the golf bags weigh approximately 30 pounds (13.5 kilograms) each. The calculation would be: $1400 - (5 \times 220) - (5 \times 30) = 1400 - 1100 - 150 = 150$ pounds. Yes, you have enough load capacity in your vehicle to transport four friends and your golf bags. In metric units, the calculation would be: $635 \text{ kilograms} - (5 \times 99 \text{ kilograms}) - (5 \times 13.5 \text{ kilograms}) = 635 - 495 - 67.5 = 72.5$ kilograms.

Load Carrying

Suppose your vehicle has a 1400-pound (635-kilogram) cargo and luggage capacity. You and one of your friends decide to pick up cement from the local home improvement store to finish that patio you have been planning for the past two years. Measuring the inside of the vehicle with the rear seat folded down, you have room for twelve 100-pound (45-kilogram) bags of cement. Do you have enough load capacity to transport the cement to your home? If you and your friend each weigh 220 pounds (99 kilograms), the calculation would be: $1400 - (2 \times 220) - (12 \times 100) = 1400 - 440 - 1200 = -240$ pounds. No, you do not have enough cargo capacity to carry that much weight. In metric units, the calculation would be: $635 \text{ kilograms} - (2 \times 99 \text{ kilograms}) - (12 \times 45 \text{ kilograms}) = 635 - 198 - 540 = -103$ kilograms. You will need to reduce the load weight by at least 240 pounds (104 kilograms). If you remove three 100-pound (45-kilogram) cement bags, then the load calculation would be: $1400 - (2 \times 220) - (9 \times 100) = 1400 - 440 - 900 = 60$ pounds. Now you have the load capacity to transport the cement and your friend home. In metric units, the calculation would be: $635 \text{ kilograms} - (2 \times 99 \text{ kilograms}) - (9 \times 45 \text{ kilograms}) = 635 - 198 - 405 = 32$ kilograms.

The above calculations also assume that the loads are positioned in your vehicle in a manner that does not overload the front or the rear gross axle weight rating specified for your vehicle on the Safety Compliance Certification label.

Pickup Bed

PICKUP BED PRECAUTIONS

WARNING: Do not allow people or animals in truck beds that have modifications, such as bed covers or slide-in campers, when the engine is running. Exhaust fumes are toxic. Failure to follow this instruction could result in personal injury or death.

WARNING: It is extremely dangerous to ride in a cargo area, inside or outside of a vehicle. In a crash, people riding in these areas are more likely to be seriously injured or killed. Do not allow people to ride in any area of your vehicle that is not equipped with seats and seatbelts. Make sure everyone in your vehicle is in a seat and properly using a seatbelt. Failure to follow this warning could result in serious personal injury or death.

the maximum payload of your vehicle, do not add more cargo, even if there is space available. Overloading or improperly loading your vehicle can contribute to loss of vehicle control and vehicle rollover.

WARNING: Do not use the load retaining fixtures for towing. Failure to follow this instruction could result in personal injury.

WARNING: Do not exceed the maximum load rating of the load retaining fixtures. Failure to follow this instruction could result in personal injury.

WARNING: Check the load retaining fixtures for damage before using them. Failure to follow this instruction could result in personal injury.

PICKUP BED ANCHOR POINTS

(IF EQUIPPED)

PICKUP BED ANCHOR POINT PRECAUTIONS

WARNING: Always properly secure cargo to prevent shifting cargo or cargo falling from the vehicle. Failure to do so could result in compromised vehicle stability and serious personal injury to vehicle occupants or others.

WARNING: The appropriate loading capacity of your vehicle can be limited either by volume capacity (how much space is available) or by payload capacity (how much weight the vehicle should carry). Once you have reached

LOCATING THE PICKUP BED ANCHOR POINTS

The pickup bed anchor points are located at each corner of the pickup bed.



Pickup Bed

PICKUP BED ANCHOR POINT LOAD CAPACITIES

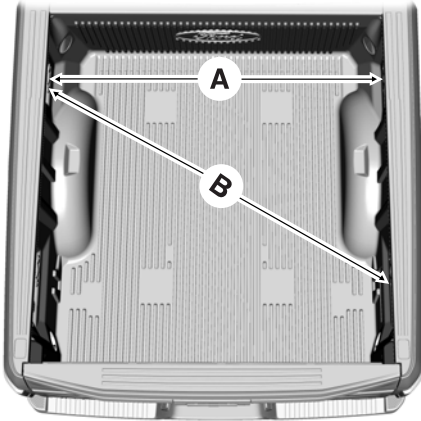

A	B
Maximum force between directly opposed cleats 125 kg (276 lb).	Maximum force between diagonally opposed cleats 272 kg (600 lb).

Note: You could damage the pickup bed walls if you overload the tie downs.

Note: Make sure that you properly balance and secure the cargo load. Failure to do this can cause cargo instability and damage to the box.

Note: Do not secure cargo with tie downs connected from the tie down brackets to the cargo box tie downs. This could cause the tailgate to detach.

TAILGATE ANCHOR POINTS

LOCATING THE TAILGATE ANCHOR POINTS

The tailgate anchor points are located at each side of the tailgate.



Note: You could damage the tailgate if you overload the tie downs.

TAILGATE ANCHOR POINT LOAD CAPACITIES

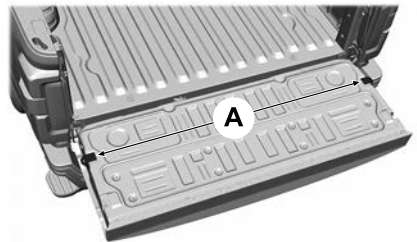

Pickup Bed

A
The maximum force between the tailgate anchor points 181 kg (400 lb).

Note: *Do not secure cargo from a pickup bed anchor point to a tailgate anchor point. This could cause the tailgate to detach.*

PICKUP BED VIDEOS

[Boxlink Video Link](#)

Connecting a Trailer

CONNECTING A TRAILER PRECAUTIONS

Do not tow a trailer until you drive your vehicle at least 1,600 km (1,000 mi).

Consult your local motor vehicle laws for towing a trailer.

See the instructions included with towing accessories for the proper installation and adjustment specifications.

Service your vehicle more frequently if you tow a trailer. See **General Maintenance Information** (page 589).

If you use a rental trailer, follow the instructions the rental agency gives you.

When attaching the trailer wiring connector to your vehicle, only use a proper fitting connector that works with the vehicle and trailer functions.

Account for the trailer coupler weight as part of your vehicle load when calculating the total vehicle weight.

Do not exceed the load limits. See **Calculating the Load Limit** (page 354).

HITCHES

INSTALLING A HITCH



WARNING: You must use the drawbar pin supplied with your vehicle or a pin that is designed to meet the maximum rating of your hitch. Failure to follow this instruction could cause the trailer to disconnect resulting in the loss of control of your vehicle, personal injury or death.

Do not use a hitch that either clamps onto the bumper or attaches to the axle. Distribute the load in your trailer so that 10-15% for conventional towing or 15-25% for fifth wheel towing of the total weight of the trailer is on the tongue. Do not exceed the tongue load rating indicated on the conventional hitch receiver.

Note: *On pickup trucks, the trailer hitch provided on the vehicle enhances crash protection for the fuel system. Do not remove.*

Hitch Components

The following components are required. Some are provided in certain vehicles.

- A trailer hitch with a 3 inch receiver and a 5/8 inch hitch pin. Check the stamped rating number on the pin to determine the 13,607 kg (30,000 lb) hitch pin capacity.
- A hitch pin sleeve stored in the glove compartment to use when mounting the 3 inch drawbar with the 3/4 inch pinhole.
- A cotter pin to help keep the hitch pin in place.

Connecting a Trailer

Installing a 3 Inch Drawbar with 3/4 Inch Pin Hole

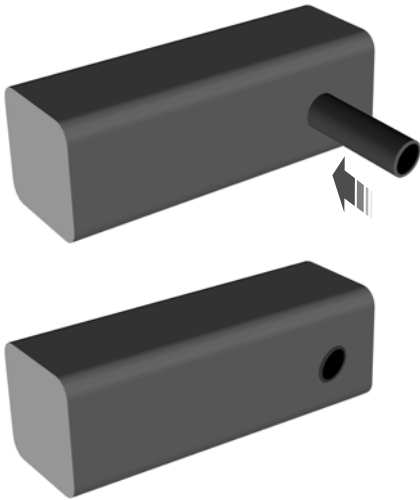

Insert the pin sleeve in the 3/4 inch pinhole of the 3 inch drawbar.

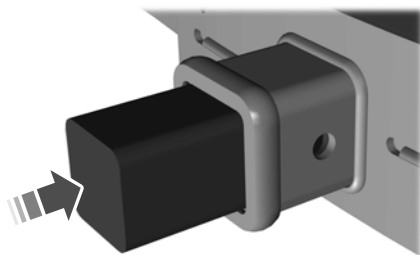

Remove the reducers before inserting the 3 inch drawbar. Insert the drawbar into the hitch receiver.

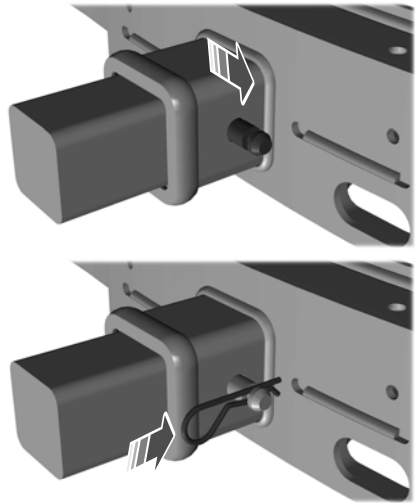

Put the 5/8 inch hitch pin through the pinhole. Place the cotter pin around the neck of the hitch pin.

HOOKING UP A TRAILER USING A WEIGHT-DISTRIBUTING HITCH



WARNING: Do not adjust the spring bars so that your vehicle's rear bumper is higher than before attaching the trailer. Doing so will defeat the function of the weight-distributing hitch, which may cause unpredictable handling, and could result in serious personal injury.

A weight-distributing hitch helps distribute tongue load to all towing vehicle and trailer wheels. For more information, visit the links in the following table.

Connecting a Trailer

Market	Website
United States of America	https://www.fordpro.com/en-us/fleet-vehicles/manuals-and-guides/
Canada (English)	https://www.fordpro.ca/en-ca/fleet-vehicles/manuals-and-guides/
Canada (French)	https://www.fordpro.ca/fr-ca/fleet-vehicles/manuals-and-guides/

Connecting a Trailer

FIFTH-WHEEL TRAILER HITCH (If Equipped)

Your vehicle has a fifth-wheel prep package. This package enables your vehicle to accept certain fifth-wheel trailer hitches and gooseneck ball hitches. The fifth-wheel trailer hitch attaches to the four mounting pads in the pick-up bed. A 7-pin trailer wiring connector could be in the bed as well. The gooseneck ball hitch is a separate mounting pad from the fifth-wheel hitch in the center of the bed.

Shorter pick-up boxes provide less clearance between the cab and the fifth-wheel and gooseneck trailer compared to longer box pick-ups. When selecting a trailer and tow vehicle, it is critical to check that this combination provides clearance between the front of the trailer and tow vehicle for turns up to 90°. Failure to follow this recommendation could result in the trailer contacting the cab of the tow vehicle during tight turns that are typical during low-speed parking and turning maneuvers. This contact could result in damage to the trailer and tow vehicle.

Note: Contact an authorized dealer to purchase gooseneck and fifth-wheel hitches that are compatible with your vehicle.

Note: The mounting pads in the bed are specifically designed for certain fifth-wheel trailer hitches and gooseneck ball hitches. Do not use these mounting pads for other purposes.

CONNECTING A TRAILER

Recognizing a Trailer

1. Attach the trailer and wiring connector to your vehicle.
2. Switch on your vehicle.

3. Set up a profile for the trailer using the SYNC screen.

Note: If your vehicle does not recognize the trailer, press and hold the brake pedal for a few seconds.

Note: Trailer profiles store trailer types, dimensions, preferences, trailer specific mileage and fuel economy.

Note: Disabling the trailer detection notification makes the default trailer profile active when a connection is detected.

Note: Trailer profiles allows you to setup several trailer maintenance reminders and maintenance intervals for multiple trailer components by specifying miles and months in service.

Note: Trailer maintenance reminder is designed to be an aid and does not relieve you of your responsibility to follow the trailer manufacturers recommended maintenance intervals. You are responsible for inputting maintenance intervals consistent with the trailer manufacturer.



When attaching the trailer wiring connector to your vehicle, only use a proper fitting connector that works with the vehicle and trailer functions.

Connecting a Trailer

Safety Chains

Install trailer safety chains to the trailer hitch as recommended by the manufacturer. Cross the chains under the trailer coupler and allow enough slack for turning tight corners. Do not allow the chains to drag on the ground.

Note: Do not attach safety chains to the bumper. Always connect the safety chains to the frame or hook retainers of your trailer hitch.

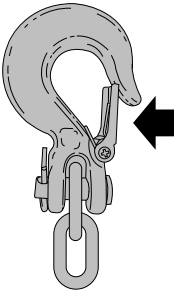

If the trailer safety chain hook has a latch, make sure to fully close the latch.

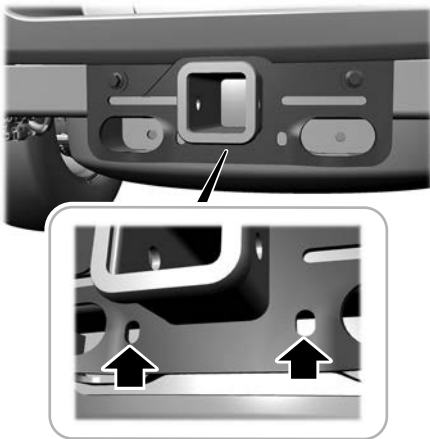

Use the smaller holes in the safety chain bracket for trailer breakaway cables and small 3/8" s-hooks.

TRAILER BATTERY CHARGE/ TRAILER POWER FEED

This feature allows the trailer's battery to charge under the following situations:

- Your vehicle is in the accessory or engine run position
- If the vehicle's battery voltage is in optimum condition, above 12.5 volts, and the trailer's battery can still hold a charge, or is not too old.

The trailer power feed feature allows for a 12 volt power output on a 7-pin connector when the system detects a trailer.

Note: Trailer power feed can provide a maximum output rate of 15 amps.

Note: Never place more demand than 15 amps of power on the trailer power feed, this may damage the trailer lighting.

TRAILER LIGHTING CHECK

WARNING: Never connect any trailer lamp wiring to the vehicle's tail lamp wiring; this may damage the electrical system resulting in fire. Contact your authorized dealer as soon as possible for assistance in proper trailer tow wiring installation. Additional electrical equipment may be required.

Trailer light check feature allows one person to confirm that all taillights are functioning.

Perform a trailer light illumination sequence to confirm that all lights are functioning using the SYNC screen in the vehicle or the Ford mobile app.

Connecting a Trailer

Performing the Trailer Light Check using the SYNC screen in vehicle

1. Press **Features** on the touchscreen.
2. Press **Towing**.
3. Press **Trailer Light Check**.
4. Press **Start**.
5. Follow the instructions until the lights sequence completes.

Performing the Trailer Light Check using the Ford mobile app

1. Create or sign-in to the Ford mobile app and add the vehicle identification number to your account.

2. Once you add the vehicle identification number, follow the prompts in the Ford mobile app to complete the Sync Connect Authorization process.
3. After the authorization is complete, navigate to Vehicle Details screen and select Trailer Light Check.
4. Press **Start**.
5. Follow the instructions until the lights sequence completes.

Note: *Trailer light check feature is available only in vehicles with trailer capability and trailer must be electrically connected for feature to function.*

Connecting a Trailer

CONNECTING A TRAILER – TROUBLESHOOTING

CONNECTING A TRAILER – INFORMATION MESSAGES

Message	Description
Trailer Disconnected	The system senses a trailer connection becomes disconnected, either intentionally or unintentionally, during a given ignition cycle.
Trailer Wiring Fault	There are certain faults in your vehicle wiring and trailer wiring or brake system.
Trailer Lighting Module Fault See Manual	The system detects a short induced by the trailer wiring. Inspect and repair the trailer wiring or see your authorized dealer.
Trailer Battery Not Charging See Manual	The vehicle's battery voltage is low or there is a fault with your trailer's battery. Your trailer's battery voltage is below 8 volts or it is connected in reverse polarity.
Trailer Tire Low Specified:	One or more tires on your trailer is below the specified tire pressure.
Trailer Tire Over Temperature	Displays when one or more tires on the trailer is above the recommended temperature.
Trailer Tire Pressure Sensor Fault	A trailer tire pressure sensor is malfunctioning. If the warning stays on or continues to come on, have the system checked as soon as possible.
Trailer Tire Pressure Monitor Fault	The trailer tire pressure monitoring system is malfunctioning. If the warning stays on or continues to come on, have the system checked.
Trailer Tire Pressure Monitor Capability Not Detected	The system cannot detect the trailer tire pressure monitoring system.
Trailer Tire Pressure Indication Not Setup See Manual	The trailer tire pressure monitoring system is not set up.

Towing a Trailer

TOWING A TRAILER PRECAUTIONS

 **WARNING:** Do not exceed the GVWR or the GAWR specified on the certification label.

 **WARNING:** Towing trailers beyond the maximum recommended gross trailer weight exceeds the limit of your vehicle and could result in engine damage, transmission damage, structural damage, loss of vehicle control, vehicle rollover and personal injury.

 **WARNING:** Do not exceed the lowest rating capacity for your vehicle or trailer hitch. Overloading your vehicle or trailer hitch can impair your vehicle stability and handling. Failure to follow this instruction could result in the loss of control of your vehicle, personal injury or death.

 **WARNING:** Make sure that the vertical load on the tow ball is between the minimum and maximum recommended weight at all times. Failure to follow this instruction could result in the loss of control of your vehicle, personal injury or death.

 **WARNING:** Do not cut, drill, weld or modify the trailer hitch. Modifying the trailer hitch could reduce the hitch rating.

 **WARNING:** The anti-lock brake system does not control the trailer brakes.

TRAILER BRAKE PRECAUTIONS

 **WARNING:** Do not connect a trailer's hydraulic brake system directly to your vehicle's brake system. Your vehicle may not have enough braking power and your chances of having a collision greatly increase.

 **WARNING:** Do not tow a trailer fitted with electric trailer brakes unless your vehicle is fitted with a compatible aftermarket electronic trailer brake controller. Failure to follow this instruction could result in the loss of control of your vehicle, personal injury or death. For additional information and assistance, we recommend that you contact an authorized dealer.

Electric brakes and manual, automatic or surge-type trailer brakes are safe if you install them properly and adjust them to the manufacturer's specifications. The trailer brakes must meet local and federal regulations.

The rating for the tow vehicle's braking system operation is at the gross vehicle weight rating, not the gross combined weight rating.

Towing a Trailer

Certain states require functioning trailer brakes for trailers over a specified weight. Be sure to check state regulations for this specified weight.

Ford Motor Company recommends separate functioning brake systems for trailers weighing more than 680 kg (1,500 lb) when loaded.

TOWING A TRAILER LIMITATIONS

The vehicle's load capacity designation is by weight, not by volume, so you cannot necessarily use all available space when loading a vehicle or trailer.

Towing a trailer also depends on additional systems present in your vehicle. See **Lane Keeping System Precautions** (page 316). See **Adaptive Cruise Control Precautions** (page 295).

Note: *Your vehicle could have reduced performance when operating at high altitudes and when heavily loaded or towing a trailer. When driving at elevation, to match driving performance as perceived at sea level, reduce gross vehicle weight and gross combination weight by 2% per 300 m (1,000 ft) elevation.*

LOADING YOUR TRAILER

To help minimize how trailer movement affects your vehicle when driving:

- Load the heaviest items closest to the trailer floor.
- Load the heaviest items centered between the left-hand and right-hand side trailer tires.
- Load the heaviest items above the trailer axles or just slightly forward toward the trailer tongue. Do not allow the final trailer tongue weight to go above or below 10-15% of the loaded trailer weight. The trailer tongue weight should never exceed 10% of the maximum towing capacity when towing a conventional trailer, and should never exceed 15% of the maximum towing capacity when towing a fifth-wheel or gooseneck trailer.
- Select a ball mount with the correct rise or drop. When you connect both the loaded vehicle and trailer, the trailer frame should be level, or slightly angled down toward your vehicle, when viewed from the side.

Towing a Trailer

TRAILER TOWING HINTS

Towing a trailer places an extra load on your vehicle's engine, transmission, axle, brakes, tires and suspension. Periodically inspect these components during and after any towing operation.

When driving with a trailer or payload, a slight takeoff vibration or shudder may be present due to the increased payload weight.

Your vehicle may have a temporary or conventional spare tire. A temporary spare tire is different in diameter or width, tread-type, or is from a different manufacturer than the road tires on your vehicle. Consult information on the tire label or Safety Compliance label for limitations when using.

When towing a trailer:

- Obey country specific regulations for towing a trailer.
- Do not tow during the first 1,609 km (1,000 mi), the driveline requires a break-in during that time. See **Breaking-In** (page 418).
- Do not make full-throttle starts.
- Check your hitch, electrical connections and trailer wheel lug nuts thoroughly after you have traveled 80 km (50 mi).
- When stopped in congested or heavy traffic during hot weather, place the transmission in park (P) to aid engine and transmission cooling and to help A/C performance.
- Turn off the speed control with heavy loads or in hilly terrain. The speed control may turn off when you are towing on long, steep slopes.
- Shift to a lower gear when driving down a long or steep hill. Do not continuously apply the brakes, as they may overheat and become less effective.

- If your transmission has Grade Assist or Tow/Haul, use this feature when towing. This provides engine braking and helps eliminate excessive transmission shifting for optimum fuel economy and transmission cooling.
- If your vehicle has AdvanceTrac with roll stability control, this system may turn on during typical cornering maneuvers with a heavily loaded trailer. This is normal. Turning the corner at a slower speed when towing may reduce this tendency.
- Allow more distance for stopping with a trailer attached. Anticipate stops and gradually brake.
- Avoid parking on a slope. However, if you must park on a slope, turn the steering wheel to point your vehicle tires away from traffic flow, set the parking brake, place the transmission in park (P) and place wheel chocks in front and back of the trailer wheels.

Note: *Chocks are not included with your vehicle.*

LAUNCHING OR RETRIEVING A BOAT OR PERSONAL WATERCRAFT

When backing down a ramp during boat launching or retrieval:

- Do not allow the static water level to rise above the bottom edge of the rear bumper.
- Do not allow waves to break higher than 15 cm (6 in) above the bottom edge of the rear bumper.

Exceeding 15 cm (6 in) could allow water to enter vehicle components, causing internal damage to the components and affecting driveability, emissions and reliability.

Towing a Trailer

Note: Replace the rear axle lubricant anytime the rear axle has been submerged in water.

Note: Disconnect the trailer wiring connector before backing the trailer into the water.

Note: Reconnect the trailer wiring connector after removing the trailer from the water.

TOWING WEIGHTS AND DIMENSIONS

RECOMMENDED TOWING WEIGHTS

Market	Website
United States of America	https://www.fordpro.com/en-us/fleet-vehicles/manuals-and-guides/
Canada (English)	https://www.fordpro.ca/en-ca/fleet-vehicles/manuals-and-guides/
Canada (French)	https://www.fordpro.ca/fr-ca/fleet-vehicles/manuals-and-guides/

Towing a Trailer

WHAT IS THE MAXIMUM LOADED TRAILER WEIGHT

The maximum loaded trailer weight is the highest possible weight of a fully loaded trailer the vehicle can tow.

CALCULATING THE MAXIMUM LOADED TRAILER WEIGHT FOR YOUR VEHICLE

1. Start with the gross combined weight rating for your vehicle model and axle ratio.
2. Subtract all of the following that apply to your vehicle:
 - Vehicle curb weight.
 - Hitch hardware weight, for example a draw bar, ball, locks or weight distributing hardware.

- Driver weight.
- Passenger weight.
- Payload, cargo and luggage weight.
- Aftermarket equipment weight.

This equals the maximum loaded trailer weight for this combination.

Note: *The trailer tongue load is considered part of the payload for your vehicle. Reduce the total payload by the final trailer tongue weight.*

Note: *Consult an authorized dealer to determine the maximum trailer weight allowed for your vehicle if you are not sure.*

Towing a Trailer

TOWING A TRAILER – TROUBLESHOOTING

TOWING A TRAILER – INFORMATION MESSAGES

Message	Details
Trailer Left Turn Lamps Fault Check Lamps	The left-hand trailer turn lamp requires service.
Trailer Right Turn Lamps Fault Check Lamps	The right-hand trailer turn lamp requires service.
Trailer Battery Not Charging See Manual	The vehicle's battery voltage is low or there is a fault with your trailer's battery. Your trailer's battery voltage is below 8 volts or it is connected in reverse polarity.
Trailer Lighting Module Fault See Manual	The system detects a short created by the trailer lamps. Inspect and repair the trailer wiring, or have the system checked as soon as possible.
Trailer Stop Lamps Fault Check Lamps	The trailer stoplamps require service.
Trailer Sway Reduce Speed	The trailer sway control detects trailer sway. Reduce the vehicle's speed.
Trailer Tire Over Temperature	Displays when one or more tires on the trailer is above the recommended temperature.
Trailer Tire Low Specified:	One or more tires on your trailer is below the specified tire pressure.
Trailer Tire Pressure Sensor Fault	A trailer tire pressure sensor requires service. If the warning stays on or continues to come on, have the system checked as soon as possible.
Trailer Tire Pressure Monitor Fault	The trailer tire pressure monitoring system requires service. If the warning stays on or continues to come on, have the system checked as soon as possible.
Trailer Tire Pressure Monitor Capability Not Detected	The system cannot detect the trailer tire pressure monitoring system.
Trailer Tire Pressure Indication Not Setup See Manual	The trailer tire pressure monitoring system is not setup.

Towing a Trailer

Message	Details
Trailer Brake Module Fault	Perform a trailer brake and trailer light check if possible. If the message persists, have your vehicle checked as soon as possible.
Trailer brake system fault See manual	Verify the trailer brake connections are secure and that the aftermarket trailer brake controller device is correctly installed. Perform a trailer brake and trailer light check if possible. If the message persists, have your vehicle checked as soon as possible.

TOWING A TRAILER VIDEOS

[Towing Overview Video Link](#)

Integrated Trailer Brake Controller (If Equipped)

WHAT IS THE INTEGRATED TRAILER BRAKE CONTROLLER

The trailer brake controller assists in smooth and effective trailer braking based on the towing vehicle's brake pressure.

INTEGRATED TRAILER BRAKE CONTROLLER PRECAUTIONS



WARNING: Use the integrated trailer brake controller to properly adjust the trailer brakes and check all connections before towing a trailer. Failure to follow this instruction could result in the loss of control of your vehicle, personal injury or death.

- Only use the manual control lever for proper adjustment of the gain during trailer setup. Misuse, such as application during trailer sway, could cause instability of trailer or tow vehicle.
- Avoid towing in adverse weather conditions. The trailer brake controller does not provide anti-lock control of the trailer wheels. Trailer wheels can lock up on slippery surfaces, resulting in reduced stability of trailer and tow vehicle.
- The trailer brake controller is only a factory-installed or dealer-installed item. Ford is not responsible for warranty or performance of the controller due to misuse or customer installation.

Note: Do not attempt removal of the trailer brake controller without consulting the *Workshop Manual*. Damage to the unit may result.

Note: Make sure to set the integrated trailer brake controller gain to 0 if you are using an aftermarket trailer brake controller.

USING THE INTEGRATED TRAILER BRAKE CONTROLLER

1. Make sure the trailer brakes are in good working condition, functioning normally and properly adjusted. See your trailer dealer if necessary.

Note: An authorized dealer can diagnose the trailer brake controller to determine exactly which trailer fault has occurred. Your vehicle warranty does not cover issues with your trailer.

2. Hook up the trailer and make the electrical connections according to the trailer manufacturer's instructions.

Note: Select default mode if the trailer has surge brakes, or no brakes at all. The system has no effect on the braking performance of the trailer in either of these cases.

Note: The system does not support the trailer braking function if it is connected by a four-pin connector.

3. When you plug in a trailer with electric or electric-over-hydraulic brakes, a message confirming connection appears in the information display.
4. Use the gain adjustment to find the desired starting point. A gain setting of 6.0 is a good starting point for heavier loads.

Note: Use the following steps to adjust the gain setting whenever road, weather and trailer, or vehicle loading conditions change from when you initially set the gain.

5. In a traffic-free environment, tow the trailer on a dry, level surface and completely squeeze the manual control lever.

Integrated Trailer Brake Controller (If Equipped)

- If the trailer wheels lock up, indicated by squealing tires, reduce the gain setting. If the trailer wheels turn freely, increase the gain setting. Repeat Steps 5 and 6 until the gain setting is at a point just below trailer wheel lock-up. If towing a heavier trailer, trailer wheel lock-up may not be attainable even with the maximum gain setting of 10.

Note: Only perform this procedure at speeds of approximately 30–40 km/h (20–25 mph).

Note: The trailer brake controller reduces output at vehicle speeds below 18 km/h (11 mph) so that trailer and vehicle braking is not jerky or harsh. This feature is only available when applying the brakes using your vehicle's brake pedal, not the controller.

Note: Your vehicle's brake system and the trailer brake system work independently of each other. Changing the gain setting on the controller does not affect the operation of your vehicle's brakes whether you attach a trailer or not.

Note: With the proper electrical connection, pressing your vehicle's brake pedal or using the manual control lever illuminates both trailer and vehicle brake lamps.

Note: When you switch the engine off, the controller output disables and the display and module shut down. The controller module and display turn on when you switch the ignition on.

Note: The system suspends stop/start when you attach a trailer with electric or electric over hydraulic brakes to your vehicle.

Adjusting the Trailer Brake Gain

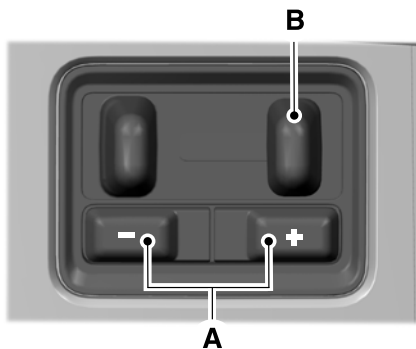

- Use the gain adjustment (+) and (-) buttons to increase or decrease the gain setting to the desired starting point. The trailer brake controller allows adjustment of brake gain from 0% to 100% in 5% increments.
- Use the manual slider to directly apply trailer braking.

Note: Adjust the gain setting before using the trailer brake controller for the first time.

Note: Set the gain to provide the maximum trailer braking assistance while making sure the trailer wheels do not lock when using the brakes. Locked trailer wheels may lead to trailer instability.

Note: The system saves the setting adjustments when you select a trailer profile.

Note: If you have installed an aftermarket trailer brake controller in addition to the integrated trailer brake controller, set the gain on the integrated trailer brake controller to zero.

Integrated Trailer Brake Controller (If Equipped)

ADJUSTING THE INTEGRATED TRAILER BRAKE CONTROLLER MODE

Select the correct integrated trailer brake controller mode option using the touchscreen.

Note: Trailer brake gain settings are saved to the active trailer profile.

Selecting the Trailer Brake Type

1. Press **Default** for trailers with electromagnetic drum brake systems or press **Electric over Hydraulic** for trailers with electrically actuated hydraulic brake systems.

2. Press **Save**.

Selecting the Trailer Brake Effort

1. Select a setting for your trailer.

Note: The default value is **Low** and is the recommended setting for most trailers. Select a different setting if your trailer's brakes require more initial voltage, or you prefer more aggressive trailer braking.

2. Press **Save**.

Integrated Trailer Brake Controller (If Equipped)

INTEGRATED TRAILER BRAKE CONTROLLER – TROUBLESHOOTING

INTEGRATED TRAILER BRAKE CONTROLLER – INFORMATION MESSAGES

Message	Details
Trailer Connected	The system detects a correct trailer connection during a given ignition cycle.
Trailer Disconnected	The system detects the trailer wiring connection is disconnected during a given ignition cycle.
Trailer Wiring Fault	The system detects an electrical fault in the trailer brake circuit. If this message appears without a trailer attached, see your authorized dealer. If a trailer is attached, inspect and repair the trailer wiring.
Trailer Brake Gain: {trailer gain value:#0.0}	Displays the current gain setting for the trailer brake.
Trailer Brake Gain: {trailer gain value:#0.0} No Trailer	Displays the current gain setting for the trailer brake when you do not have a trailer connected.
Trailer Battery Not Charging See Manual	The vehicle's battery voltage is low or there is a fault with your trailer's battery. Your trailer's battery voltage is below 8 volts or it is connected in reverse polarity.
Trailer Brake Module Fault	Perform a trailer brake and trailer light check if possible. If the message persists, have your vehicle checked as soon as possible.
Trailer brake system fault See manual	Verify the trailer brake connections are secure and that the aftermarket trailer brake controller device is correctly installed. Perform a trailer brake and trailer light check if possible. If the message persists, have your vehicle checked as soon as possible.

Integrated Trailer Brake Controller (If Equipped)

INTEGRATED TRAILER BRAKE CONTROLLER – FREQUENTLY ASKED QUESTIONS

How do I determine if there is an issue with the wiring on my vehicle?

- A message displays accompanied by a single tone, when no trailer is connected. This indicates that the issue is between the trailer brake controller and the 7-pin connector at the bumper.

How do I determine if there is an issue with the wiring on my trailer?

- A message only displays with a trailer connected. Consult your trailer dealer for assistance.

Trailer Sway Control

HOW DOES TRAILER SWAY CONTROL WORK

The system applies the brakes to the individual wheels and reduces engine torque to aid vehicle stability.

If the trailer begins to sway, the stability control lamp flashes and the message **Trailer Sway Reduce Speed** appears in the information display.

Stop your vehicle as soon as it is safe to do so. Check the vertical weight on the tow ball and trailer load distribution.

2. Press **Towing**.
3. Switch **Trailer Sway Control** on or off.

The system turns on each time you start your vehicle.

TRAILER SWAY CONTROL PRECAUTIONS



WARNING: Turning off trailer sway control increases the risk of loss of vehicle control, serious injury or death. Ford does not recommend disabling this feature except in situations where speed reduction may be detrimental (such as hill climbing), the driver has significant trailer towing experience, and can control trailer sway and maintain safe operation.

Note: *This feature only activates when significant trailer sway occurs.*

Note: *This feature does not prevent trailer sway, but reduces it once it begins.*

Note: *This feature cannot stop all trailers from swaying.*

Note: *In some cases, if vehicle speed is too high, the system may activate multiple times, gradually reducing vehicle speed.*

SWITCHING TRAILER SWAY CONTROL ON AND OFF

1. Press **Features** on the touchscreen.

Trailer Hitching Assistance (If Equipped)

WHAT IS TRAILER HITCHING ASSISTANCE

Trailer hitching assistance helps the driver align the vehicle hitch ball to a trailer coupler.

HOW DOES TRAILER HITCHING ASSISTANCE WORK

Trailer hitching assistance uses the following to detect your trailer:

- Rear view camera.
- Radar.
- Parking aid sensors.
- External rear lighting.

This feature also controls the following to align the hitch ball with the trailer coupler:

- Steering.
- Braking and acceleration.

Note: Blocked sensors could affect system performance. Do not cover the sensors with bumper stickers, tape, repair compound or other objects.

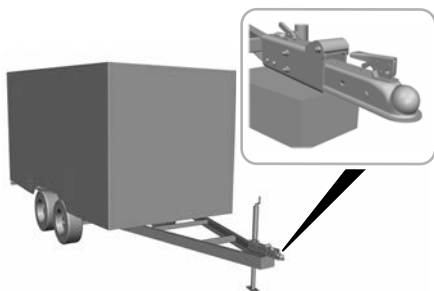

TRAILER HITCHING ASSISTANCE PRECAUTIONS

WARNING: You are responsible for controlling your vehicle at all times. The system is designed to be an aid and does not relieve you of your responsibility to drive with due care and attention. Failure to follow this instruction could result in the loss of control of your vehicle, personal injury or death.

WARNING: The system is not designed to detect cyclists, motorcyclists, pedestrians or animals. Apply the brakes when necessary. Failure to follow this instruction could result in personal injury or death.

WARNING: The system may not operate properly during severe weather conditions, for example snow, ice, heavy rain and spray. Always drive with due care and attention. Failure to take care may result in a crash.

Note: Fifth wheel and gooseneck trailers are not supported.

Note: Trailer hitching assistance only works with conventional trailers, couplers and hitch balls.

Note: The hitch ball must be properly installed on the vehicle for the system to function as intended. An improperly installed hitch ball could result in damage to your vehicle or trailer.

Note: Certain aftermarket modifications such as oversized tires or lift kits could make trailer hitching assistance fail or not work as intended.

Note: Keep the sensors and camera free from snow, ice and dirt.

Note: Clean the camera lens with a soft, lint-free cloth and non-abrasive cleaner.

Trailer Hitching Assistance (If Equipped)

TRAILER HITCHING ASSISTANCE LIMITATIONS

The system could not function, or could function with reduced performance, during the following:

- When using trailer hitching assistance in tall grass and weeds.
- When safety chains, cables or wiring are dangling near the coupler.
- When using trailer hitching assistance on slippery surfaces.
- When using hitches that raise the hitch ball more than 10 cm (4 in), lower the hitch ball by more than 16 cm (6 in) or extend the hitch ball away from the vehicle more than 30 cm (12 in).
- When using hitches that are lower than 25 cm (10 in) off the ground.
- When using objects taller than 20 cm (8 in), such as large blocks under the jack stand.
- When you park the trailer on surfaces that are similar in color to the trailer coupler and hitch ball.
 - A black coupler or hitch ball over a dark asphalt surface.
 - A light color coupler or hitch ball over a light concrete surface.
- When there are low or no light sources, such as at night.
- The feature may not align accurately during cold weather. If this occurs, allowing the engine to reach normal operating temperature may improve performance.

For additional information, refer to the Ford Support website.

SWITCHING TRAILER HITCHING ASSISTANCE ON AND OFF



Press the button to switch the system on and off. You can also switch the system off through the touchscreen.

USING TRAILER HITCHING ASSISTANCE

Before switching on the system, make sure that your vehicle:

- Is within 6 m (20 ft) of the trailer and no closer than 2 m (7 ft).
- Is less than a 30° approach angle to the trailer.
- Is within 1 m (3 ft) of the front of the trailer facing the same direction.

Trailer Hitching Assistance (If Equipped)

- Is clear of obstacles or other vehicles within 1.8 m (6 ft) on either side of your vehicle or the trailer.
- Has the tailgate in the closed position.
- Has radar, sensor, and camera free from snow, ice and dirt.
- Has parking aid sensors switched on in the touchscreen.

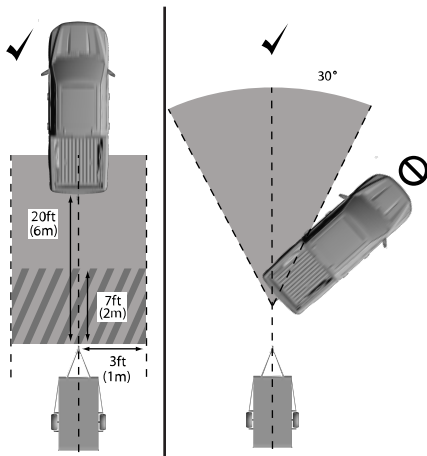

1. Press the Pro Trailer button.

Note: Press the Pro Trailer button to switch the system on and off.

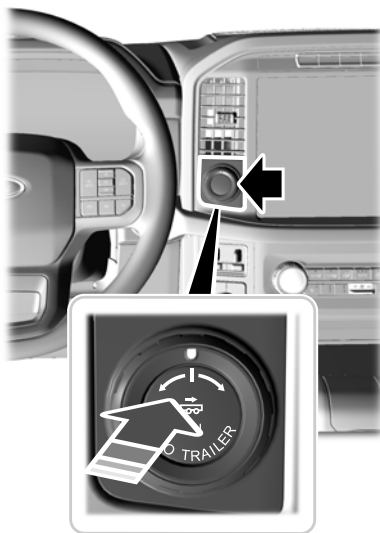

2. When asked if a trailer is connected, select no on the touchscreen to activate the system.
3. Follow the instructions on the touchscreen.

Note: Pressing the Pro Trailer button other than when prompted turns off the system.

TRAILER HITCHING ASSISTANCE INDICATORS



The white indicator represents the system searching for the trailer. Continue moving the vehicle until the trailer coupler is inside this indicator. The indicator turns green once the trailer coupler is in the correct position.



The bracket shows you the estimated location of your trailer.

Trailer Hitching Assistance (If Equipped)



The yellow indicator represents that you have positioned your vehicle too close to the trailer and you need to pull away from the trailer until the indicator turns green.

Trailer Hitching Assistance Audible Indicators

A tone sounds as part of normal operation of the system to alert the driver that an action needs to be taken or an event has been completed.

Trailer Hitching Assistance (If Equipped)

TRAILER HITCHING ASSISTANCE – TROUBLESHOOTING

TRAILER HITCHING ASSISTANCE – INFORMATION MESSAGES

Message	Details
Pro Trailer Hitch Assist Not Available Low Light Detected	Displays when your vehicle's light sensor located in the center of the front dashboard is detecting a low light condition. The feature functions only in adequate daylight conditions and it is not designed to operate in low light. Make sure there are no items covering the light sensor.
Pro Trailer Hitch Assist Not Available Refer to Owner's Manual	This message may indicate that your vehicle's camera or steering system requires additional initialization to support this feature. Drive your vehicle straight forward for a few minutes. Then, turn the vehicle off for 5 minutes. Turn it back on to see if the issue is resolved. Due to environmental conditions, some vehicles may take multiple attempts or a longer driving duration to complete the camera or steering system initialization. If the message continues to be displayed, visit your authorized dealer to have your vehicle checked.
Pro Trailer Hitch Assist Canceled System Error	Turn the vehicle off and back on again. Wait 30 seconds before activating the Pro Trailer Hitch Assist feature. If the message continues to be displayed, visit your authorized dealer to have your vehicle checked.
Pro Trailer Hitch Assist Canceled Shift to P	Displays when a condition exists that prevents the system from completing the alignment. Make sure all the items in the USING TRAILER HITCHING ASSISTANCE section are in place. If the message continues to be displayed, visit your authorized dealer to have your vehicle checked.

Trailer Hitching Assistance (If Equipped)

Message	Details
Pro Trailer Hitch Assist Canceled Trailer Detection Lost	<ul style="list-style-type: none"> • Check for objects, water, dirt, or ice covering the rear view camera. • Reposition vehicle within the allowable limit as shown in the USING TRAILER HITCHING ASSISTANCE section. • Check for a person, pet, or object in the path between the hitch ball and the trailer coupler. The Pro Trailer Hitch Assist feature monitors the area between the vehicle and trailer. • Make sure the trailer coupler has adequate lighting with minimal shadow and enough contrast from its surroundings for the camera to detect it. The system may not detect your trailer if it cannot distinguish the trailer coupler from the background.
Pro Trailer Hitch Assist Canceled Object Detected In Path	<ul style="list-style-type: none"> • Check for objects, water, dirt, or ice covering the rear parking aid sensors. • Clear any objects from behind the vehicle or wheels. • Avoid using the system on rough terrain. • Make sure the parking aid sensors are switched ON in the touchscreen. See Switching Parking Aid On and Off (page 280). See Switching Parking Aid On and Off (page 281).

Note: If the system consistently stops too close to the trailer, lowering the trailer coupler to be closer to the minimum of 1.27 cm (0.50 in) higher than the hitch ball may improve the alignment.

Note: If the system consistently stops too far from the trailer, raising the trailer coupler to be closer to the maximum of 7.62 cm (3.00 in) higher than the hitch ball may improve the alignment.

Note: Any changes or modifications to the vehicle could affect the functionality and performance of the system or prevent it from working.

Smart Hitch (If Equipped)

WHAT IS SMART HITCH

Smart hitch shows an estimate of trailer weight that is on the vehicle's hitch.

HOW DOES SMART HITCH WORK

Smart hitch uses sensors mounted to the suspension to calculate the estimated hitch weight of the connected trailer.

SMART HITCH LIMITATIONS

You cannot use the system if any of the following occur:

- The wheels are not pointed straight ahead.
- Your vehicle is not in park (P) or your vehicle speed is over 8 km/h (5 mph).
- Your vehicle is not on a level surface.
- The tire pressures are below the recommended levels.
- Your vehicle is off.

USING SMART HITCH

From the features menu, press Smart Hitch. See **Center Display** (page 558).

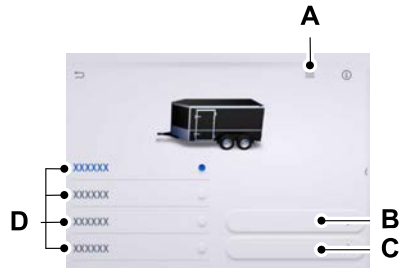

- A Settings menu.
- B Quick setup.
- C Connection checklist.
- D Hitch type selection.

Smart Hitch Settings

Press the settings menu to adjust the smart hitch settings.

Measurement Units

Press to change measurement units between pounds and kilograms.

Quick Setup

Press to skip the trailer setup guide and follow steps to display estimated hitch weight percentage and recommended adjustments.

Connection Checklist

Press to go through the trailer setup guide and follow steps to display estimated hitch weight percentage and recommended adjustments.

Reset Hitch Weight

Press to reset the weight on the hitch to zero.

Smart Hitch (If Equipped)

Loaded Trailer Weight

Press to set the total weight of the loaded trailer.

Note: *Make sure you include both the trailer weight and the trailer cargo in your calculation for total weight of the loaded trailer.*

Tail Lamps

Press to see the estimated hitch weight percentage on the vehicle's tail lamps.

Hitch Type Selection

Press to select the hitch type.

Note: *The vehicle's tongue weight is not available until you attach a trailer.*

Onboard Scales (If Equipped)

WHAT IS ONBOARD SCALES

Onboard scales provides the estimated payload of your vehicle and warns when your vehicle may be overloaded.

HOW DOES ONBOARD SCALES WORK

Onboard scales uses sensors mounted to the suspension to calculate the estimated vehicle payload.

ONBOARD SCALES LIMITATIONS

You cannot use the system if any of the following occur:

- The wheels are not pointed straight ahead.
- Your vehicle is not in park (P).
- Your vehicle is not on a level surface.
- The tire pressures are below the recommended levels.
- Your vehicle is off.

USING ONBOARD SCALES

From the features menu, press Onboard Scales. See **Center Display** (page 558).

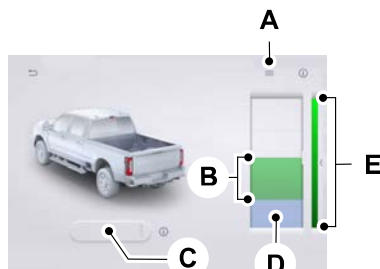

- A. Settings menu.
- B. Estimated payload.
- C. Tail lamps on and off.
- D. Passenger and Cargo Load Reminder.
- E. Vehicle capacity range.

Tail Lamps

Press to see the estimated payload on the vehicle's tail lamps.

Onboard Scales Settings

Vehicle Mode

Press to see the current estimated payload.

Scale Mode

Press to see a representation of the weight added to the vehicle's current payload and to reset scale mode to zero.

Passenger and Cargo Load Reminder

Press to switch the load reminder on or off.

Set Passenger and Cargo Load Reminder

Press to set a value of weight to be considered in the vehicle that is not present while the vehicle is being loaded.

Onboard Scales (If Equipped)

Example of application: Passenger(s) weight.

The default and minimum value is 75 kg (150 lb).

The maximum value is 700 kg (1,550 lb).

Press **Set Current Load as Estimate** to store the immediate payload reading as a Passenger and Cargo Load Reminder.

Measurement Units

Press to change measurement units between pounds and kilograms.

Trailer Backup Assistance (If Equipped)

WHAT IS TRAILER BACKUP ASSISTANCE

Trailer backup assistance utilizes the control knob on the instrument panel to help you steer a trailer. Turn the control knob in the direction you want the trailer to go and the system steers the vehicle.

HOW DOES TRAILER BACKUP ASSISTANCE WORK

Trailer backup assistance uses a sticker or sensor attached to the trailer to detect the trailer angle relative to the towing vehicle and provides instructions, graphics and camera views on the touchscreen.

TRAILER BACKUP ASSISTANCE PRECAUTIONS



WARNING: Driving while distracted can result in loss of vehicle control, crash and injury. We strongly recommend that you use extreme caution when using any device that may take your focus off the road. Your primary responsibility is the safe operation of your vehicle. We recommend against the use of any hand-held device while driving and encourage the use of voice-operated systems when possible. Make sure you are aware of all applicable local laws that may affect the use of electronic devices while driving.



WARNING: This system does not automatically brake your vehicle. This system is an extra driving aid. It does not replace your attention and judgment, or the need to apply the brakes. If you do not apply the brakes when necessary, you may collide with another vehicle or other objects.

Note: *The system is not a substitute for safe driving practices. Always be aware of your vehicle and trailer combination, and the surrounding environment.*

Note: *The system does not detect or prevent your vehicle or trailer from making contact with obstacles in the surrounding environment.*

Note: *The front end of your vehicle swings out when changing the direction of the trailer.*

Note: *In certain conditions, the trailer could turn faster or the trailer angle could increase more than anticipated. Always monitor the clearance between the trailer and vehicle and the surroundings.*

SETTING UP THE TRAILER BACKUP ASSISTANCE FOR A CONVENTIONAL TRAILER

CONFIGURING THE TRAILER

You must configure a trailer in the system to use trailer backup assistance. This is a one-time setup process and the system saves the trailer information for the next time you use that trailer.

The system only works with conventional trailers. It does not work with other types including fifth-wheel and gooseneck. The following illustration shows examples of conventional trailers on the left-hand side.

Trailer Backup Assistance (If Equipped)

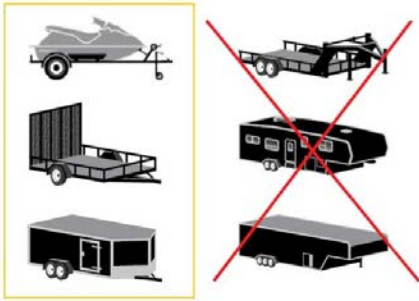

Make sure that the trailer and your vehicle are in line with each other. You can do this by putting the transmission in drive (D) and pulling straight forward.

Configuring the Trailer in the Touchscreen

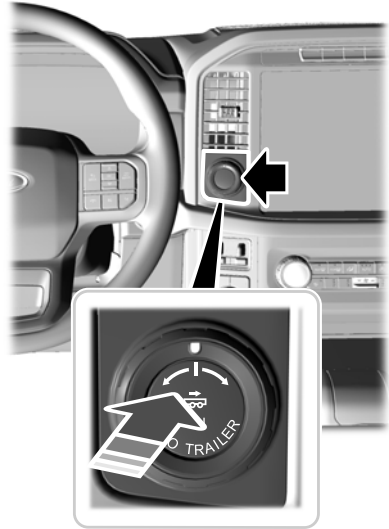

Positioning the Trailer

Hitch the trailer to your vehicle and connect the electrical wiring harness. Check to make sure that the wiring is working. See **Connecting a Trailer** (page 359).



Park your vehicle and hitched trailer on a level surface.

For best results, make sure that your trailer rides level with the ground when you hitch your vehicle. See **Connecting a Trailer** (page 359).



1. Press the button to switch the system on.
2. Press **Yes** to indicate that a trailer is connected.
3. Press **Add Trailer** on the touchscreen.
4. Follow the directions on the touchscreen to enter the trailer name and trailer type, then proceed to the sticker or sensor setup.

Trailer Backup Assistance (If Equipped)

Note: Your vehicle has two options for trailer backup assistance set up. The system defaults to the camera based system. See **Applying the Trailer Reversing Aid Sticker** (page 391). You can also set up the system with the trailer sensor that you can purchase from your authorized dealer. You must connect the sensor to your vehicle to set up the system. See **Trailer Sensor Installation** (page 391).

Note: If you configure the trailer and install a sensor, the system saves the trailer with that sensor information. If you want to use this trailer with the sticker, you need to delete the trailer from the system and repeat the setup process.

APPLYING THE TRAILER REVERSING AID STICKER

Place the sticker in an area visible by the rear view camera. The entire sticker must be within 10–48 cm (4–19 in) from the center of the hitch ball, as shown in the following illustration.

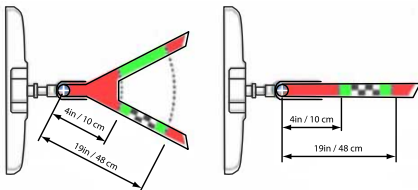

Use the supplied sticker placement card, a tape measure and pen to carefully mark the area to attach the sticker. Make sure the entire sticker is within the green zone between the two arcs or distance markers on the diagram, and is also visible in the rear view camera display.

Once you have found the correct location, place the sticker.

Note: Make sure nothing can obstruct the rear view camera's view of the sticker such as a jack handle or wiring.

Note: Position the sticker on a flat, dry and clean horizontal surface. For best results, apply the sticker when temperatures are above 0°C (32°F).

Note: Do not move stickers after placing them. Do not re-use any stickers if removed.

Note: You can purchase additional stickers through your authorized dealer.

Note: If you previously setup the trailer with the trailer sensor, make sure it is not plugged in before configuring the trailer and placing the sticker.

TRAILER SENSOR INSTALLATION

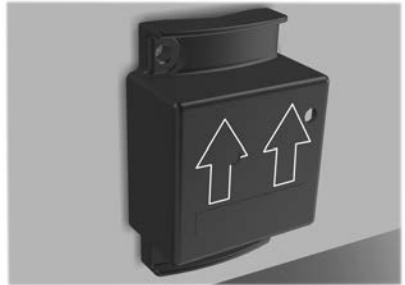

Trailer Backup Assistance (If Equipped)



Refer to the instructions included with your trailer sensor for detailed information regarding installation.

Note: Make sure the arrows on the sensor housing are facing up. Mount the sensor to a vertical part of the trailer that pivots when you turn your vehicle. Do not mount to a stationary surface such as the truck side of the trailer hitch.

CALIBRATING THE SYSTEM

Calibrating the system requires driving forward and turning left or right. Follow the instructions on the touchscreen to complete the calibration process.

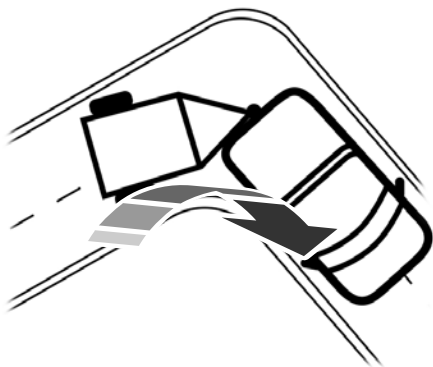

Note: To calibrate the system, you need an area where you can safely drive forward and turn left or right. An open parking lot is an ideal place to perform the calibration.

Note: Keep the steering wheel straight when instructed to by the touchscreen. If the steering wheel is in a turned position during this instruction, the calibration pauses.

Note: During calibration, the system determines the trailer length. The system supports trailer lengths of 1.85–10.05 m (6–33 ft) distance from the hitch point to the center of the axle or axles. The system is designed to work with drawbars that have a license plate to hitch ball center measurement of 23–46 cm (9–18 in) when installed. Do not attempt to use drawbars or trailers that have a length outside of this range as the system performance degrades and could cause improper system function.

Note: The touchscreen shows if you are going too slow or fast. Calibration pauses if the speed is outside the required range of 4–15 km/h (2–9 mph).

Note: You need to complete at least a 90° turn, and longer trailers could require a 180° turn. Camera trailer tracking requires the system to locate the hitch ball as well as determine the trailer length. Some trailers could require you to drive straight then turn multiple times before calibration completes. The touchscreen provides instructions and notifies you when calibration completes.

Note: For best results, do not calibrate the system at night when calibrating the system with the sticker.

Trailer Backup Assistance (If Equipped)

SETTING UP THE TRAILER BACKUP ASSISTANCE FOR A FIFTH-WHEEL OR GOOSENECK TRAILER

CONFIGURING THE TRAILER

You must configure a trailer in the system to use trailer backup assistance. This is a one-time setup process and the trailer information is saved in the system for the next time you use that trailer.

The following illustration shows examples of fifth-wheel and gooseneck trailers.

Note: *Trailer reverse guidance camera views are available with no trailer setup. However, complete functionality including graphics and automatic view switching is enabled by setup. Setup is required to enable trailer backup assistance.*



Configuring the Trailer in the Instrument Cluster Display



1. Press the button to switch the system on.
2. Using the instrument cluster controls on the steering wheel, select **Add Trailer**.
3. Add a personalized name for the trailer using the instrument cluster display prompts. Use the down arrow to scroll to the preferred letter and then press the right arrow to advance to the next letter. Press the **OK** button.

4. Select the trailer brake type.

Note: *Select **Default Electric/Surge/None** if the trailer has electric, surge or no brakes.*

5. Select the trailer brake effort.

Trailer Backup Assistance (If Equipped)

Note: The default value is **Low** and is the recommended setting for most trailers. Select a different setting if your trailer's brakes require more initial voltage, or you prefer more aggressive trailer braking.

6. Select the trailer type.

Note: The system could prompt you to setup **Trailer Blind Spot** before continuing the setup process.

7. Select whether you want to add the feature.

TRAILER SENSOR INSTALLATION

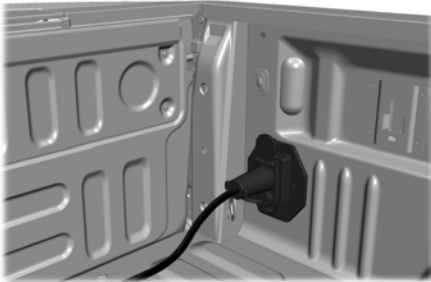

To use the system with a fifth-wheel or gooseneck trailer, you must install a sensor. Refer to the instructions in the sensor kit for proper installation.

Note: Make sure the arrows on the sensor housing are facing up. Mount the sensor to a vertical part of the trailer that pivots and moves when you turn your vehicle. Do not mount to a stationary surface or to the truck side of the fifth wheel-trailer hitch.

Note: You need to replace the 7/4 way connector in the bumper with the recommended 7/12 pin connector if your vehicle did not come with the fifth-wheel prep package. See your authorized dealer.

Note: If your vehicle has the fifth-wheel prep package, you have everything you need. If your vehicle does not have the fifth-wheel prep package, see your authorized dealer to purchase the sensor kit and the 7/12 pin connector.

CALIBRATING THE SYSTEM

Calibrating the system requires driving forward and turning left or right. Follow the instructions on the touchscreen to complete the calibration process.

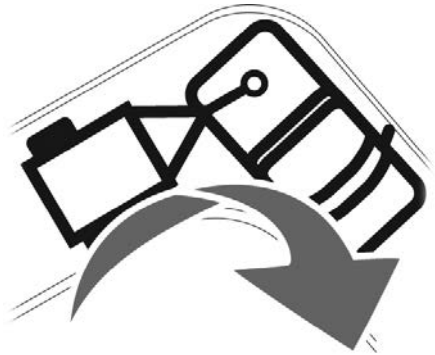

Note: Calibrating the system requires an area where you can safely drive forward and turn left or right. An open parking lot is an ideal place to perform the calibration.

Trailer Backup Assistance (If Equipped)

Note: Keep the steering wheel straight when instructed to by the touchscreen. If the steering wheel is in a turned position during this instruction, the calibration pauses.

Note: During calibration, the system determines the trailer length. The system supports trailer lengths of 3–11.94 m (10–39 ft) distance from the hitch point to the center of the axle or axles.

Note: The touchscreen shows if you are going too slow or fast. Calibration pauses if the speed is outside the required range of 4–25 km/h (2–16 mph).

Note: You need to complete at least a 90° turn, and longer trailers could require a 180° turn.

SWITCHING TRAILER BACKUP ASSISTANCE ON AND OFF

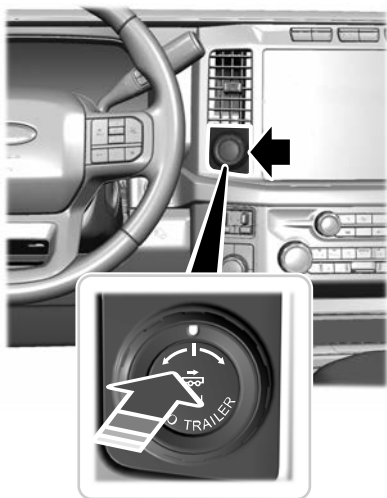

Press the button and use the touchscreen to select the connected trailer.

Note: A trailer must be configured to use trailer backup assistance. See **Configuring the Trailer** (page 389).

Note: If you use the steering wheel when using trailer backup assistance, the system turns off and a message displays in the touchscreen.

Note: If the trailer was connected just prior to turning the system on, you may need to drive forward to initialize the system. Follow the instructions on the touchscreen to activate the system.

USING THE TRAILER BACKUP ASSISTANCE CONTROLLER

Use the control knob to steer the trailer. Take your hands off the steering wheel and turn the control knob instead. The control knob acts as the steering control for the trailer.

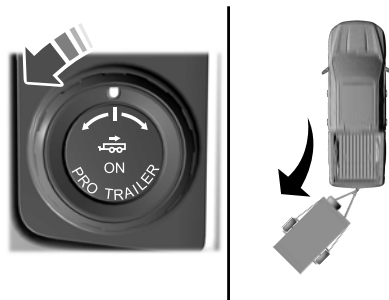

Turn and hold counterclockwise to make the trailer go left.

Trailer Backup Assistance (If Equipped)

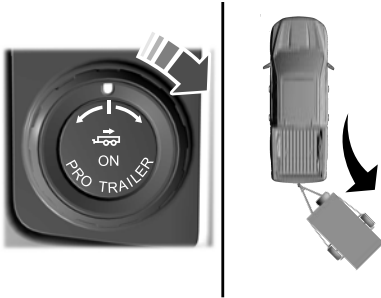

Turn and hold clockwise to make the trailer go right.

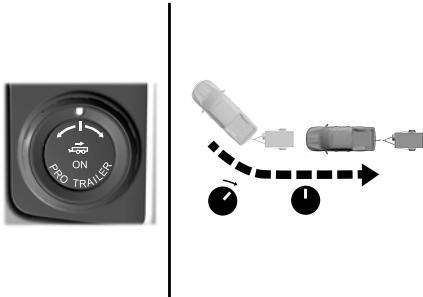

Release the knob when the trailer is moving in the direction you want.

Note: The more you turn the knob, the sharper the trailer turns.

Note: Quickly turning and releasing the knob results in a jerky movement of the vehicle.

Note: You may have to use the knob to correct the trailer direction when attempting to move the trailer straight back under some conditions.

USING THE TRAILER BACKUP ASSISTANCE VIEWS

Up to seven camera views could be available when using trailer backup assistance. Use the view that helps you the most when reversing your vehicle and trailer.

Note: The rear view camera view is available on all vehicles with trailer backup assistance. Additional views are available on vehicles with trailer reverse guidance.

 360° camera view. Shows a 360° view on the right-hand side of the touchscreen with a rear camera view on the left-hand side of the touchscreen.

 Rear view camera view. Shows your trailer hitch or what is directly behind your vehicle.

 Rear split view camera view. Shows a 180° degree view of what is behind your vehicle.

 Bed camera view. Shows the truck bed.

Note: This view also provides a picture-in-picture view.

 Trailer AUX camera view. Shows a rear view camera image of what is behind your trailer. You need to separately purchase this camera and have it installed.

Note: This view also provides a picture-in-picture view.

 Trailer reverse guidance view. Shows you a view of the sides of your truck and the trailer. In auto mode, this view moves as the trailer moves so that you do not have to adjust the camera as you turn. Left and right arrows let you see other camera views.

Trailer Backup Assistance (If Equipped)



Picture-in-picture view. Shows a main view and a secondary view when in bed camera view or trailer AUX camera view.

Note: If you have a 20 cm (8 in) touchscreen, picture-in-picture is off by default. Press the picture-in-picture icon on the touchscreen to switch picture-in-picture view on and off.

Note: If you have a 30 cm (12 in) touchscreen, picture-in-picture is on by default and you cannot switch it off.



Swap. Press to swap between picture-in-picture views.

Auto

Auto. Press to return to auto view.

Note: Auto is the default setting.

Hitch Angle Graphic

The hitch angle graphic shows a small representation of your truck and trailer with visual feedback to help you monitor the trailer. The graphic shows two different colored lines for the trailer hitch angle. A black line shows you where your trailer is in relation to your vehicle. The white line represents the amount the trailer can turn based on knob input.

The graphic shows a yellow and red zone for the hitch angle to warn you of a high angle condition that could require you to pull forward to reduce the hitch angle. The angle limits for each zone vary based on the trailer length.

The yellow zone indicates you are approaching the maximum controllable trailer angle for the system. When the trailer enters this zone, it is more difficult to reduce the trailer turn when backing up. It may be necessary to put your vehicle back into drive (D) and pull forward to get the truck and trailer back to an in-line position.

The red zone indicates you have exceeded the maximum controllable trailer angle for the system. Immediately stop reversing. Put your vehicle into drive (D) and pull forward until the trailer is no longer in the red zone.

Setting the Trailer Angle Limit

1. Press **Features** on the touchscreen.
2. Press **Towing**.
3. Press **Manage trailers**.
4. Press **Pro Trailer Backup Assist**.
5. Press **Trailer Angle Limit**.
6. Press a setting.

Normal Control Angle

Default setting. This provides a balanced limit that returns from a turn to straight backing with minimal change to the trailer direction.

Max Control Angle

Increases the trailer angle limit close to the maximum controllable angle to allow sharper turns but also causes more change in the trailer direction when straightening out from a turn.

Trailer Backup Assistance (If Equipped)

TRAILER BACKUP ASSISTANCE – TROUBLESHOOTING

TRAILER BACKUP ASSISTANCE – INFORMATION MESSAGES

Message	Description
Detecting Trailer Please Wait...	Displays when the system turns on and is initializing.
Pro Trailer Backup Assist™ System is Not Available	A condition exists that prevents the system from turning on. If the message continues to display have your vehicle checked as soon as possible.
Pro Trailer Backup Assist™ Driving Required to Initialize Steering Press Knob to Exit	The steering system needs to learn internal parameters to fully enable the feature. Drive your vehicle straight forward above 40 km/h (25 mph) for approximately 5 minutes.
Pro Trailer Backup Assist™ Stop now Maximum trailer angle Press Knob to Exit	Displays when you reach the maximum controllable trailer angle for the system. Place your vehicle in drive (D) and pull forward to get the truck and trailer back to an in-line position. If this message consistently displays, you may need to repeat the trailer calibration. Delete the trailer from the system and repeat the setup and calibration process.
Stop now. Deactivated by trailer angle.	Displays when you exceed the maximum controllable trailer angle for the system. Place your vehicle in drive (D) and pull forward to get your vehicle and trailer back to an in-line position, then activate the system by selecting the connected trailer and following the instructions on the touchscreen. If this message consistently displays, you may need to repeat the trailer setup and calibration. Delete the trailer from the system and repeat the setup and calibration process.
Pro Trailer Backup Assist™ Stop Now Take Control of Steering Wheel	Displays when the system can no longer steer the vehicle and you must take over steering.

Trailer Backup Assistance (If Equipped)

Message	Description
Pro Trailer Backup Assist™ Sensor Not Detected Refer to Owner's Manual Press Knob to Exit	Displays when the system does not detect the sensor. Check the sensor connection, check that there is no damaged wiring between the connector and sensor and check that there is only one sensor connected. If you do not want to use the sensor for this trailer, delete the trailer in the touchscreen then repeat the setup process with the sticker.
Pro Trailer Backup Assist™ Trailer Not Detected. Shift to Park Press Knob to Exit	These messages display when the system does not detect the trailer.
Pro Trailer Backup Assist™ Trailer Not Detected. Refer to Owner's Manual. Press Knob to Exit	If your trailer is set up with a sticker, make sure the rear camera is clean, and the sticker is clearly visible in the camera image. You can also move the trailer forward or backward to change the trailer position and lighting conditions. If your trailer is set up with a sensor, check that the sensor is correctly installed and the trailer length is within the allowed range. If these messages continue to display, have your vehicle checked as soon as possible.
Pro Trailer Backup Assist™ Trailer Not Detected Pull Forward to Initialize Press Knob to Exit	For trailers set up with a sensor, this message displays when your vehicle has not moved after the trailer sensor is connected or extended operation below 1 km/h (1 mph). Drive forward above 3 km/h (2 mph) to initialize the system.
Pro Trailer Backup Assist™ Stop Now System Not Active Press Knob to Exit	Displays when your vehicle is backing up but the system is not activated. Select the connected trailer on the touchscreen and follow the instructions to activate the system. This message also displays when you back up during the calibration process.
Pro Trailer Backup Assist™ Backup Slowly Turn Knob to Steer Press Knob to Exit	Displays when the system turns on and is available to use.

Trailer Backup Assistance (If Equipped)

TRAILER BACKUP ASSISTANCE – FREQUENTLY ASKED QUESTIONS

Why does the trailer not reverse straight?

Verify the sensor is correctly installed. Other factors such as the hitch connection, road camber, road slope and trailer suspension could influence how straight the system can reverse the trailer when the control knob is not turned. You can compensate for the trailer drifting to the right or left by slowly turning the knob until the trailer is following your desired path and then holding the knob in that position.

Why does the system not detect a sensor?

There could be an issue with the connection, the wiring harness could be damaged, you could have multiple sensors connected or the sensor could be incorrectly installed. Check that the 12-way connector is fully inserted into the 12-way socket. The red rubber seal is not visible when the connector is fully inserted. Also check that the wiring harness sensor connection is fully inserted at the trailer sensor, and check for damaged wiring between the 12-way connector and the trailer sensor. Also, check that the sensor is installed on a vertical surface with the arrows pointing straight up.

What does it mean if the system remains on one message for an extended time during calibration when setting up the system with the sticker?

The camera could need to be cleaned, the sticker could be blocked, the drawbar could be outside the allowed range of 10–48 cm (4–19 in) or you could need to move to a different area to change the lighting and background. Verify the sticker is in the proper location. See **Applying the Trailer Reversing Aid Sticker** (page 391). You can move to a different area or change the direction you are driving or setup the system at a different time of day. Some trailers are not compatible with the sticker and camera system. If the issue persists with the sticker setup, you may choose to setup the trailer with a sensor.

What does it mean if the system pauses during calibration?

There could be steering input or trailer movement during the straight drive portion of the calibration process.

What does it mean if the system remains on one message for an extended time during calibration when setting up the system with the sensor?

The sensor could be incorrectly installed, the trailer length could be outside the allowed range or the road surface could be too rough or bumpy.

What does it mean if the system displays hold steering steady during turn?

Part of the calibration process for the sticker setup requires a steady turn. If you are continually moving the steering wheel during the turn, this delays the calibration process. To enable the calibration process, hold the steering wheel at the same position when turning.

Trailer Backup Assistance (If Equipped)

What does it mean if the system displays that it is not available?

There could be a sub-system that the system uses that is not correctly operating or there could be a battery voltage issue. If the system continues to display it is not available, visit your authorized dealer to have your vehicle checked.

What does it mean if the system displays that driving is required to initialize steering?

The steering system needs to learn internal parameters to fully turn on the feature. Drive your vehicle straight forward above 40 km/h (25 mph) for approximately 5 minutes. This could also occur when your vehicle is new, there is a battery voltage issue or if the steering system has been serviced.

What does it mean if the system does not detect a trailer when configured with a sensor?

Verify that the sensor is properly connected. See **Trailer Sensor Installation** (page 391). Repeat calibration on a different route if you have verified sensor installation.

What does it mean if the system requires you to pull forward to initialize?

This occurs when the vehicle has not moved during the current key cycle after you connect and select the trailer in the touchscreen or you operate the system at speeds below 1 km/h (1 mph) for an extended period of time. Drive forward above 3 km/h (2 mph) and the system indicates when it initializes.

What does it mean if the trailer is at its maximum angle or the system deactivated by trailer angle?

You are at the maximum controllable trailer angle for the system. Place your vehicle in drive (D) and pull forward to get the truck and trailer back to an in-line position. If this message consistently displays, this could indicate the sensor is incorrectly installed, the trailer needs to be recalibrated or the drawbar or the trailer dimensions are outside of the supported range. The system is designed to work with drawbars that have a license plate to hitch ball center measurement of 23–46 cm (9–18 in) when installed. The system is designed to work with trailers that have a hitch point to center of the axle or axles measurement of 1.85–10.05 m (6–33 ft). Do not attempt to use drawbars or trailers that have a length outside of this range as the system performance degrades and could cause improper system function. Check that the correct trailer is selected in the touchscreen. Verify the sensor is installed according to the instructions included in the sensor kit and check that the drawbar and the trailer dimensions are within the allowed range. Then, delete the trailer from the system and repeat the setup process to calibrate the trailer.

Trailer Backup Assistance (If Equipped)

What does it mean when the system tells you to take control of the steering wheel?

The system is no longer steering the vehicle and you must take over steering. There are four reasons the system could display this message. The first reason the system could display this message is that you have touched the steering wheel when the system is steering. The second reason the system could display this message is that you have exceeded the maximum speed for the feature. The third reason the system could display this message is that the trailer is not detected. The final reason the system could display this message is that an internal condition for system operation is not met that requires your vehicle to return to manual control of the steering.

How do I use a sticker if I have previously setup a trailer with the sensor?

Disconnect the sensor wiring and add a new trailer to the system and follow the instructions for setup with a sticker. See **Applying the Trailer Reversing Aid Sticker** (page 391). If your vehicle does not support the sticker option, the touchscreen instructs you to install the sensor again.

What if I want to use a sensor for the trailer instead of a sticker?

Install the sensor and connect the sensor wiring before adding the new trailer to the system. You must connect the sensor before you add the trailer. If your vehicle did not come with a sensor, you can purchase one from your authorized dealer.

What does it mean if the system does not detect a trailer that is setup with a sticker?

The system requires a clear view of the sticker placed on the trailer. You must keep the camera lens and sticker clean for the system to correctly operate. If the system cannot initially detect the trailer, it could be necessary for you to change the lighting conditions by moving your vehicle and trailer or waiting until the conditions change. See **Applying the Trailer Reversing Aid Sticker** (page 391). Some trailers are not compatible with the sticker and camera system. If the system consistently does not detect the trailer with the sticker setup, you may choose to setup the trailer with a sensor.

Note: *The system is designed to be used with the same trailer connection every time you choose the trailer from the touchscreen. When using a different drawbar or a different pin hole on drawbars with more than one, connecting the drawbar to your vehicle affects the trailer position and you may need to repeat the trailer setup and calibration process.*

Trailer Reverse Guidance (If Equipped)

WHAT IS TRAILER REVERSE GUIDANCE

Trailer reverse guidance provides views and graphics on the touchscreen to help you steer your vehicle when you backup a trailer.

HOW DOES TRAILER REVERSE GUIDANCE WORK

Trailer reverse guidance uses a sticker or sensor attached to the trailer to detect the trailer angle relative to the towing vehicle and provides instructions, graphics and camera views on the touchscreen.

TRAILER REVERSE GUIDANCE PRECAUTIONS



WARNING: Driving while distracted can result in loss of vehicle control, crash and injury. We strongly recommend that you use extreme caution when using any device that may take your focus off the road. Your primary responsibility is the safe operation of your vehicle. We recommend against the use of any hand-held device while driving and encourage the use of voice-operated systems when possible. Make sure you are aware of all applicable local laws that may affect the use of electronic devices while driving.



WARNING: This system does not automatically brake your vehicle. This system is an extra driving aid. It does not replace your attention and judgment, or the need to apply the brakes. If you do not apply the brakes when necessary, you may collide with another vehicle or other objects.

Note: The system is not a substitute for safe driving practices. Always be aware of your vehicle and trailer combination, and the surrounding environment.

Note: The system does not detect or prevent your vehicle or trailer from making contact with obstacles in the surrounding environment.

Note: The front end of your vehicle swings out when changing the direction of the trailer.

Note: In certain conditions, the trailer could turn faster or the trailer angle could increase more than anticipated. Always monitor the clearance between the trailer and vehicle and the surroundings.

SETTING UP TRAILER REVERSE GUIDANCE FOR A CONVENTIONAL TRAILER

CONFIGURING THE TRAILER

You must configure a trailer in the system to use trailer reverse guidance. This is a one-time setup process and the trailer information is saved in the system for the next time you use that trailer.

The system only works with conventional trailers. It does not work with other types including fifth-wheel and gooseneck. The following illustration shows examples of conventional trailers on the left-hand side.

Note: Trailer reverse guidance camera views are available with no trailer setup. However, complete functionality including graphics and automatic view switching is enabled by setup. Setup is required to enable trailer backup assistance.

Trailer Reverse Guidance (If Equipped)

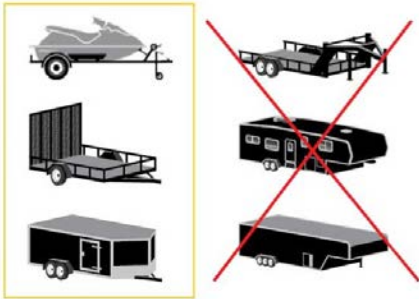

Positioning the Trailer

Hitch the trailer to your vehicle and connect the electrical wiring harness. Check to make sure that the wiring is working. See **Connecting a Trailer** (page 359).



Park your vehicle and hitched trailer on a level surface.

For best results, make sure that your trailer rides level with the ground when you hitch your vehicle. See **Connecting a Trailer** (page 359).



Make sure that the trailer and your vehicle are in line with each other. You can do this by putting the transmission in drive (D) and pulling straight forward.

Configuring the Trailer in the Touchscreen

1. Shift to reverse (R).
2. Press the camera view button.
3. Press the trailer view icon.
4. Press **Add Trailer**.
5. Follow the directions on the touchscreen to enter the trailer name and trailer type, then proceed to the sticker or sensor setup.

Note: If you configure the trailer and install a sensor, the trailer is saved with that sensor information. If you want to use this trailer with the sticker, you need to delete the trailer from the system and repeat the setup process.

Note: Your vehicle has two options for the trailer reversing aid setup. If your vehicle came with a trailer sensor kit or if a message displays to install a sensor, follow the sensor installation instructions. See **Trailer Sensor Installation** (page 405). If your vehicle did not come with a trailer sensor kit, follow the sticker installation instructions. See **Applying the Trailer Reverse Aid Sticker** (page 405).

Note: If your vehicle came with a trailer sensor kit, the vehicle will receive an update that allows the system to operate with a sensor or sticker. If your vehicle did not come with a trailer sensor kit, your vehicle can be setup using either method, but you need to separately purchase the trailer sensor kit from your authorized dealer.

Trailer Reverse Guidance (If Equipped)

APPLYING THE TRAILER REVERSE AID STICKER

Place the sticker in an area visible by the rear view camera. The entire sticker must be within 10–48 cm (4–19 in) from the center of the hitch ball, as shown in the following illustration.

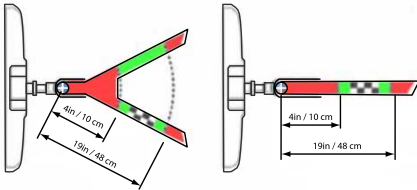

Use the supplied sticker placement card, a tape measure and pen to carefully mark the area to attach the sticker. Make sure the entire sticker is within the green zone between the two arcs or distance markers on the diagram, and is also visible in the rear view camera display.

Once you have found the correct location, place the sticker.

Note: Make sure nothing can obstruct the rear view camera's view of the sticker such as a jack handle or wiring.

Note: Position the sticker on a flat, dry and clean horizontal surface. For best results, apply the sticker when temperatures are above 0°C (32°F).

Note: Do not move stickers after placing them. Do not reuse any stickers if removed.

Note: You can purchase additional stickers through your authorized dealer.

Note: If you previously set up the trailer with the trailer sensor, make sure it is not plugged in before configuring the trailer and placing the sticker.

TRAILER SENSOR INSTALLATION

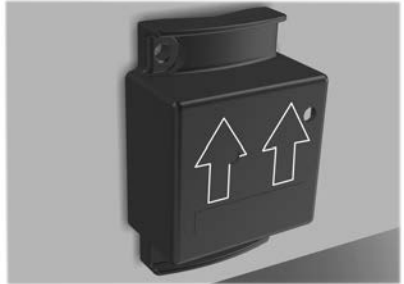

Refer to the instructions included with your trailer sensor for detailed information regarding installation.

Note: Make sure the arrows on the sensor housing are facing up. Mount the sensor to a vertical part of the trailer that pivots when you turn your vehicle. Do not mount to a stationary surface such as the truck side of the trailer hitch.

Trailer Reverse Guidance (If Equipped)

Note: If your vehicle came with a trailer sensor kit, the vehicle will receive an update that allows the system to operate with a sensor or sticker. If your vehicle did not come with a trailer sensor kit, your vehicle can be setup using either method, but you need to separately purchase the trailer sensor kit from your authorized dealer. Once your vehicle is enabled for sticker setup, the default setup for new trailers requires placement of the sticker. To setup a trailer with a sensor, install the sensor on the trailer and plug the connector into the connector in your bumper prior to configuring the trailer. Trailers that were set up with a sensor still require the sensor to function. To change a trailer to use the sticker, delete the trailer in the system and repeat the trailer setup with the sticker.

CALIBRATING THE SYSTEM

Calibrating the system requires driving forward and turning left or right. Follow the instructions on the touchscreen to complete the calibration process.



Note: To calibrate the system, you need an area where you can safely drive forward and turn left or right. An open parking lot is an ideal place to perform the calibration.

Note: Keep the steering wheel straight when instructed to by the touchscreen. If the steering wheel is in a turned position during this instruction, the calibration pauses.

Note: During calibration, the system determines the trailer length. The system supports trailer lengths of 1.85–10.05 m (6–33 ft) distance from the hitch point to the center of the axle or axles. The system is designed to work with drawbars that have a license plate to hitch ball center measurement of 23–46 cm (9–18 in) when installed. Do not attempt to use drawbars or trailers that have a length outside of this range as the system performance degrades and could cause improper system function.

Note: The touchscreen shows if you are going too slow or fast. Calibration pauses if the speed is outside the required range of 4–15 km/h (2–9 mph).

Note: You need to complete at least a 90° turn, and longer trailers could require a 180° turn. Camera trailer tracking requires the system to locate the hitch ball as well as determine the trailer length. Some trailers could require you to drive straight then turn multiple times before calibration completes. The touchscreen provides instructions and notifies you when calibration completes.

Note: For best results, do not calibrate the system at night when calibrating the system with the sticker.

SWITCHING TRAILER REVERSE GUIDANCE ON AND OFF

Shift into reverse (R), press the rear camera button to expand the menu, press the trailer icon and use the touchscreen to select the connected trailer.

Trailer Reverse Guidance (If Equipped)

Note: If the trailer was connected just prior to turning the system on, you may need to drive forward to initialize the system. Follow the instructions on the touchscreen to activate the system.

USING TRAILER REVERSE GUIDANCE VIEWS

Up to seven camera views could be available when using trailer reverse guidance. Use the view that helps you the most when reversing your vehicle and trailer.



360° camera view. Shows a 360° view on the right-hand side of the touchscreen with a rear camera view on the left-hand side of the touchscreen.



Rear view camera view. Shows your trailer hitch or what is directly behind your vehicle.



Bed camera view. Shows the truck bed.

Note: This view also provides a picture-in-picture view.



Trailer AUX camera view. Shows a rear view camera image of what is behind your trailer. You need to separately purchase this camera and have it installed.

Note: This view also provides a picture-in-picture view.



Trailer reverse guidance view. Shows you a view of the sides of your truck and the trailer. In auto mode, this view moves as the trailer moves so that you do not have to adjust the camera as you turn. Left and right arrows let you see other camera views.



Straight backup mode. Shows which way to turn your steering wheel to keep the trailer straight.

Use this view when you want to keep your trailer completely in line with your truck.

Note: This view also provides a picture-in-picture view.

Note: It may be helpful to shift your vehicle into drive (D), pull forward and straighten out the vehicle and trailer before engaging straight backup mode.



Picture-in-picture view. Shows a main view and a secondary view when in bed camera view,

trailer AUX camera view or straight backup mode.

Note: If you have a 20 cm (8 in) touchscreen, picture-in-picture is off by default. Press the picture-in-picture icon on the touchscreen to switch picture-in-picture view on and off.

Note: If you have a 30 cm (12 in) touchscreen, picture-in-picture is on by default for bed camera view and trailer AUX camera view and cannot be switched off. Press the picture-in-picture icon on the touchscreen to switch picture-in-picture view on and off in straight backup mode.



Swap. Press to swap between picture-in-picture views.



This takes you back to the 360° camera system and out of the trailer reverse guidance feature.



Auto. Press to return to auto view.

Note: Auto mode is the default setting.

Trailer Reverse Guidance (If Equipped)

Hitch Angle Graphic



The hitch angle graphic shows a small representation of your truck and trailer with visual feedback to help you monitor the trailer. The graphic shows two different colored lines for the trailer hitch angle. A black line shows you where your trailer is in relation to your vehicle. The white line represents the amount the trailer can turn based on steering wheel position.

The graphic shows a yellow and red zone for the hitch angle to warn you of a high angle condition that could require you to pull forward to reduce the hitch angle. The angle limits for each zone vary based on the trailer length.

The yellow zone indicates you are approaching the maximum controllable trailer angle for the system. When the trailer enters this zone, it is more difficult to reduce the trailer turn when backing up. It may be necessary to put your vehicle back into drive (D) and pull forward to get the truck and trailer back to an in-line position.

The red zone indicates you have exceeded the maximum controllable trailer angle for the system. Immediately stop reversing. Put your vehicle into drive (D) and pull forward until the trailer is no longer in the red zone.

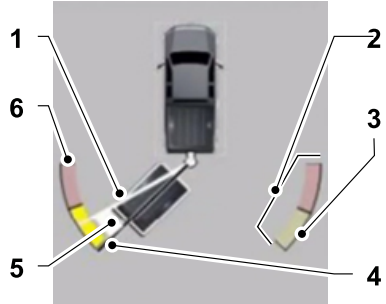

1. Projected line.
2. Dynamic warning zones.
3. Approaching point of no return zone.
4. Current trailer angle.
5. Projection bar.
6. Approaching trailer jackknife zone

Trailer Reverse Guidance (If Equipped)

TRAILER REVERSE GUIDANCE – TROUBLESHOOTING

TRAILER REVERSE GUIDANCE – INFORMATION MESSAGES

Message	Description
Detecting Trailer Please Wait...	Displays when the system turns on and is initializing.
Trailer Reverse Guidance System is Not Available	A condition exists that prevents the system from turning on. If the message continues to display, visit your authorized dealer to have your vehicle checked.
Trailer Reverse Guidance Driving Required to Initialize Steering Press OK to Exit	The steering system needs to learn internal parameters to fully enable the feature. Drive your vehicle straight forward above 40 km/h (25 mph) for approximately 5 minutes.
Stop now. Deactivated by trailer angle.	Displays when you exceed the maximum controllable trailer angle for the system. Place your vehicle in drive (D) and pull forward to get your vehicle and trailer back to an in-line position, then activate the system by selecting the connected trailer and following the instructions on the touchscreen. If this message consistently displays, you may need to repeat the trailer setup and calibration. Delete the trailer from the system and repeat the setup and calibration process.
Trailer Reverse Guidance Sensor Not Detected Refer to Owner's Manual Press OK to Exit	Displays when the system does not detect the sensor. Check the sensor connection, check that there is no damaged wiring between the connector and sensor and check that there is only one sensor connected. If you do not want to use the sensor for this trailer, delete the trailer in the touchscreen then repeat the setup process with the sticker.

Trailer Reverse Guidance (If Equipped)

Message	Description
Trailer Reverse Guidance Trailer Not Detected. Refer to Owner's Manual. Press OK to Exit	<p>Displays when the system does not detect the trailer.</p> <p>If your trailer is setup with a sticker, make sure the rear camera is clean, and the sticker is clearly visible in the camera image. You can also move the trailer forward or backward to change the trailer position and lighting conditions.</p> <p>If your trailer is setup with a sensor, check that the sensor is correctly installed and the trailer length is within the allowed range.</p> <p>If this message continues to display, visit your authorized dealer to have your vehicle checked.</p>
Trailer Reverse Guidance Trailer Not Detected Pull Forward to Initialize Press OK to Exit	<p>Displays when your vehicle has not moved after the trailer sensor is connected or extended operation below 1 km/h (1 mph). Drive forward above 3 km/h (2 mph) to initialize the system.</p>

Trailer Reverse Guidance (If Equipped)

TRAILER REVERSE GUIDANCE – FREQUENTLY ASKED QUESTIONS

Why does the trailer not reverse straight?

Verify the sensor is correctly installed. Other factors such as the hitch connection, road camber, road slope and trailer suspension could influence how straight the system can reverse the trailer when the control knob is not turned. You can compensate for the trailer drifting to the right or left by slowly turning the knob until the trailer is following your desired path and then holding the knob in that position.

Why does the system not detect a sensor?

There could be an issue with the connection, the wiring harness could be damaged, you could have multiple sensors connected or the sensor could be incorrectly installed. Check that the 12-way connector is fully inserted into the 12-way socket. The red rubber seal is not visible when the connector is fully inserted. Also check that the wiring harness sensor connection is fully inserted at the trailer sensor, and check for damaged wiring between the 12-way connector and the trailer sensor. Also, check that the sensor is installed on a vertical surface with the arrows pointing straight up.

What does it mean if the system remains on one message for an extended time during calibration when setting up the system with the sticker?

The camera could need to be cleaned, the sticker could be blocked, the drawbar could be outside the allowed range of 10–48 cm (4–19 in) or you could need to move to a different area to change the lighting and background. Verify the sticker is in the proper location. See **Applying the Trailer Reverse Aid Sticker** (page 405). You can move to a different area or change the direction you are driving or setup the system at a different time of day. Some trailers are not compatible with the sticker and camera system. If the issue persists with the sticker setup, you may choose to setup the trailer with a sensor.

What does it mean if the system pauses during calibration?

There could be steering input or trailer movement during the straight drive portion of the calibration process.

What does it mean if the system remains on one message for an extended time during calibration when setting up the system with the sensor?

The sensor could be incorrectly installed, the trailer length could be outside the allowed range or the road surface could be too rough or bumpy.

What does it mean if the system displays hold steering steady during turn?

Part of the calibration process for the sticker setup requires a steady turn. If you are continually moving the steering wheel during the turn, this delays the calibration process. To enable the calibration process, hold the steering wheel at the same position when turning.

Trailer Reverse Guidance (If Equipped)

What does it mean if the system displays that it is not available?

There could be a sub-system that the system uses that is not correctly operating or there could be a battery voltage issue. If the system continues to display it is not available, visit your authorized dealer to have your vehicle checked.

What does it mean if the system displays that driving is required to initialize steering?

The steering system needs to learn internal parameters to fully turn on the feature. Drive your vehicle straight forward above 40 km/h (25 mph) for approximately 5 minutes. This could also occur when your vehicle is new, there is a battery voltage issue or if the steering system has been serviced.

What does it mean if the system does not detect a trailer when configured with a sensor?

Verify that the sensor is properly connected. See **Trailer Sensor Installation** (page 405). Repeat calibration on a different route if you have verified sensor installation.

What does it mean if the system requires you to pull forward to initialize?

This occurs when the vehicle has not moved during the current key cycle after you connect and select the trailer in the touchscreen or you operate the system at speeds below 1 km/h (1 mph) for an extended period of time. Drive forward above 3 km/h (2 mph) and the system indicates when it initializes.

What does it mean if the trailer is at its maximum angle or the system deactivated by trailer angle?

You are at the maximum controllable trailer angle for the system. Place your vehicle in drive (D) and pull forward to get the truck and trailer back to an in-line position. If this message consistently displays, this could indicate the sensor is incorrectly installed, the trailer needs to be recalibrated or the drawbar or the trailer dimensions are outside of the supported range. The system is designed to work with drawbars that have a license plate to hitch ball center measurement of 23–46 cm (9–18 in) when installed. The system is designed to work with trailers that have a hitch point to center of the axle or axles measurement of 1.85–10.05 m (6–33 ft). Do not attempt to use drawbars or trailers that have a length outside of this range as the system performance degrades and could cause improper system function. Check that the correct trailer is selected in the touchscreen. Verify the sensor is installed according to the instructions included in the sensor kit and check that the drawbar and the trailer dimensions are within the allowed range. Then, delete the trailer from the system and repeat the setup process to calibrate the trailer.

Trailer Reverse Guidance (If Equipped)

What does it mean when the system tells you to take control of the steering wheel?

The system is no longer steering the vehicle and you must take over steering. There are four reasons the system could display this message. The first reason the system could display this message is that you have touched the steering wheel when the system is steering. The second reason the system could display this message is that you have exceeded the maximum speed for the feature. The third reason the system could display this message is that the trailer is not detected. The final reason the system could display this message is that an internal condition for system operation is not met that requires your vehicle to return to manual control of the steering.

How do I use a sticker if I have previously setup a trailer with the sensor?

Disconnect the sensor wiring and add a new trailer to the system and follow the instructions for setup with a sticker. See **Applying the Trailer Reverse Aid Sticker** (page 405). If your vehicle does not support the sticker option, the touchscreen instructs you to install the sensor again.

What if I want to use a sensor for the trailer instead of a sticker?

Install the sensor and connect the sensor wiring before adding the new trailer to the system. You must connect the sensor before you add the trailer. If your vehicle did not come with a sensor, you can purchase one from your authorized dealer.

What does it mean if the system does not detect a trailer that is setup with a sticker?

The system requires a clear view of the sticker placed on the trailer. You must keep the camera lens and sticker clean for the system to correctly operate. If the system cannot initially detect the trailer, it could be necessary for you to change the lighting conditions by moving your vehicle and trailer or waiting until the conditions change. See **Applying the Trailer Reverse Aid Sticker** (page 405). Some trailers are not compatible with the sticker and camera system. If the system consistently does not detect the trailer with the sticker setup, you may choose to setup the trailer with a sensor.

Note: *The system is designed to be used with the same trailer connection every time you choose the trailer from the touchscreen. When using a different drawbar or a different pin hole on drawbars with more than one, connecting the drawbar to your vehicle affects the trailer position and you may need to repeat the trailer setup and calibration process.*

Off-Road Driving

BASIC OFF-ROAD DRIVING TECHNIQUES

Off-road Driving Hints

Before taking your vehicle off-roading, perform a basic inspection to make sure your vehicle is in good working condition.

We recommend that you always use at least two vehicles while off-roading. The buddy system helps make sure that help is close at hand should a vehicle become stuck or damaged. It is also wise to take supplies such as a first aid kit, water, tow strap, cell phone with you.

The following are hints for safe off-road driving:

- Steer, brake and accelerate in a smooth controlled manner. Avoid jerky, unsteady movements.
- Look ahead on your route noting upcoming obstacles, or any other factors that may indicate a change in available traction and adjust the vehicle speed and route accordingly.
- If the front or rear suspension is bottoming out, or you encounter excessive contact with the skid-plates, reduce the vehicle speed to avoid potential damage to your vehicle.
- We recommend that you use vehicle communication, such as, turn signals, brake lights, and hazard flashers to alert other drivers of what you intend to do next, and of obstacles that could cause potential vehicle damage.

- Always keep available ground clearance in mind and pick a route that minimizes the risk of catching the underside of the vehicle on an obstacle.
- When negotiating low speed obstacles, applying light brake pressure in conjunction with the throttle helps prevent your vehicle from jerking and allows you to negotiate the obstacle in a more controlled manner. Using four-wheel drive low (4L) will also help with this.

Crossing Obstacles

- Review the path ahead before attempting to cross an obstacle. It is best if you view the obstacle from outside your vehicle so that you have a good understanding of terrain conditions both in front of and behind the obstacle.
- Approach obstacles slowly.
- If you cannot avoid a large obstacle such as a rock, choose a path that places the rock directly under the tire rather than the undercarriage of your vehicle. This helps prevent damage to your vehicle.
- Cross ditches and washouts at a 45° angle, allowing each wheel to independently cross the obstacle.

Climbing A Hill



WARNING: Extreme care should be used when steering the vehicle in reverse down a slope so as not to cause the vehicle to swerve out of control.

Do not drive over the crest of a hill without seeing what conditions are on the other side. Do not drive in reverse over a hill without the aid of an observer.

Off-Road Driving

- Always attempt to climb a steep hill along the fall line of the slope and not diagonally.
- If the vehicle is unable to make it up the hill, DO NOT attempt to turn back down the slope. Place the vehicle in low range and slowly back down in reverse.
- When descending a steep slope, select low gear and engage hill descent control. Use the accelerator and brake pedals to control your descent speed.

Note: Hill descent control is functional in reverse and should be used in this situation.

Note: Avoid turning on steep slopes or hills. You could lose traction, slip sideways or a possible vehicle roll over.

Driving Over Rocks and Gravel

Never attempt to straddle a rock that is large enough to strike your axles or undercarriage. Leave a generous gap between your vehicle and other vehicles to minimize the risk of damage. Avoid dust clouds as they reduce visibility.

DRIVING THROUGH WATER LIMITATIONS



WARNING: Do not attempt to cross a deep, fast flowing body of water. Failure to follow this instruction could result in the loss of control of your vehicle, personal injury or death.

Determine the depth and speed of the current before attempting a water crossing. As the water depth increases, reduce your vehicle speed to avoid potential vehicle damage.

The key to a safe crossing is the water depth, current and bottom of the water's condition. On soft bottoms, the vehicle sinks in, effectively increasing the water level on the vehicle. Make sure to consider this when determining the depth of water. Be aware that obstacles and debris may be beneath the water's surface.

Note: Cross flowing water at an angle heading slightly upstream.

Note: Tread lightly and avoid damage to the environment.

Drive slowly when crossing water. Start very slowly when entering, then build momentum. Proceed with a constant slow speed lightly pressing on the accelerator. Ease off the accelerator as you reach the other side to diminish the front wave. Apply the accelerator slowly and as necessary to climb out of the other side

Note: Do not try to accelerate through the water crossing.

When driving too fast in water or through deep water, the engine, transmission, transfer case, axles, electrical components or vehicle interior could ingest water. Muddy waters can reduce the cooling system effectiveness by depositing debris into the radiator. The vehicle warranty does not cover water damage. See below for your vehicle's capabilities.

Model	Maximum Wading Capability
Vehicles without Tremor or XL Off-Road Packages	560 mm (22 in) ¹
XL Off-Road Package	762 mm (30 in)
Tremor Package	838 mm (33 in)

¹ Bottom of the doors.

Off-Road Driving

Note: When you are driving through water do not exceed 7 km/h (4 mph)

Never stop or shut a vehicle off when crossing deep water unless your vehicle ingested water into the engine air intake. If the engine stalls, do not attempt to restart it. Keep the doors fully closed during a water crossing. Take extra care crossing any type of water. Do not drive into water unless necessary. Only drive through areas that are designated and approved. Determine exit points that are downstream of your entry point to allow for drifting. If there are other vehicles ahead, wait until they have left the water. Unsettled water can make a safe passage more challenging.

High currents even in shallow water can wash the dirt out from around your tires or push your vehicle across slippery rocks or surfaces. Never attempt to cross flowing water that is deeper than your vehicle's ground clearance. Even in low currents your vehicle's body surface area can be pushed downstream and out of control. Do not cross any body of water that is fast flowing and rising, wait for the flow rate to reduce.

Vehicles used to cross water regularly should be periodically inspected for signs of water ingestion in all of the vehicle's fluids. If water is found inside your vehicle fluids, service your vehicle or see an authorized dealer.

After driving through water and as soon as it is safe to do so, check the brakes, horn, lights, and steering wheel to make sure everything is still in working order.

AFTER DRIVING YOUR VEHICLE OFF-ROAD



WARNING: After off-road use, before returning to the road, check the wheels and tires for damage. Off-road use may cause damage to your wheels and tires that can lead to tire failure, loss of vehicle control, serious injury or death.



WARNING: Always re-inflate tires to recommended tire pressures before the vehicle is operated on-road. The recommended pressure is located on the tire label or safety certification label, located on the B-pillar, inside the driver's door.

After driving off-road check for damage to your vehicle and, if necessary, have your vehicle fixed as soon as possible. Inspect the underbody of your vehicle by checking tires, body structure, steering, suspension, and exhaust system for damage.

Check the radiator for mud and debris and clean as needed.

Remove accumulations of plants or brush. These things could be a fire hazard or hide damage to the fuel lines, brake hoses, and propeller shafts.

With the vehicle off, use a low pressure hose to wash away mud and fine debris. You may need to reach past the active grille shutters to remove larger debris.

If you experience unusual vibration after driving in mud, slush or similar conditions, check the wheels for impacted material. Impacted material can cause vibrations while driving and wheel imbalance. Remove the material to resolve the problem.

Driving Hints

COLD WEATHER PRECAUTIONS - 6.7L DIESEL

Winter Grill Cover (If Equipped)

The winter grill cover enhances heater performance and will reduce the amount of time it takes to warm the inside of your vehicle in extremely cold conditions below -18°C (-0.4°F).

The winter grill cover installs over the outside of the front grill and restricts the air flowing to the engine compartment by covering the radiator grill openings.



Note: The grill cover must be installed in extremely cold conditions below -12°C (10.4°F) to prevent possible engine damage.

Usage Guidelines

The winter grill cover should only be used while operating your vehicle in extremely cold temperatures or in heavy snow for extended periods of time. In these temperatures, the vehicle does not need a large amount of air to properly cool the engine. During periods of operation when more airflow is required to cool the vehicle, the winter grill cover should not be used.

The following usage guidelines will allow adequate airflow for proper radiator and air cooler performance:

- Do not use the cover when temperatures are above 10°C (50.0°F). Use of the cover in these conditions could cause your vehicle to overheat. Remove the cover if the vehicle overheats.
- Do not use the cover above 0°C (32.0°F) if towing a trailer. Your vehicle may overheat if the cover is used while towing a trailer.
- Do not modify the cover.

Installation Instructions

Installation and removal instructions are included in the winter grill cover package. Refer to the usage guidelines to understand when to use the cover.

The cover will seem undersized during the first installation, which is normal. The cover stretches during installation to ensure a tight fit. The first installation is best performed when the grill cover is warm.

COLD WEATHER PRECAUTIONS - 6.8L/7.3L

The functional operation of some components and systems can be affected at temperatures below approximately -25°C (-13°F).

DRIVING ON SNOW AND ICE



WARNING: If you are driving in slippery conditions that require tire chains or cables, then it is critical that you drive cautiously. Keep speeds down, allow for longer stopping distances and avoid aggressive steering to reduce the

Driving Hints

chances of a loss of vehicle control which can lead to serious injury or death. If the rear end of your vehicle slides while cornering, steer in the direction of the slide until you regain control of your vehicle.

On ice and snow, you should drive more slowly than usual. Your vehicle has an anti-lock braking system, apply the brake pedal steadily. Do not pump the brake pedal. See **Anti-Lock Braking System Limitations** (page 251).

BREAKING-IN

Your vehicle requires a break-in period. For the first 1,600 km (1,000 mi), avoid driving at high speeds, heavy braking, aggressive shifting or using your vehicle to tow. During this time, your vehicle may exhibit some unusual driving characteristics.

DRIVING ECONOMICALLY

The following helps to improve fuel consumption:

- Drive smoothly, accelerate gently and anticipate the road ahead to avoid heavy braking.
- Regularly check your tire pressures and make sure that they are inflated to the correct pressure.
- Follow the recommended maintenance schedule and carry out the recommended checks.
- Plan your journey and check the traffic before you set off. It is more efficient to combine errands into a single trip whenever possible.
- Avoid idling the engine in cold weather or for extended periods. Start the engine only when you are ready to set off.

- Do not carry unnecessary weight in your vehicle as extra weight wastes fuel.
- Do not add unnecessary accessories to the exterior of your vehicle, for example running boards. If you use a roof rack, remember to fold it down or remove it when not in use.
- Do not shift into neutral when you are braking or when your vehicle is slowing down.
- Shut all windows when driving at high speeds.
- Switch off all electric systems when not in use, for example air conditioning. Make sure that you unplug any accessories from the auxiliary power points when not in use.

DRIVING THROUGH MUD AND WATER



WARNING: Do not spin the wheels at over 55 km/h (34 mph). The tires may fail and injure a passenger or bystander.

Mud

Be cautious of sudden changes in vehicle speed or direction when you are driving in mud. Even all-wheel drive and four-wheel drive vehicles can lose traction in mud. If your vehicle slides, steer in the direction of the slide until you regain control of your vehicle. After driving through mud, clean off residue stuck to rotating driveshafts and tires. Excess residue can cause an imbalance that could damage drive components.

Note: *If your vehicle gets stuck in mud, it could be rocked out by shifting between forward and reverse gears, stopping between shifts in a steady pattern. Press lightly on the accelerator in each gear.*

Driving Hints

Water

If you must drive through water approach it cautiously. See **Driving Through Water Limitations** (page 415).

FLOOR MATS



WARNING: Use a floor mat designed to fit the footwell of your vehicle that does not obstruct the pedal area. Failure to follow this instruction could result in the loss of control of your vehicle, personal injury or death.



WARNING: Pedals that cannot move freely can cause loss of vehicle control and increase the risk of serious personal injury.



WARNING: Secure the floor mat to both retention devices so that it cannot slip out of position and interfere with the pedals. Failure to follow this instruction could result in the loss of control of your vehicle, personal injury or death.



WARNING: Do not place additional floor mats or any other covering on top of the original floor mats. This could result in the floor mat interfering with the operation of the pedals. Failure to follow this instruction could result in the loss of control of your vehicle, personal injury or death.



WARNING: Always make sure that objects cannot fall into the driver foot well while your vehicle is moving. Objects that are loose can become trapped under the pedals causing a loss of vehicle control.



To install floor mats that have eyelets, position the floor mat eyelet over the retention post and press down to lock in position. Repeat for all eyelets on the floor mat.

To remove the floor mats, reverse the installation procedure.

Note: *Regularly check the floor mats to make sure they are secure.*

Snow Plowing (If Equipped)

SNOW PLOWING PRECAUTIONS



WARNING: Modifying or adding equipment to the front of your vehicle could affect the performance of the airbag system, increasing the risk of injury. This includes the hood, bumper system, frame, front body structure, tow hooks, hood pins, push bar and snowplows.



WARNING: Do not attempt to service, repair, or modify the supplementary restraint system or associated components. Failure to follow this instruction could result in personal injury or death.



WARNING: All occupants of your vehicle, including the driver, should always properly wear their seatbelts, even when an airbag supplemental restraint system is provided. Failure to properly wear your seatbelt could seriously increase the risk of injury or death.



WARNING: Do not spin the wheels at over 55 km/h (34 mph). The tires may fail and injure a passenger or bystander.

Note: Look for an alterer's label on your vehicle from the snowplow installer certifying that the installation meets all applicable Federal Motor Vehicle Safety Standards (FMVSS).

Note: Federal and some local regulations require additional exterior lamps for snowplow-equipped vehicles. Contact an authorized dealer for additional information.

Note: Do not remove or defeat the tripping mechanisms designed into the snow removal equipment by its manufacturer. Doing so could cause damage to your vehicle and the snow removal equipment as well as possible airbag deployment.

OPERATING YOUR VEHICLE WITH A SNOWPLOW

Weight limits and guidelines for selecting and installing the snowplow are in the Ford Truck Body Builders Layout Book. For additional information, visit www.fordbbas.com.

A typical snowplow installation affects the following:

- Front gross axle weight rating. See **What Is the Gross Axle Weight Rating** (page 352).
- Gross vehicle weight rating. See **What Is the Gross Vehicle Weight Rating** (page 353).
- Braking and steering.
- Front wheel toe. See the **Ford Workshop Manual**.
- Headlight aim. See **Adjusting the Headlamps** (page 473).
- Tire air pressure. See **Information on the Tire Sidewall** (page 499).

Note: Do not exceed the front gross axle weight rating or gross vehicle weight rating.

Note: Your vehicle may require rear ballast weight for proper braking and steering.

Your vehicle has a driver and passenger airbag supplemental restraint system. The supplemental restraint system activates in certain frontal and offset frontal collisions when the vehicle sustains sufficient longitudinal deceleration.

Snow Plowing (If Equipped)

When operating your vehicle with a snowplow:

- Do not exceed 72 km/h (45 mph).
- Your engine could run at a higher temperature than normal.
 - If you are driving more than 24 km (15 mi) at temperatures above freezing, angle the plow blade either full left or full right to provide maximum airflow to the radiator.
 - If you are driving less than 24 km (15 mi) at speeds up to 72 km/h (45 mph) in cold weather, you do not need to worry about blade position to provide maximum airflow.
- Shift to **4L** when plowing in small areas at speeds below 8 km/h (5 mph).
- Shift to **4H** when plowing larger areas or light snow at higher speeds above 8 km/h (5 mph). Do not exceed 24 km/h (15 mph).
- Do not shift the transmission from a forward gear to reverse (R) until the engine is at idle and the wheels have stopped.

Note: Careless or high-speed driving when snowplowing, which results in significant vehicle decelerations, can deploy the airbag. Such driving also increases the risk of accidents.

Note: Drive your vehicle at least 800 km (500 mi) before using your vehicle for snowplowing.

Note: Follow the severe duty schedule for engine oil and transmission fluid change intervals. See **General Maintenance Information** (page 589).

SNOWPLOW MODE - VEHICLES WITH: SNOW PLOW MODE

WHAT IS SNOWPLOW MODE

Snowplow mode reduces vehicle electrical load to allow the electrical system to have sufficient power to support residential snowplow use.

SWITCHING SNOWPLOW MODE ON AND OFF

Vehicles are available with a button in the instrument panel or an option in the center display to enable snowplow mode.

Snowplow mode does not remember the setting when you switch your vehicle off. You must re-enable the mode every time you wish to use it.

The following features turn off and are disabled in snowplow mode and cannot be turned back on until snowplow mode is switched off:

- 120 V inverter.
- Fog lamps.
- Heated and ventilated front seats.

The body control module also activates the snowplow relay that provides power to aftermarket snowplow controls.

Note: The electrical system supports the addition of a residential snowplow of up to 60 A continuous, and snowplow lights of up to 20 A continuous using snowplow mode. The system does not support snowplow usage with additional electrical aftermarket accessories.

Snow Plowing (If Equipped)

Using the Instrument Panel (If Equipped)

Press the snowplow button on the instrument panel to switch on snowplow mode. The snowplow button illuminates and a message displays.

Press the snowplow button or switch off the vehicle to switch off snowplow mode.

Using the Center Display Screen (If Equipped)

1. From the features menu, press Snow Plow Mode. See **Center Display** (page 558).
2. Switch Snow Plow Mode on or off.

Crash and Breakdown Information

ROADSIDE ASSISTANCE

Vehicles Sold in the United States: Getting Roadside Assistance

If you have a vehicle concern, Ford Motor Company offers a complimentary roadside assistance program. This program is separate from the New Vehicle Limited Warranty.

The service is available:

- 24 hours a day, seven days a week.
- For the coverage period supplied with your vehicle.

Knowing your vehicle's VIN, mileage and your specific location allows help to get to you faster.

Roadside Assistance covers:

- A flat tire change with a good spare (except vehicles supplied with a tire inflation kit).
- Battery jump start.
- Lock-out assistance (key replacement cost is the customer's responsibility).
- Fuel delivery — independent service contractors, if not prohibited by state, local or municipal law, shall deliver up to 8 L (2 gal) of gasoline or 20 L (5 gal) of diesel fuel to a disabled vehicle. Roadside assistance limits fuel delivery service to two no-charge occurrences within a 12-month period.
- Winch out — available within 30 m (100 ft) of a paved or county maintained road, no recoveries.

- Towing — independent service contractors, if not prohibited by state, local or municipal law, shall tow Ford eligible vehicles to an authorized dealer within 80 km (50 mi) of the disablement location or to the nearest authorized dealer. If a member requests a tow to an authorized dealer that is more than 80 km (50 mi) from the disablement location, the member shall be responsible for any mileage costs in excess of 80 km (50 mi). Warranty towing, non-warranty towing and collision towing are available.
- Roadside Assistance includes up to \$200 for a towed trailer if the disabled eligible vehicle requires service at the nearest authorized dealer. If the towing vehicle is operational but the trailer is not, then the trailer does not qualify for any roadside services.

Vehicles Sold in the United States: Using Roadside Assistance

United States vehicle customers who require Roadside Assistance, call 1-800-241-3673.

If you need to arrange roadside assistance on your own, Ford Motor Company reimburses a reasonable amount for towing to the nearest dealership within 80 km (50 mi). To obtain reimbursement information, United States vehicle customers call 1-800-241-3673. Customers need to submit their original receipts.

Vehicles Sold in Canada: Getting Roadside Assistance

If you have a vehicle concern, Ford Motor Company of Canada, Limited offers a complimentary roadside assistance program. This program is eligible within Canada or the continental United States.

The service is available 24 hours a day, seven days a week.

Crash and Breakdown Information

This program is separate from the New Vehicle Limited Warranty, but the coverage is concurrent with the powertrain coverage period of your vehicle. Canadian roadside coverage and benefits may differ from the U.S. coverage. For complete details, see your Warranty Guide at www.ford.com/support/warranty/.

Download the Sykes4Ford Roadside Assistance App for access to your roadside assistance services. For more information, scan here:



If you require more information, please call us in Canada at 1-800-665-2006, or visit our website at www.ford.ca.

Ford Motor Company reserves the right to modify or discontinue Roadside Assistance at any time. Certain restrictions apply to Roadside Assistance benefits.

For further details, call
1-800-665-2006 (Canada)
1-800-241-3673 (United States)

SWITCHING THE HAZARD FLASHERS ON AND OFF



The hazard flasher button is on the instrument panel. Press the button to switch the hazard flashers on if your vehicle is creating a safety hazard for other road users.

When you switch the hazard flashers on, all front and rear direction indicators flash.

Note: *The hazard flashers operate when the ignition is in any position, or if the key is not in the ignition. The battery loses charge and could have insufficient power to restart your vehicle.*

Press the button again to switch them off.

JUMP STARTING THE VEHICLE

JUMP STARTING PRECAUTIONS



WARNING: Batteries normally produce explosive gases which can cause personal injury. Therefore, do not allow flames, sparks or lighted substances to come near the battery. When working near the battery, always shield your face and protect your eyes. Always provide correct ventilation.



WARNING: Keep batteries out of reach of children. Batteries contain sulfuric acid. Avoid contact with skin, eyes or clothing. Shield your eyes when working near the battery to protect against possible splashing of acid solution. In case of acid contact with skin or eyes, flush immediately with water for a minimum of 15 minutes and get prompt medical attention. If acid is swallowed, call a physician immediately.



WARNING: Use only adequately sized cables with insulated clamps.





WARNING: Make sure that the cables are clear of any moving parts and fuel delivery system parts.





WARNING: Connect batteries with only the same nominal voltage.

Crash and Breakdown Information

 **WARNING:** Using the jump leads incorrectly or completing the jump start procedure incorrectly can cause the battery to explode, which can lead to severe injuries.

 **WARNING:** All work on the vehicle battery and the electrical system can cause serious chemical burns, fire or electric shocks. Always read the warnings and safety information before carrying out any kind of work on the battery.

 **WARNING:** Never charge a 12-volt vehicle battery once it has been frozen. Discharged 12-volt vehicle batteries can even freeze at temperatures of approximately 0°C (+32°F).

 **WARNING:** The battery should be replaced if it is or has ever been frozen.

 **WARNING:** A highly explosive mixture of gases is given off when the vehicle battery is jump started. Always keep fire, sparks, naked flames and lit cigarettes away from the vehicle battery. Never use a mobile telephone when the jump leads are being connected or disconnected.

 **WARNING:** Only charge the battery in a well-ventilated space as the battery emits a highly explosive mixture of gases when the vehicle is being jump started.

 **WARNING:** Never confuse the negative and positive terminals or connect the jump leads incorrectly.

 **WARNING:** Observe the jump lead manufacturer's instructions.

 **WARNING:** If the engine is running while the hood is open, stay clear of moving engine components. Failure to follow this warning could result in serious personal injury or death.

Do not attempt to push-start an automatic transmission vehicle. This could cause transmission damage.

Do not disconnect the battery of the disabled vehicle. This could damage your vehicle's electrical system.

PREPARING THE VEHICLE

Use only a 12 volt supply to start your vehicle.

Park the booster vehicle close to the hood of the disabled vehicle, making sure the two vehicles do not touch.

JUMP STARTING THE VEHICLE

Connecting the Jumper Cables

 **WARNING:** Do not connect the negative jumper cable to any other part of your vehicle. Use the ground point.

Note: *If you are using a jump pack or booster box, follow the manufacturer's instructions.*

Crash and Breakdown Information

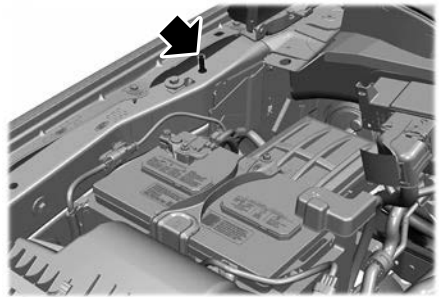
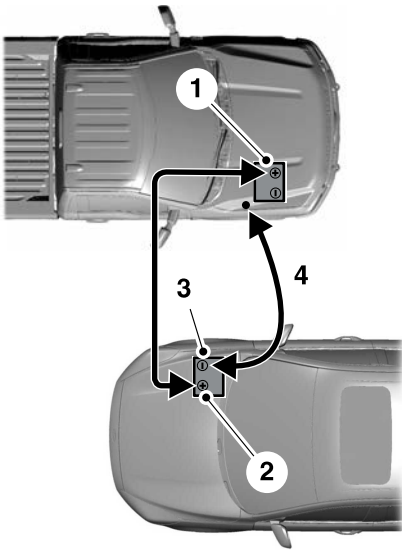

Starting the Engine

1. Start the engine of the booster vehicle and moderately rev the engine, or gently press the accelerator to keep the engine speed between 2000 RPM and 3000 RPM, as shown in your tachometer.
2. Start the engine of the disabled vehicle.
3. Once you start the disabled vehicle, run both vehicle engines for an additional three minutes before disconnecting the jumper cables.

Removing the Jumper Cables

Remove the jumper cables in the reverse order that they were connected.

Note: Do not switch the headlamps on when disconnecting the cables. The peak voltage could blow the bulbs.

POST-CRASH ALERT SYSTEM

WHAT IS THE POST-CRASH ALERT SYSTEM

The system helps draw attention to your vehicle in the event of a serious impact.

1. Pull the red rubber boot backward. Connect the positive (+) jumper cable to the positive (+) terminal of the discharged battery.
2. Connect the other end of the positive (+) jumper cable to the positive (+) terminal of the booster vehicle battery.
3. Connect the negative (-) jumper cable to the negative (-) terminal of the booster vehicle battery.
4. Make the final connection of the negative (-) jumper cable to the jump start stud as shown in the following illustration.

Note: Do not use the hood latch as a negative (-) connection point. This could cause springs in the latch to burn and prevent the hood from operating correctly.

Crash and Breakdown Information

HOW DOES THE POST-CRASH ALERT SYSTEM WORK

The system is designed to turn the hazard flashers on, turn the courtesy lamps on, intermittently sound the horn and unlock all doors in the event of a serious impact that deploys an airbag or the seatbelt pretensioners.

POST-CRASH ALERT SYSTEM LIMITATIONS

Depending on applicable laws in the country your vehicle was built for, the horn does not sound in the event of a serious impact.

SWITCHING THE POST-CRASH ALERT SYSTEM OFF

Press the hazard flasher switch, the unlock button on the remote control, the panic button on the remote control or cycle the ignition to switch the system off.

Note: *The alert turns off when the vehicle battery runs out of charge.*

POST-COLLISION BRAKING

How Does Post-Collision Braking Work

In the event of a moderate to severe crash, the braking system reduces the vehicle's speed to prevent or reduce the impact of a potential secondary crash.

Post-Collision Braking Limitations

Post-collision braking does not activate if any of the following occur:

- The anti-lock braking system is damaged during the collision.
- Electronic stability control is disabled.

Overriding Post-Collision Braking

You can override post-collision braking by pressing the brake or accelerator pedal.

Post-Collision Braking Indicators



It flashes when a post-collision braking event is occurring.

AUTOMATIC CRASH SHUTOFF

WHAT IS AUTOMATIC CRASH SHUTOFF

The automatic crash shutoff is designed to stop the fuel going to the engine in the event of a moderate or severe crash.

Note: *Not every impact causes a shutoff.*

AUTOMATIC CRASH SHUTOFF PRECAUTIONS



WARNING: If your vehicle has been involved in a crash, have the fuel system checked. Failure to follow this instruction could result in fire, personal injury or death.

RE-ENABLING YOUR VEHICLE

1. Switch the ignition off.
2. Attempt to start your vehicle.
3. Switch the ignition off.
4. Attempt to start your vehicle.

Note: *If your vehicle does not start after the third attempt, have your vehicle checked as soon as possible.*

Crash and Breakdown Information

RECOVERY TOWING

ACCESSING THE FRONT TOWING POINT



WARNING: Using recovery hooks is dangerous and should only be done by a person familiar with proper vehicle recovery safety practices. Improper use of recovery hooks may cause hook failure or separation from the vehicle and could result in serious injury or death.



WARNING: Slowly remove the slack from the recovery strap prior to pulling. Failure to do so can introduce significantly higher loads which can cause the recovery hooks to break off, or the recovery strap to fail which can cause serious injury or death.



WARNING: Never link two straps together with a clevis pin. These heavy metal objects could become projectiles if the strap breaks and can cause serious injury or death.



WARNING: Switch the ignition off before removing the recovery hook. Failure to do so could result in personal injury.



WARNING: The recovery hook can become hot. Let the recovery hook cool down before removing it. Failure to do so could result in personal injury.

Your vehicle has frame-mounted front recovery hooks.

Note: Do not apply a load to the recovery hooks that is greater than the gross vehicle weight rating of your vehicle.

Before using recovery hooks:

- Make sure all attaching points are secure and capable of withstanding the applied load.
- Do not use chains, cables or tow straps with metal hook ends.
- Only use recovery straps that have a minimum breaking strength two to three times the gross vehicle weight of the stuck vehicle.
- Make sure the recovery strap is in good condition and free of visible cuts, tears or damage.
- Use a damper device such as a tarp, heavy blanket or piece of carpet, and place it over the recovery strap to help absorb the energy in the event the strap breaks.
- Make sure the stuck vehicle is not loaded heavier than its gross vehicle weight rating specified on the certification label.
- Align the tow vehicle and stuck vehicle in a straight line, within 10 degrees.
- Keep bystanders to the sides of the vehicle, at a distance of at least twice the length of the recovery strap. This helps avoid injury from the hazard of a recovery hook or strap breaking, or a vehicle lurching into their path.

Note: Use towing equipment that is properly rated for your vehicle. Always carefully follow the instructions and warnings provided by the equipment manufacturer.

Crash and Breakdown Information

TRANSPORTING THE VEHICLE

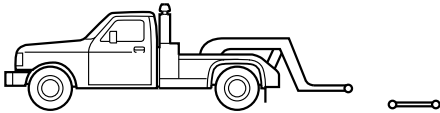

All-wheel or four-wheel drive vehicles require that all wheels be off the ground using a wheel lift and dollies or flatbed equipment. This prevents damage to the transmission and drive system.

Note: You need to switch on the ignition to unlock the steering.

Note: Make sure you check the steering column before towing. It could lock if the battery is dead.

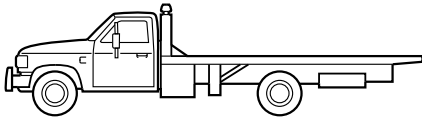

FAIL-SAFE COOLING

WHAT IS FAIL-SAFE COOLING

Fail-safe cooling allows you to temporarily drive your vehicle before any incremental component damage occurs due to overheating.

The fail-safe distance depends on outside temperature, vehicle load and terrain.

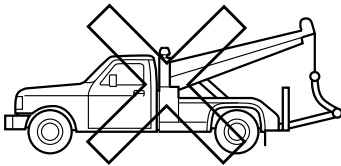

HOW DOES FAIL-SAFE COOLING WORK

If the engine reaches a preset over-temperature condition, the engine automatically switches to alternating cylinder operation. Each disabled cylinder acts as an air pump and cools the engine.

When this occurs, your vehicle still operates, however:

- Engine power is limited.
- The air conditioning system turns off.

Continued operation increases the engine temperature, causing the engine to completely shut down. Your steering and braking effort increases in this situation.

When the engine temperature cools, you can re-start the engine.

Note: Have your vehicle checked as soon as possible to minimize engine damage.

If you need to tow your vehicle, contact a professional towing service or your roadside assistance service provider.

Your manufacturer produces a towing manual for all authorized tow truck operators. Have your tow truck operator refer to this manual for proper hook-up and towing procedures.

We recommend the use of a wheel lift and dollies or flatbed equipment to tow your vehicle. Vehicle damage could occur if towed incorrectly, or by any other means.

Front-wheel and rear-wheel drive vehicles must have their designated drive wheels off the ground regardless of towing direction. Use tow dollies to prevent damage to the transmission.

Crash and Breakdown Information

DRIVING WHEN FAIL-SAFE MODE IS ACTIVATED



WARNING: Fail-safe mode is for use during emergencies only. Operate your vehicle in fail-safe mode only as long as necessary to bring your vehicle to rest in a safe location and seek immediate repairs. When in fail-safe mode, your vehicle will have limited power, will not be able to maintain high-speed operation, and may completely shut down without warning, potentially losing engine power, power steering assist, and power brake assist, which may increase the possibility of a crash resulting in serious injury.



WARNING: Do not remove the coolant reservoir cap when the engine is on or the cooling system is hot. Wait 10 minutes for the cooling system to cool down. Cover the coolant reservoir cap with a thick cloth to prevent the possibility of scalding and slowly remove the cap. Failure to follow this instruction could result in personal injury.

Continued operation increases the engine temperature, causing the engine to completely shut down. Your steering and braking effort increases in this situation.

When the engine temperature cools, you can re-start the engine. Have your vehicle checked as soon as possible to minimize engine damage.

Your vehicle has limited engine power when in the fail-safe mode, drive your vehicle with caution. Your vehicle does not maintain high-speed operation and the engine may operate poorly.

Remember that the engine is capable of automatically shutting down to prevent engine damage. In this situation:

1. Pull off the road as soon as safely possible and switch the engine off.
2. If you are a member of a roadside assistance program, we recommend that you contact your roadside assistance service provider.
3. If this is not possible, wait for a short period of time for the engine to cool.
4. Check the coolant level. If the coolant level is at or below the minimum mark, add prediluted coolant immediately.
5. When the engine temperature cools, you can re-start the engine. Have your vehicle checked as soon as possible to minimize engine damage.

Note: *Driving your vehicle without repair increases the chance of engine damage.*

FAIL-SAFE COOLING INDICATORS



If the engine begins to overheat, the coolant temperature gauge moves toward the red zone.



A warning lamp illuminates and a message may appear in the instrument cluster display.

Towing Your Vehicle

TOWING YOUR VEHICLE PRECAUTIONS

Use the following guidelines when towing your vehicle. Failure to follow this instruction could result in vehicle damage not covered by the vehicle warranty.

Note: Make sure you properly secure your vehicle to the tow vehicle.

Note: If you are unsure of the vehicle's configuration, contact an authorized dealer.

RECREATIONALLY TOWING YOUR VEHICLE - 4X4



WARNING: Do not disconnect the battery when recreationally towing your vehicle. This prevents the transfer case from shifting properly and could cause the vehicle to roll, even if the transmission is in park (P).



WARNING: Placing the transfer case in its neutral position could cause your vehicle to freely roll. Make sure you press and hold the brake pedal and the vehicle is in a secure, safe position when you place the transfer case in its neutral position.



WARNING: Switch your vehicle off to avoid draining the battery. Battery drainage can cause your vehicle to shift out of neutral tow mode. Failure to follow this instruction could result in fire, personal injury or property damage.

Follow these guidelines if you have a need for recreational towing. An example of recreational towing would be towing your vehicle behind a motorhome. These guidelines are to make sure that you do not damage the transmission.

You can only tow your vehicle with all wheels on the ground by placing the transfer case in its neutral position and engaging the neutral tow feature. Perform the following steps after positioning your vehicle behind the tow vehicle and properly securing them together.

Note: Put your climate control system in recirculated air mode to prevent exhaust fumes from entering your vehicle.

Note: Failure to put the transfer case in its neutral position can damage vehicle components.

Note: You can check the towing status at any time by opening the driver door or turning the ignition to the accessory or on position. **Neutral Tow Enabled Leave Transmission in Neutral** appears in the instrument cluster display to confirm you can recreationally tow your vehicle.

Note: If your vehicle has an anti-theft alarm, make sure you switch perimeter sensing off when towing. See **What Is the Perimeter Alarm** (page 96).

Switching Neutral Tow On

1. Place your vehicle in accessory mode by pressing the push button ignition switch once without pressing the brake pedal or by turning the ignition key to the on position.
2. Press and hold the brake pedal.
3. Press the **2H** button on the four-wheel drive mode control.
4. Shift the transmission into neutral (N).
5. Using the instrument cluster controls on the steering wheel, select **Settings**.
6. Select **Neutral Tow**.
7. Press and hold the **OK** button until a confirmation message appears in the instrument cluster display.

Towing Your Vehicle

Note: If completed successfully, the instrument cluster display shows **Neutral Tow Enabled Leave Transmission in Neutral**. This indicates that your vehicle is safe to tow with all wheels on the ground.

Note: If you do not see a confirmation message in the instrument cluster display, you must perform the procedure again from the beginning.

Note: You may hear noise as the transfer case shifts into its neutral position. This is normal.

8. Release the brake pedal and leave the transmission in neutral (N) and switch your vehicle off by pressing the push button ignition switch once without pressing the brake pedal or turning the key as far toward the off position as possible.

Note: Vehicles with keys, do not turn to the off position when the transmission is in neutral (N). You must leave the key in the ignition when towing. Make sure the key is as far toward the off position as possible. Use the keyless entry keypad or an extra set of keys to lock and unlock your vehicle.

Switching Neutral Tow Off

1. With your vehicle properly secured to the tow vehicle, place your vehicle in accessory mode by pressing the push button ignition switch once without pressing the brake pedal or by turning the ignition key to the on position.
2. Press and hold the brake pedal.
3. Shift the transmission to Park (P) and continue holding the brake pedal until the instrument cluster display shows 2H and Neutral Tow Disabled.
4. Release the brake pedal.

Note: If completed successfully, the instrument cluster displays **2H** and **Neutral Tow Disabled**.

Note: You must perform the switching neutral tow on and switching neutral tow off procedures again from the beginning if the indicator and message do not display.

Note: You may hear a noise as the transfer case shifts out of its neutral position. This is normal.

5. Apply the parking brake, then disconnect your vehicle from the tow vehicle.
6. Release the parking brake, start the engine, and shift into drive (D) to make sure the transfer case is out of the neutral tow position.
7. If the transfer case does not successfully shift out of its neutral position, set the parking brake. Have your vehicle checked as soon as possible.

Resolving the Shift Delayed Pull Forward Message

1. Press and hold the brake pedal.
2. Start your vehicle.
3. Shift into neutral (N).
4. With the vehicle running, shift into drive (D) and let the vehicle roll forward up to 1 m (3 ft).

Note: You may hear a noise as the transfer case shifts out of its neutral position. This is normal.

5. Make sure the instrument cluster displays **Neutral Tow Disabled**.

Towing Your Vehicle

RECREATIONALLY TOWING YOUR VEHICLE - 4X2

You cannot recreational tow your vehicle with all wheels on the ground because vehicle or transmission damage could occur. You must recreational tow your vehicle with all four wheels off the ground, such as when using a car-hauling trailer. Otherwise, you cannot recreational tow your vehicle.

EMERGENCY TOWING

If your vehicle becomes inoperable without access to wheel dollies or a vehicle transport trailer, it can be flat-towed with all wheels on the ground, regardless of the powertrain and transmission configuration, under the following conditions:

- Your vehicle is facing forward for towing in a forward direction.
- The transmission is in neutral (N).
- Maximum speed is 56 km/h (35 mph).
- Maximum distance is 80 km (50 mi).

TOWING YOUR VEHICLE – TROUBLESHOOTING

TOWING YOUR VEHICLE – INFORMATION MESSAGES

Message	Details
Neutral Tow Enabled Leave Transmission in Neutral	The transfer case is in the neutral position and your vehicle is safe to tow with all four wheels on the ground.
Shift Delayed Drive Forward	There is a transfer case gear tooth blockage present. With your vehicle on, shift the transmission into drive (D) and let the vehicle roll forward, up to 1 m (3 ft).
Neutral Tow Disabled	The transfer case is not in the neutral position and your vehicle is not safe to tow with all four wheels on the ground.

Fuses

FUSE PRECAUTIONS

⚠ WARNING: Always disconnect the battery before servicing high current fuses.

⚠ WARNING: To reduce risk of electrical shock, always replace the cover to the power distribution box before reconnecting the battery or refilling fluid reservoirs.

⚠ WARNING: Always replace a fuse with one that has the specified amperage rating. Using a fuse with a higher amperage rating can cause severe wire damage and could start a fire.

ACCESSING THE UNDER HOOD FUSE BOX

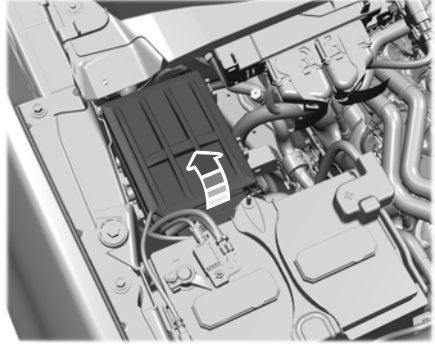

UNDER HOOD FUSE BOX

LOCATING THE UNDER HOOD FUSE BOX

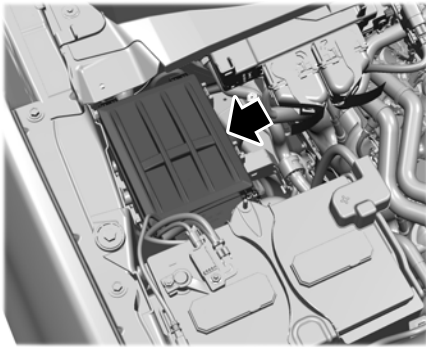

Fuses

IDENTIFYING THE FUSES IN THE UNDER HOOD FUSE BOX



Item	Rating	Protected Component
1	50 A	Cooling fan 1.
2	50 A	Heater.
3	50 A	Heater.
4	50 A	Heater.
9	30 A	Four-wheel drive module.
10	30 A	Compressed natural gas module switch.
12	60 A	Anti-lock brake system pump.
13	30 A	Passenger power seat.
14	40 A	Anti-lock brake system valve.

Fuses

Item	Rating	Protected Component
15	30 A	Body control module power bus.
21	10 A	Trailer tow backup lamps.
22	10 A	Four-wheel drive system.
23	20 A	Vehicle power 1.
24	20 A	Vehicle power 2 (gas).
	10 A	Vehicle power 2 (diesel).
25	15 A	Vehicle power 3 (gas).
	10 A	Vehicle power 3 (diesel).
26	20 A	Vehicle power 4.
27	10 A	Vehicle power 5 (gas).
	20 A	Vehicle power 5 (diesel).
29	15 A	Diesel exhaust fluid tank heater.
30	15 A	Diesel exhaust fluid line heater.
31	15 A	Glow plug and dosing module.
34	20 A	Rear heated seats.
36	30 A	Climate controlled seat module.
37	5 A	24 V alternator.
38	10 A	Powertrain control module. Transmission control module.
39	10 A	Anti-lock brake system.
40	10 A	Electronic power assist steering.
41	10 A	Blind spot information system.

Fuses

Item	Rating	Protected Component
		Trailer tow tire pressure monitoring system. Rear electronic module controller area network.
42	10 A	Snowplow.
43	15 A	Interior power distribution box run/start.
45	15 A	Heated steering wheel.
46	20 A	Not used (spare).
47	5 A	Not used (spare).
48	30 A	Amplifier.
49	25 A	Not used (spare).
51	40 A	Blower motor.
52	—	Not used.
53	10 A	Four-wheel drive - transfer case control module.
54	10 A	Not used (spare).
55	10 A	Not used (spare).
56	40 A	Electronic power assist steering.
57	20 A	Trailer tow lighting module.
58	50 A	Customer interface module.
59	60 A	Inverter.
60	60 A	Interior power distribution box B+.
61	30 A	Vehicle battery 2.
62	5 A	Smart trailer hitch.
63	10 A	Smart data link connector. Enhanced central gateway.
64	5 A	Glow plug relay coil (diesel).

Fuses

Item	Rating	Protected Component
65	10 A	Compressed natural gas module power.
74	30 A	Trailer brake control. Aftermarket e-brake access.
75	30 A	Compressed natural gas powered at all times.
76	25 A	Trailer tow lighting module battery charge.
77	30 A	Vehicle battery 1.
78	20 A	Power point 2.
79	20 A	Power point 1.
84	20 A	Horn.
85	40 A	Heated rear windshield.
91	5 A	Headlamp control module.
92	15 A	Left-hand headlamp.
93	15 A	Right-hand headlamp.
94	20 A	Power point 3.
95	20 A	Power point 4. Smart charge module.
98	10 A	Tailgate release.
101	50 A	Customer interface module.
102	5 A	Rain sensor.
103	30 A	Front wiper motor.
105	30 A	Fuel pump.
106	30 A	Body control module power bus.
107	30 A	Trailer tow park lamps.

Fuses

Item	Rating	Protected Component
108	40 A	Driver power seat.
109	30 A	Starter motor.
111	30 A	Power sliding rear window.

BATTERY FUSE BOX

LOCATING THE BATTERY FUSE BOX

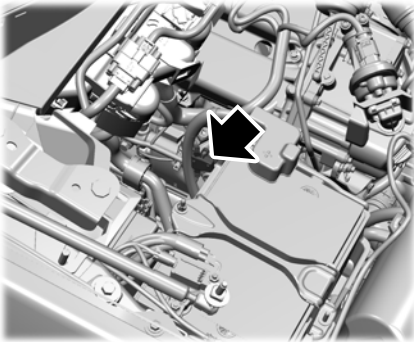

ACCESSING THE BATTERY FUSE BOX

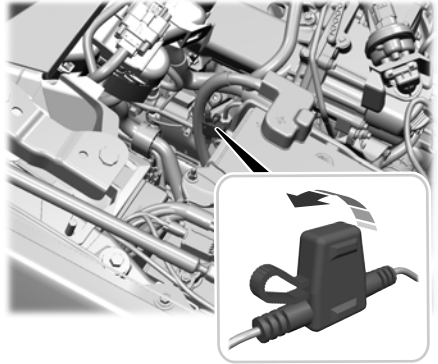

Fuses

IDENTIFYING THE FUSES IN THE BATTERY FUSE BOX

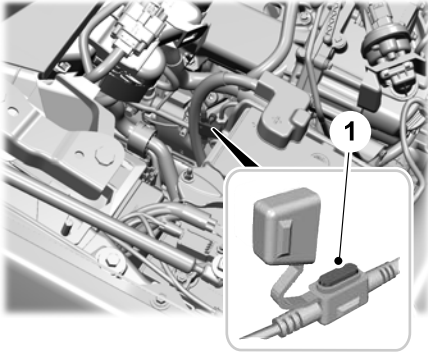

Item	Rating	Protected Component
1	3 A	Battery monitoring system.

ACCESSING THE INTERIOR FUSE BOX

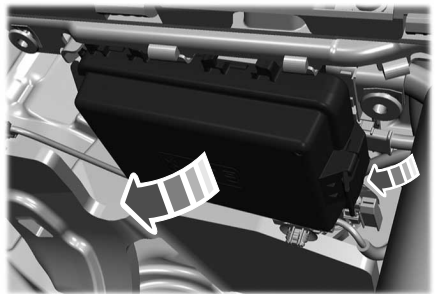
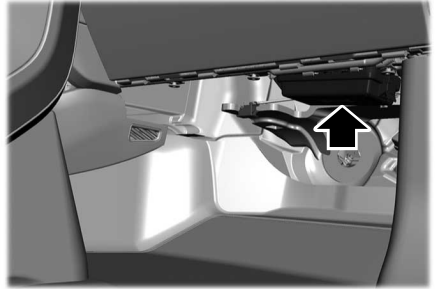

INTERIOR FUSE BOX

LOCATING THE INTERIOR FUSE BOX

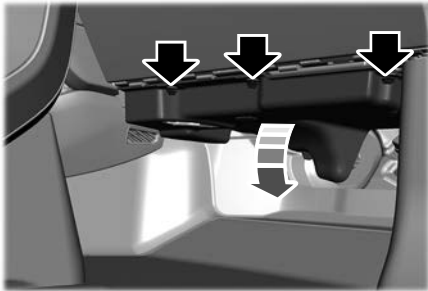

Fuses

IDENTIFYING THE FUSES IN THE INTERIOR FUSE BOX

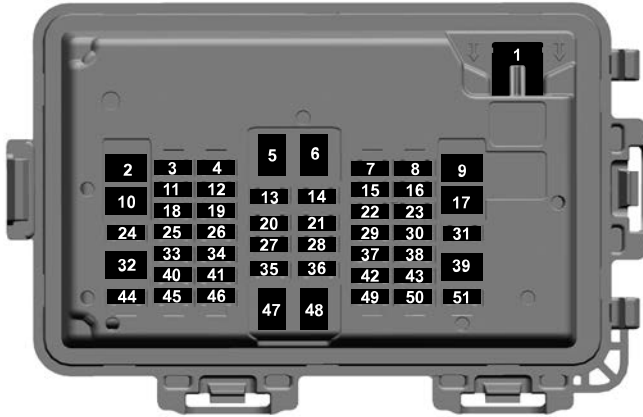

Item	Rating	Protected Component
1	30 A	Power windows.
2	30 A	Powered tailgate module.
3	30 A	Passenger door module.
4	15 A	Multi-contour seats.
5	—	Not used.
6	—	Not used.
7	20 A	Advanced driver assistance system module.
8	10 A	Delayed accessory logic.
9	—	Not used.
10	—	Not used.
11	5 A	Instrument cluster.
12	—	Not used.
13	7.5 A	Not used (spare).

Fuses

Item	Rating	Protected Component
14	15 A	SYNC.
15	5 A	Center high-mounted stop lamp camera.
16	—	Not used.
17	—	Not used.
18	10 A	Radio transceiver module. Four-wheel drive switch. Enhanced central gateway.
19	—	Not used.
20	5 A	Inverter.
21	5 A	Upfitter switch.
22	10 A	Auxiliary camera.
23	—	Not used.
24	30 A	Moonroof.
25	5 A	Not used (spare).
26	5 A	Not used (spare).
27	5 A	Trailer brake control switch.
28	5 A	Electrochromatic mirror.
29	5 A	Heating, ventilation and air conditioning.
30	—	Not used.
31	—	Not used.
32	—	Not used.
33	10 A	Brake on-off switch.
34	7.5 A	Steering column control module. Instrument cluster.
35	5 A	Rear heated seats.
36	7.5 A	Manual shift. Select shift switch.

Fuses

Item	Rating	Protected Component
37	5 A	Head up display.
38	7.5 A	Telematics control unit.
39	—	Not used.
40	10 A	Left-hand door switch. Telescopic exterior mirror switch.
41	10 A	Adjustable pedals.
42	5 A	Central security module.
43	5 A	Headlamps. Ignition switch.
44	30 A	Driver door module.
45	7.5 A	Wireless accessory charger module. Driver front seat module.
46	20 A	Radio.
47	—	Not used.
48	—	Not used.
49	7.5 A	SYNC display screen.
50	5 A	Auxiliary smart data link connector.
51	—	Not used.

Fuses

IDENTIFYING FUSE TYPES

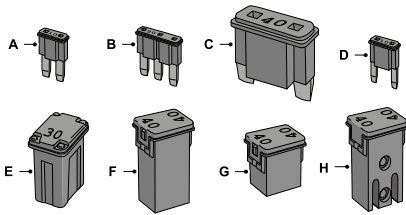

- A Micro 2.
- B Micro 3.
- C Maxi.
- D Mini.
- E M Case.
- F J Case.
- G J Case Low Profile.
- H Slotted M Case.

FUSES – TROUBLESHOOTING

FUSES – FREQUENTLY ASKED QUESTIONS

When do I need to check a fuse?

- If electrical components in the vehicle are not working.

When do I need to replace a fuse?

- If a fuse has blown.

How do I identify a blown fuse?

- You can identify a blown fuse by a broken wire within the fuse.

Maintenance

MAINTENANCE PRECAUTIONS

Service your vehicle regularly to help maintain its roadworthiness and resale value. There is a large network of authorized dealers that are there to help you with their professional servicing expertise. We believe that their specially trained technicians are best qualified to service your vehicle properly and expertly. They are supported by a wide range of highly specialized tools developed specifically for servicing your vehicle.

If your vehicle requires professional service, an authorized dealer can provide the necessary parts and service. Check your warranty information to find out which parts and services are covered.

Use only recommended fuels, lubricants, fluids and service parts conforming to specifications.

- Do not work on a hot engine.
- Make sure that nothing gets caught in moving parts.
- Do not work on a vehicle with the engine running in an enclosed space, unless you are sure you have enough ventilation.
- Keep all open flames and other burning material, such as cigarettes, away from the battery and all fuel related parts.
- Set the parking brake, shift the transmission to park (P) and block the wheels.

OPENING AND CLOSING THE HOOD

1. Inside the vehicle, pull the hood release handle located under the left-hand side of the instrument panel.

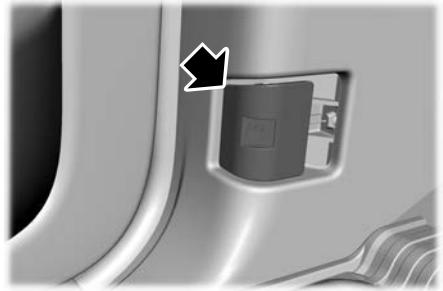

2. Go to the front of your vehicle and locate the secondary release lever under the front of the hood near the center of your vehicle.

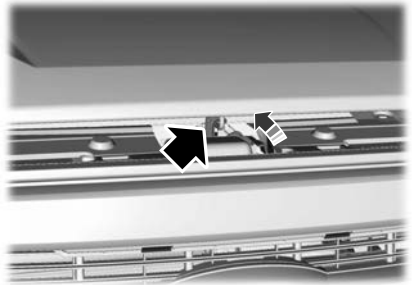

3. Raise the hood until the lift cylinders hold it open.
4. To close, lower the hood and make sure that it is properly closed and fully latched.

Warning Lamps and Indicators

Hood Ajar



It illuminates when the ignition is on and the hood is not completely closed.

Maintenance

UNDER HOOD OVERVIEW - 6.7L DIESEL

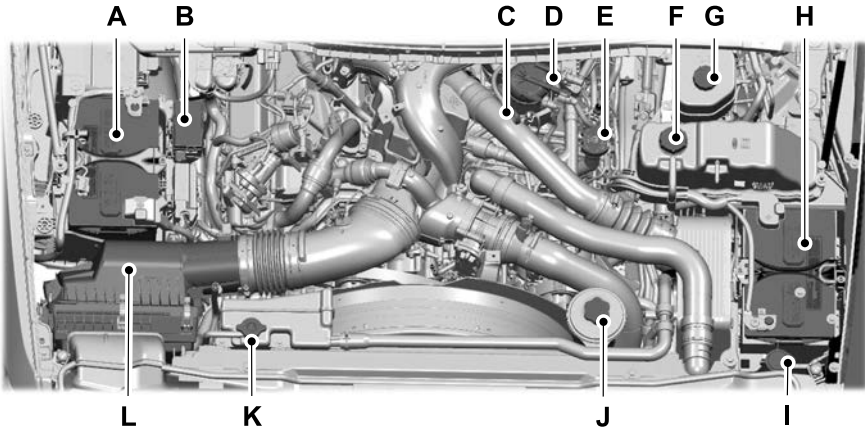

- A Battery. See **Changing the 12V Battery** (page 471).
- B Under hood fuse box. See **Accessing the Under Hood Fuse Box** (page 434).
- C Engine oil dipstick. See **Engine Oil Dipstick Overview** (page 449).
- D Secondary fuel filter. See **Changing the Fuel Filter** (page 467).
- E Engine oil filler cap. See **Checking the Engine Oil Level** (page 449).
- F Engine cooling system coolant reservoir - primary high-temperature cooling system. See **Checking the Coolant Level** (page 462).
- G Brake fluid reservoir. See **Checking the Brake Fluid** (page 251).
- H Battery. See **Changing the 12V Battery** (page 471).
- I Windshield washer fluid reservoir. See **Adding Washer Fluid** (page 107).
- J Power steering fluid reservoir. See **Checking the Hydraulic Power Steering Fluid** (page 278).
- K Secondary cooling system coolant reservoir. See **Checking the Coolant Level** (page 462).
- L Air filter assembly. See **Changing the Engine Air Filter** (page 457).

Maintenance

UNDER HOOD OVERVIEW - 6.8L, GASOLINE

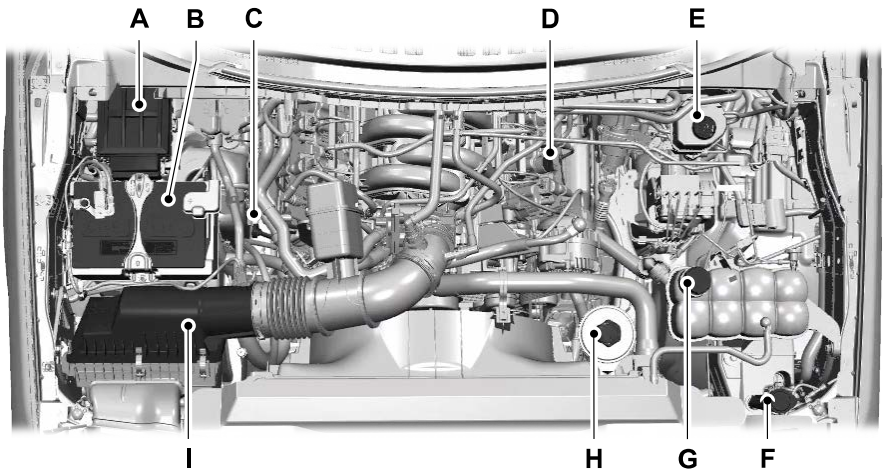

- A Engine compartment fuse box. See **Locating the Under Hood Fuse Box** (page 434).
- B Battery. See **Changing the 12V Battery** (page 471).
- C Engine oil dipstick. See **Engine Oil Dipstick Overview** (page 449).
- D Engine oil filler cap. See **Checking the Engine Oil Level** (page 449).
- E Brake fluid reservoir. See **Checking the Brake Fluid** (page 251).
- F Windshield washer fluid reservoir. See **Adding Washer Fluid** (page 107).
- G Engine coolant reservoir. See **Checking the Coolant Level** (page 462).
- H Power steering fluid reservoir. See **Checking the Hydraulic Power Steering Fluid** (page 278).
- I Air cleaner assembly. See **Changing the Engine Air Filter** (page 457).

Maintenance

UNDER HOOD OVERVIEW - 7.3L, GASOLINE

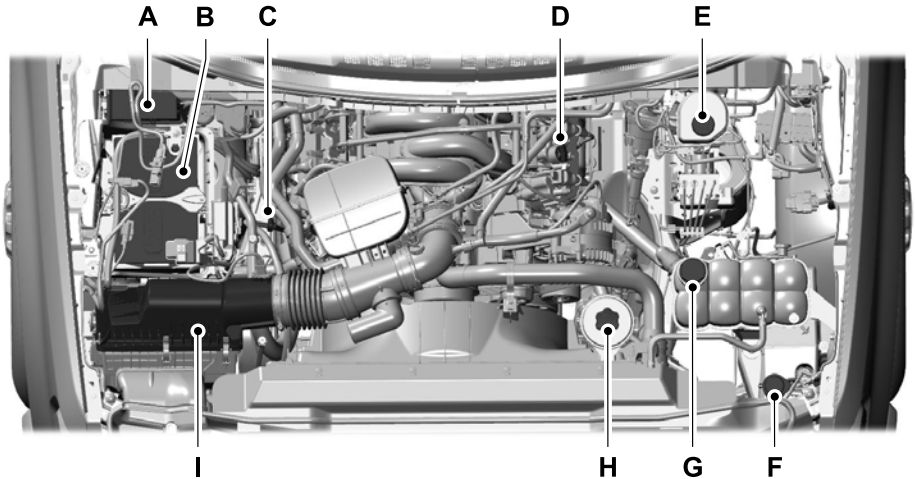

- A Under hood fuse box. See **Accessing the Under Hood Fuse Box** (page 434).
- B Battery. See **Changing the 12V Battery** (page 471).
- C Engine oil dipstick. See **Engine Oil Dipstick Overview** (page 449).
- D Engine oil filler cap. See **Adding Engine Oil** (page 450).
- E Brake fluid reservoir. See **Checking the Brake Fluid** (page 251).
- F Windshield washer fluid reservoir. See **Adding Washer Fluid** (page 107).
- G Engine coolant reservoir. See **Checking the Coolant Level** (page 462).
- H Power steering fluid reservoir. See **Checking the Hydraulic Power Steering Fluid** (page 278).
- I Air cleaner assembly. See **Changing the Engine Air Filter** (page 457).

Maintenance

ENGINE OIL

ENGINE OIL DIPSTICK OVERVIEW - DIESEL

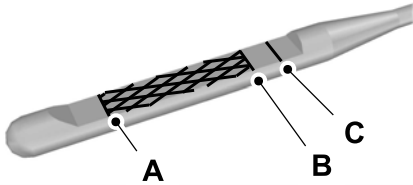

- A Minimum.
- B Nominal.
- C Maximum.

ENGINE OIL DIPSTICK OVERVIEW - GASOLINE

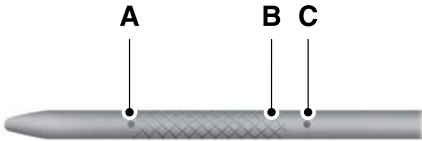

- A Minimum.
- B Nominal.
- C Maximum.

CHECKING THE ENGINE OIL LEVEL

1. Make sure that your vehicle is on level ground.
2. Check the oil level before starting the engine, or switch the engine off after warm up and wait 15 minutes for the oil to drain into the oil pan.

Note: *Checking the oil level too soon could result in an inaccurate reading.*

3. Remove the dipstick and wipe it with a clean, lint-free cloth.
4. Reinstall the dipstick and make sure it is fully seated.
5. Remove the dipstick again to check the oil level.

Note: *Read both sides of the dipstick and use the lowest oil level as the correct reading.*

Note: *If the oil level is between the maximum and minimum marks, the oil level is acceptable. Do not add oil.*

6. If the oil level is at the minimum mark, immediately add oil.
7. Reinstall the dipstick. Make sure it is fully seated.

Note: *The oil consumption of new engines reaches its normal level after approximately 5,000 km (3,000 mi).*

Note: *Increases in oil level can occur from frequent short trips that do not allow the engine to get to operating temperature, as well as frequent idling or low speed driving for long periods of time.*

Note: *If oil levels are continuously noted above the maximum mark, have your vehicle checked as soon as possible.*

Maintenance

ADDING ENGINE OIL



WARNING: Do not remove the filler cap when the engine is running.



WARNING: Do not add engine oil when the engine is hot. Failure to follow this instruction could result in personal injury.

Do not use supplemental engine oil additives because they are unnecessary and could lead to engine damage that the vehicle warranty may not cover.

1. Clean the area surrounding the engine oil filler cap before you remove it.
2. Remove the engine oil filler cap.
3. Add engine oil that meets our specifications. See **Engine Oil** (page 450).
4. Reinstall the engine oil filler cap. Turn it clockwise until you feel a strong resistance.

Note: *Do not add oil further than the maximum mark. Oil levels above the maximum mark may cause engine damage.*

Note: *Immediately soak up any oil spillage with an absorbent cloth.*

INTELLIGENT OIL LIFE MONITOR

Under certain conditions the vehicle's intelligent oil life monitor may determine your oil requires replacement prior to your general service. Should this occur it is recommended you replace your oil within two weeks or 800 km (500 mi) of being alerted.

Your authorized dealer will be able to advise you whether only an engine oil and filter change is recommended or whether you should complete your general service inclusive of oil and oil Filter.

RESETTING THE INTELLIGENT OIL LIFE MONITOR

1. Press the Menu button on the steering wheel to enter the instrument cluster display main menu.
2. Select **Vehicle Maintenance**.
3. Select **Oil Life**.
4. Press and hold the **OK** button until the system reset confirmation appears.

ENGINE OIL CAPACITY AND SPECIFICATION - 6.7L DIESEL

Use oil that meets the defined specification and viscosity grade.

If you do not use oil that meets the defined specification and viscosity grade, it could result in:

- Component damage that your vehicle warranty does not cover.
- Longer engine cranking periods.
- Increased emission levels.
- Reduced vehicle performance.
- Reduced fuel economy.

Engine Oil

We recommend Motorcraft motor oil for your vehicle. If Motorcraft motor oil is not available, use motor oil of the recommended viscosity grade that meets our specification WSS-M2C171-F1. You can find the list of approved motor oils at www.motorcraft.com.

Do not use supplemental engine oil additives because they are unnecessary and could lead to engine damage that your vehicle warranty does not cover.

Maintenance

The use of correct oil viscosities for diesel engines is important for satisfactory operation. Determine which oil viscosity best suits the temperature range you expect to encounter for the next service interval from the SAE Viscosity Grades chart.

Note: An engine block heater is recommended at temperatures below -23°C (-9°F).

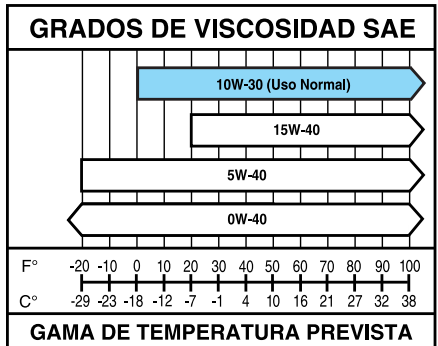
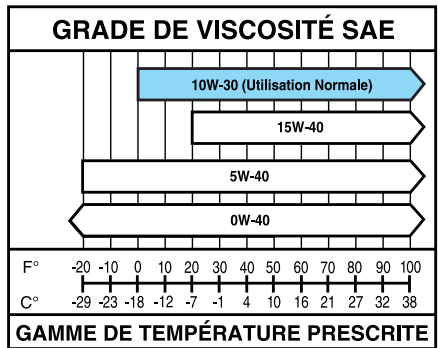
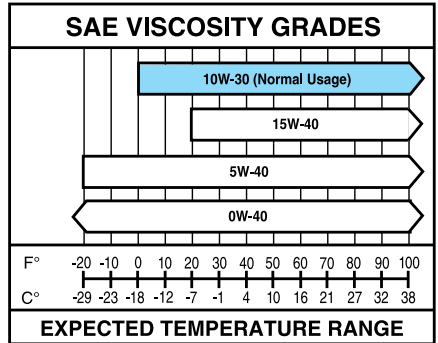

Maintenance

Capacities

Variant	Including the Oil Filter
All.	14.2 L (15.0 qt)

Materials

Name	Specification
Motorcraft® SAE 10W-30 Super Duty Diesel Motor Oil(U.S.) Motorcraft® Super Duty Motor Oil SAE 10W-30 / Huile moteur Super Duty SAE 10W-30 Motor- craft®(Canada) XO-10W30-QSDF(U.S.) CXO-10W30-LSD12(Canada)	WSS-M2C171-F1

Alternative Engine Oil for Extremely Cold Climates

To improve engine cold start performance, we recommend that you use the following alternative engine oil in extremely cold climates, where the ambient temperature reaches -30°C (-22.0°F) or below.

Materials

Name	Specification
Engine Oil - SAE 0W-40	WSS-M2C171-F1

Alternative Engine Oil for Biodiesel Fuel Blends (B20 Max)

Maintenance

Materials

Name	Specification
Motorcraft® SAE 5W-40 Full Synthetic Diesel Motor Oil (U.S.) (Canada) XO-5W40-5Q3SD (U.S.)	WSS-M2C171-F1
Motorcraft® SAE 15W-40 Super Duty Diesel Motor Oil (U.S.) Motorcraft® Super Duty Motor Oil SAE 15W-40 / Huile moteur Super Duty SAE 15W-40 Motor- craft® (Canada) XO-15W40-QSDF (U.S.) CXO-15W40-LSD12 (Canada)	WSS-M2C171-F1

Alternative Engine Oil for Severe Duty Service

Materials

Name	Specification
Motorcraft® SAE 5W-40 Full Synthetic Diesel Motor Oil (U.S.) (Canada) XO-5W40-5Q3SD (U.S.)	WSS-M2C171-F1

ENGINE OIL CAPACITY AND SPECIFICATION - 6.8L, GASOLINE

Use oil that meets the defined specification and viscosity grade.

If you do not use oil that meets the defined specification and viscosity grade, it could result in:

- Component damage that your vehicle warranty does not cover.
- Longer engine cranking periods.
- Increased emission levels.
- Reduced vehicle performance.
- Reduced fuel economy.



An oil that displays this symbol conforms to current engine, emission system and fuel economy performance standards of ILSAC.

Maintenance

We recommend Motorcraft motor oil for your vehicle. If Motorcraft oil is not available, use motor oils of the recommended viscosity grade that display the API Certification Mark for gasoline

engines.

Do not use supplemental engine oil additives because they are unnecessary and could lead to engine damage that your vehicle warranty does not cover.

Capacities

Variant	Including the Oil Filter
All.	7.57 L (8.0 qt)

Materials

Name	Specification
Motorcraft® SAE 5W-30 Motor Oil (U.S.) Motorcraft® SAE 5W-30 Motor Oil / Huile moteur SAE 5W-30 Motorcraft® (Canada) XO-5W30-Q1SP, XO-5W30-Q1FS (U.S.) CXO-5W30-LSP6, CXO-5W30-LFS6 (Canada)	WSS-M2C961-A1

Alternative Engine Oil for Extremely Cold Climates

To improve engine cold start performance, we recommend that you use the following alternative engine oil in extremely cold climates, where the ambient temperature reaches -30°C (-22°F) or below.

Materials

Name	Specification
Engine Oil - SAE 0W-30	WSS-M2C963-A1

Maintenance

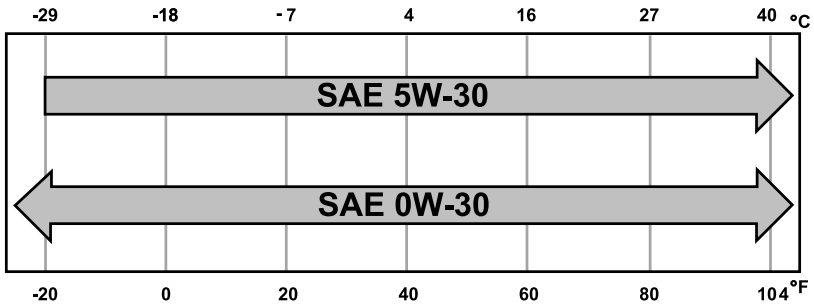

Note: If you use your vehicle regularly above the altitude of 1,524 m (5,000 ft) and under the temperature of -20°C (-4.0°F), it is recommended to use the alternative engine oil.

ENGINE OIL CAPACITY AND SPECIFICATION - 7.3L, GASOLINE

Use oil that meets the defined specification and viscosity grade.

If you do not use oil that meets the defined specification and viscosity grade, it could result in:

- Component damage that your vehicle warranty does not cover.
- Longer engine cranking periods.
- Increased emission levels.
- Reduced vehicle performance.
- Reduced fuel economy.



An oil that displays this symbol conforms to current engine, emission system and fuel economy performance standards of ILSAC.

We recommend Motorcraft motor oil for your vehicle. If Motorcraft oil is not available, use motor oils of the recommended viscosity grade that display the API Certification Mark for gasoline engines.

Do not use supplemental engine oil additives because they are unnecessary and could lead to engine damage that your vehicle warranty does not cover.

Maintenance

Capacities

Variant	Including the Oil Filter
All.	7.57 L (8.0 qt)

Materials

Name	Specification
Motorcraft® SAE 5W-30 Motor Oil (U.S.) Motorcraft® SAE 5W-30 Motor Oil / Huile moteur SAE 5W-30 Motorcraft® (Canada) XO-5W30-Q1SP, XO-5W30-Q1FS (U.S.) CXO-5W30-LSP6, CXO-5W30-LFS6 (Canada)	WSS-M2C961-A1

Alternative Engine Oil for Extremely Cold Climates

To improve engine cold start performance, we recommend that you use the following alternative engine oil in extremely cold climates, where the ambient temperature reaches -30°C (-22°F) or below.

Materials

Name	Specification
Engine Oil - SAE 0W-30	WSS-M2C963-A1

Maintenance

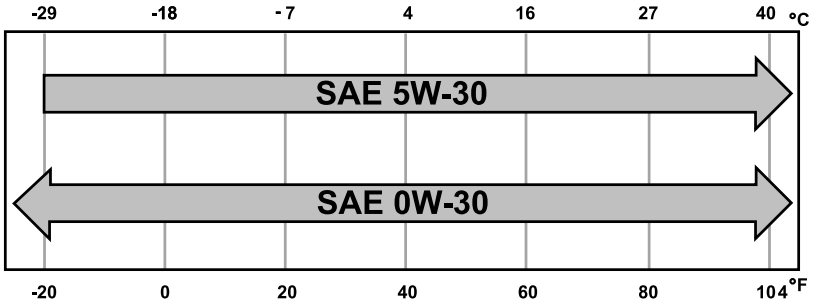

Note: If you use your vehicle regularly above the altitude of 1,524 m (5,000 ft) and under the temperature of -20°C (-4.0°F), it is recommended to use the alternative engine oil.

Your vehicle may be equipped with an electronic engine air filter maintenance minder. The air filter minder provides optimized service intervals and reminders based on driving habits and environmental conditions.

ENGINE AIR FILTER

CHANGING THE ENGINE AIR FILTER



WARNING: To reduce the risk of vehicle damage and personal burn injuries, do not start your engine with the air cleaner removed and do not remove it while the engine is running.

Use the correct specification air filter element. See **Engine Air Filter** (page 457).

Note: Failure to use the correct air filter element may result in severe engine damage not covered by the vehicle warranty.

Change the air filter element at the correct service interval. See **Scheduled Maintenance** (page 586).

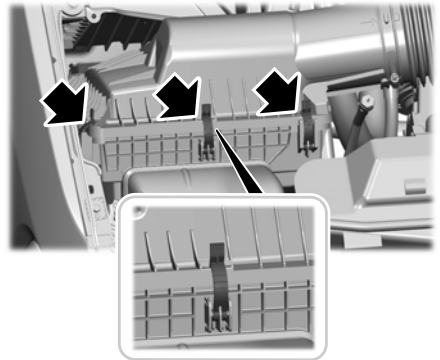

1. Clean any loose dirt or debris around the air filter housing.
2. Disconnect the mass air flow sensor electrical connector, if required.

Maintenance

3. Remove the three clips that secure the air filter housing cover. Remove the air filter housing cover. Disconnect and pull the air intake tube away, as needed.

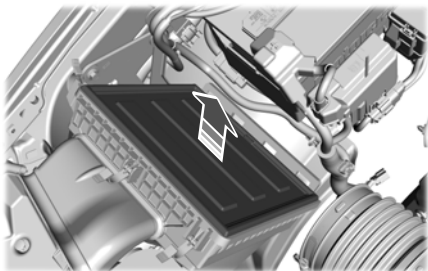

4. Remove the air filter element from the air filter housing.
5. Inspect the air filter element for any damage. Replace the air filter element if the seal, paper, foam or steel mesh has any holes, cuts or gouges.
6. Inspect the air filter housing for dirt, dust, snow, ice or debris in the air cleaner tray.
7. Reverse the removal procedure to install. You can oscillate the housing cover slightly left to right as needed until you are able to engage all three clips.

Note: For diesel applications, make sure the arrow on the new air filter element points toward the front of the vehicle.

After operating your vehicle during heavy snowfall or extreme rain, do the following:

- Snow: At the earliest opportunity, open the hood, clear any snow and ice from the air filter housing inlet.
- Extreme rain: Allow the air filter element to dry out for approximately 15–30 minutes of driving at highway speeds.

Note: Do not remove the foam block from the air cleaner tray.

RESETTING THE AIR FILTER REMINDER

1. Press the menu button on the steering wheel to enter the instrument cluster display main menu.
2. Select **Vehicle Maintenance**.
3. Select **Engine Air Filter**.
4. Press and hold the **OK** button until the system reset confirmation appears.

Note: The system displays 100% after being successfully reset.

Maintenance

ENGINE AIR FILTER – INFORMATION MESSAGES

Message	Details
Replace Engine Air Filter Soon	Replace the engine air filter at the earliest opportunity.
Replace Engine Air Filter Now	Indicates an air filter at the end of useful life. After engine air filter replacement, you must reset the system in order to change the status. See Resetting the Air Filter Reminder (page 458).
Check Engine Air Filter See Manual	Indicates that there is a higher-than-expected restriction across the engine air filter, which could represent an air filter at the end of useful life or a filter with an obstruction. When this displays, inspect the engine air filter and replace if necessary. If you do not replace the air filter, there is no need for you to reset the air filter minder. The system resets the minder after you clear the obstruction and drive your vehicle for about an hour. If you replace the air filter, you need to reset the minder to change the status. See Resetting the Air Filter Reminder (page 458).
Engine Air Filter Fault See Manual	Indicates that there is an error within the electronic air filter maintenance minder system requiring service.
Engine Power Reduced Inspect Air Filter	When this displays, inspect the engine air filter and replace if necessary. If you do not replace the air filter, there is no need for you to reset the air filter minder. The system resets the minder after you clear the obstruction and drive your vehicle for about an hour. If you replace the air filter, you need to reset the minder to change the status. See Resetting the Air Filter Reminder (page 458).

DRAINING THE FUEL FILTER WATER TRAP - DIESEL



WARNING: Do not drain the water-in-fuel separator while the engine is running. Failure to follow this warning may result in fire, serious injury, death or property damage.



WARNING: Do not dispose of fuel in the household refuse or the public sewage system. Use an authorized waste disposal facility.

Your vehicle has a diesel fuel conditioner module. The module is mounted between the outboard side of the fuel tank and the frame rail.

Note: *The module is at the front of the fuel tank or at the front of the aft-axle fuel tank on some models.*

Maintenance



You should drain water from the module assembly whenever the warning light illuminates or a message appears in the information display advising you to drain the water separator. This occurs when approximately 200 ml (6.76 fl oz) of water accumulates in the module. If you allow the water level

to exceed this level, the water may pass through to the engine and may cause fuel injection equipment damage.

Filter Location

Use the tables below to find the location of your filter.

Pick-up Truck

Cab Type	Box Length	Filter Location
Regular.	2.4 m (8 ft)	Left side of fuel tank.
SuperCab.	2.057 m (6.75 ft)	
	2.4 m (8 ft)	In front of fuel tank.
Super Crew Cab.	2.057 m (6.75 ft)	Left side of fuel tank.
	2.4 m (8 ft)	

Chassis Cab

Cab Type	Fuel Tank Type	Filter Location
Chassis Cab.	Single midship fuel tank	Right side of fuel tank.
Chassis Cab.	Aft axle/midship fuel tanks	Right side of midship fuel tank.
Chassis Cab.	Single aft axle fuel tank	Front of fuel tank.

Draining the Diesel Fuel Conditioner Module

1. Switch the engine off.
2. Access the underside of your vehicle.

Maintenance

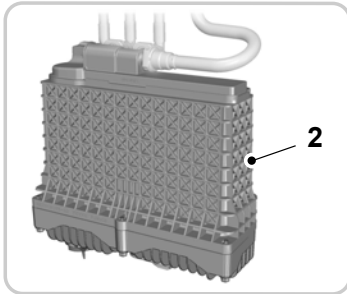
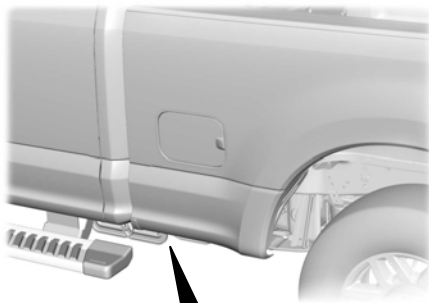

3. Use the table to find the location of your fuel filter.

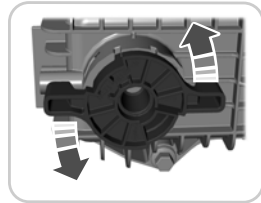
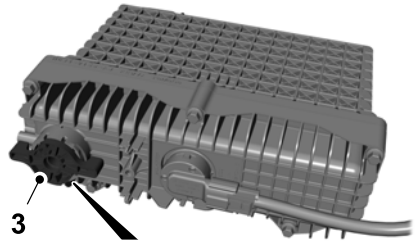



4. Drain the diesel fuel conditioner module. Turn the drain plug counterclockwise until it stops. Do not use any tools to loosen the drain plug. Drain the filter, approximately 2 L (0.5 gal), into an appropriate container. Do not re-use the fuel drained from the module.
5. Tighten the drain plug, turn it clockwise until it stops and you feel a strong resistance. Do not use any tools to tighten the drain plug.
6. Prime the system by turning the key to the on position for 30 seconds. Turn the key to the off position, then the on position again for another 30 seconds. Repeat this twice.

Maintenance

COOLANT

CHECKING THE COOLANT LEVEL

 **WARNING:** Do not remove the coolant reservoir cap when the engine is on or the cooling system is hot. Wait 10 minutes for the cooling system to cool down. Cover the coolant reservoir cap with a thick cloth to prevent the possibility of scalding and slowly remove the cap. Failure to follow this instruction could result in personal injury.

 **WARNING:** To reduce the risk of personal injury, make sure the engine is cool before unscrewing the coolant pressure relief cap. The cooling system is under pressure. Steam and hot liquid can come out forcefully when you loosen the cap slightly.

When the engine is cold, check the concentration and level of the coolant at the intervals listed in the scheduled maintenance information. See **Scheduled Maintenance** (page 586).

Note: Make sure that the coolant level is between the **MIN** and the **MAX** marks on the coolant reservoir.

Note: Coolant expands when it is hot. The level may extend beyond the **MAX** mark. This is normal.

Maintain coolant concentration within 48% to 50%, which equates to a freeze point between -34°C (-29°F) and -37°C (-35°F). Coolant concentration should be checked using a refractometer. We do not recommend the use of hydrometers or coolant test strips for measuring coolant concentration.

ADDING COOLANT

 **WARNING:** Do not add coolant when the vehicle is on or the cooling system is hot. Failure to follow this instruction could result in personal injury.

 **WARNING:** Do not remove the coolant reservoir cap when the engine is on or the cooling system is hot. Wait 10 minutes for the cooling system to cool down. Cover the coolant reservoir cap with a thick cloth to prevent the possibility of scalding and slowly remove the cap. Failure to follow this instruction could result in personal injury.

 **WARNING:** Do not allow the fluid to touch your skin or eyes. If this happens, rinse the affected areas immediately with plenty of water and contact your physician.

 **WARNING:** Do not put coolant in the windshield washer reservoir. If sprayed on the windshield, coolant could make it difficult to see through the windshield.

 **WARNING:** Do not add coolant further than the **MAX** mark.

Note: Do not use stop leak pellets, cooling system sealants, or non-specified additives as they can cause damage to the engine cooling or heating systems. Resulting component damage may not be covered by the vehicle Warranty.

Note: Automotive fluids are not interchangeable.

Maintenance

It is very important to use prediluted coolant approved to the correct specification in order to avoid plugging the small passageways in the engine cooling system. See **Coolant** (page 464). Do not mix different colors or types of coolant in your vehicle. Mixing of engine coolants or using an incorrect coolant may harm the engine or cooling system components and may not be covered by the vehicle Warranty.

Note: *If prediluted coolant is not available, use the approved concentrated coolant diluting it to 50/50 with deionised or distilled water. See **Coolant** (page 464). Using water that has not been deionised may contribute to deposit formation, corrosion and plugging of the small cooling system passageways.*

Note: *Coolants marketed for all makes and models may not be approved to our specifications and may cause damage to the cooling system. Resulting component damage may not be covered by the vehicle Warranty.*

If the coolant level is at or below the minimum mark, add prediluted coolant immediately.

To top up the coolant level do the following:

1. Unscrew the cap slowly. Any pressure escapes as you unscrew the cap.
2. Add prediluted coolant approved to the correct specification. See **Coolant** (page 464).
3. Add enough prediluted coolant to reach the correct level.
4. Replace the coolant reservoir cap. Turn the cap clockwise until it contacts the hard stop.

5. Check the coolant level in the coolant reservoir the next few times you drive your vehicle. If necessary, add enough prediluted engine coolant to bring the coolant level to the correct level.

If you have to add more than 1 L (1.1 qt) of engine coolant per month, have your vehicle checked as soon as possible. Operating an engine with a low level of coolant can result in engine overheating and possible engine damage.

In case of emergency, you can add a large amount of water without engine coolant in order to reach a vehicle service location.

Water alone, without engine coolant, can cause engine damage from corrosion, overheating or freezing.

Do not use the following as a coolant substitute:

- Alcohol.
- Methanol.
- Brine.
- Any coolant mixed with alcohol or methanol antifreeze.

Alcohol and other liquids can cause engine damage from overheating or freezing.

Do not add extra inhibitors or additives to the coolant. These can be harmful and compromise the corrosion protection of the coolant.

CHANGING THE COOLANT

For coolant change, see your authorized dealer.

Changing the coolant is necessary at specific mileage intervals listed in the scheduled maintenance information. See **Scheduled Maintenance** (page 586).

Maintenance

MANAGING THE COOLANT TEMPERATURE

If you tow a trailer with your vehicle, the engine may temporarily reach a higher temperature during severe operating conditions, for example ascending a long or steep grade in high ambient temperatures.

At this time, you may notice the coolant temperature gauge moves toward the red zone and a message may appear in the information display.



WARNING: To reduce the risk of crash and injury, be prepared that the vehicle speed may reduce and the vehicle may not be able to accelerate with full power until the coolant temperature reduces.



WARNING: If you continue to drive your vehicle when the engine is overheating, the engine could stop without warning. Failure to follow this instruction could result in the loss of control of your vehicle.

You may notice a reduction in vehicle speed caused by reduced engine power in order to manage the engine coolant temperature. Your vehicle may enter this mode if certain high-temperature and high-load conditions take place. The amount of speed reduction depends on vehicle loading, grade and outside temperature. If this occurs, there is no need to stop your vehicle. You can continue to drive. See **Fail-Safe Cooling** (page 429).

The air conditioning may automatically turn on and off during severe operating conditions to protect the engine from overheating. When the coolant temperature decreases to the normal operating temperature, the air conditioning turns on.

If the coolant temperature gauge moves fully into the red zone, or if the coolant temperature warning or service engine soon messages appear in your information display, do the following:

1. Stop your vehicle as soon as it is safe to do so. Fully apply the parking brake, shift into park (P) or neutral (N).
2. Leave the engine running until the coolant temperature gauge needle returns to the normal position. If the temperature does not drop after several minutes, follow the remaining steps.
3. Switch the engine off and wait for it to cool. Check the coolant level.
4. If the coolant level is at or below the minimum mark, add prediluted coolant immediately.
5. If the coolant level is normal, restart the engine and continue.

COOLING SYSTEM CAPACITY AND SPECIFICATION - 6.7L DIESEL

Use coolant that meets the defined specification.

If you do not use coolant that meets the defined specification, it could result in:

- Component damage that your vehicle warranty does not cover.
- Reduced vehicle performance.

Note: An engine block heater is recommended at temperatures below -23°C (-9°F).

Maintenance

Capacities

Variant	Quantity
Primary cooling system.	30 L (31.7 qt)
Primary cooling system with auxiliary radiator.	31.5 L (33.3 qt)
Secondary cooling system with urea injector cooling.	7.8 L (8.2 qt)
Secondary cooling system with urea injector cooling and cooled compressor.	9.5 L (10.0 qt)

Materials

Name	Specification
Motorcraft® Yellow Prediluted Antifreeze/Coolant (U.S.) Motorcraft® Yellow Prediluted Antifreeze/Coolant / Antigel/liquide de refroidissement prédilué jaune Motorcraft® (Canada) VC-13DL-G (U.S.) CVC-13DL-G (Canada)	WSS-M97B57-A2

COOLING SYSTEM CAPACITY AND SPECIFICATION - 6.8L, GASOLINE

Use coolant that meets the defined specification.

If you do not use coolant that meets the defined specification, it could result in:

- Component damage that your vehicle warranty does not cover.
- Reduced vehicle performance.

Capacities

Variant	Quantity
All.	21.3 L (22.5 qt)

Maintenance

Materials

Name	Specification
Motorcraft® Yellow Prediluted Antifreeze/ Coolant(U.S.) Motorcraft® Yellow Prediluted Antifreeze/Coolant / Antigel/liquide de refroidissement prédilué jaune Motorcraft®(Canada) VC-13DL-G(U.S.) CVC-13DL-G(Canada)	WSS-M97B57-A2

COOLING SYSTEM CAPACITY AND SPECIFICATION - 7.3L, GASOLINE

Use coolant that meets the defined specification.

If you do not use coolant that meets the defined specification, it could result in:

- Component damage that your vehicle warranty does not cover.
- Reduced vehicle performance.

Capacities

Variant	Quantity
All.	21.3 L (22.5 qt)

Materials

Name	Specification
Motorcraft® Yellow Prediluted Antifreeze/ Coolant(U.S.) Motorcraft® Yellow Prediluted Antifreeze/Coolant / Antigel/liquide de refroidissement prédilué jaune Motorcraft®(Canada) VC-13DL-G(U.S.) CVC-13DL-G(Canada)	WSS-M97B57-A2

COOLANT – WARNING LAMPS



If the engine begins to overheat, the coolant temperature gauge moves toward the red zone.



A warning lamp illuminates and a message may appear in the information display.

Maintenance

COOLANT – INFORMATION MESSAGES

Message	Description and Action
High engine temperature Stop safely	Displays when the engine temperature is too high. Stop your vehicle as soon as it is safe to do so, switch the engine off and allow it to cool. If the problem persists, have your vehicle checked as soon as possible. See Checking the Coolant Level (page 462).

CHANGING THE FUEL FILTER - DIESEL

Your fuel filters must be changed at the correct service interval or when you see the low fuel pressure message appear. Refer to scheduled maintenance for the correct service interval.

CHANGING THE FUEL FILTER - GASOLINE

Your vehicle has a lifetime fuel filter that integrates with the fuel tank. It does not need regular maintenance or replacement.

DRIVE BELT ROUTING OVERVIEW - 6.7L DIESEL, VEHICLES WITH:110-120V 2KW PICKUP BED POWER OUTLET/ DUAL GENERATORS

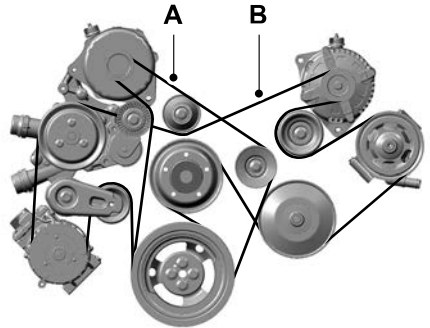

A.	Drivebelt furthest from the engine.
B.	Drivebelt closest to the engine.

Maintenance

DRIVE BELT ROUTING OVERVIEW - 6.7L DIESEL, VEHICLES WITH: DUAL GENERATORS

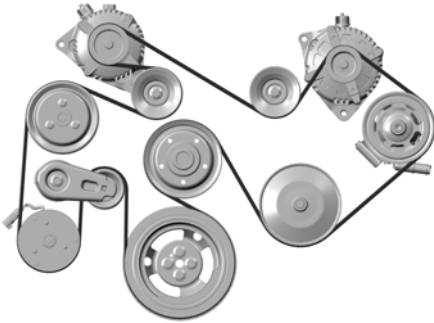

DRIVE BELT ROUTING OVERVIEW - 6.8L, GASOLINE, VEHICLES WITH: DUAL GENERATORS

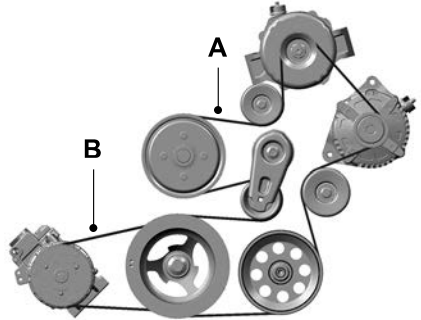

DRIVE BELT ROUTING OVERVIEW - 6.7L DIESEL, VEHICLES WITH: SINGLE GENERATOR

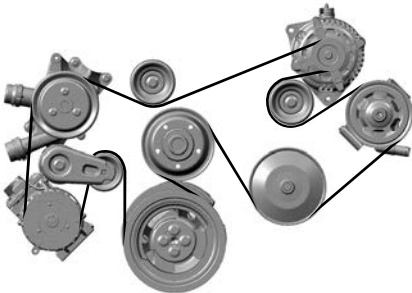

A.	Drivebelt furthest from the engine.
B.	Drivebelt closest to the engine.

Maintenance

DRIVE BELT ROUTING OVERVIEW - 6.8L, GASOLINE, VEHICLES WITH: SINGLE GENERATOR

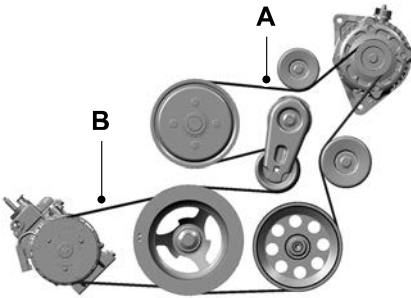

A.	Drivebelt furthest from the engine.
B.	Drivebelt closest to the engine.

DRIVE BELT ROUTING OVERVIEW - 7.3L, GASOLINE, VEHICLES WITH: DUAL GENERATORS

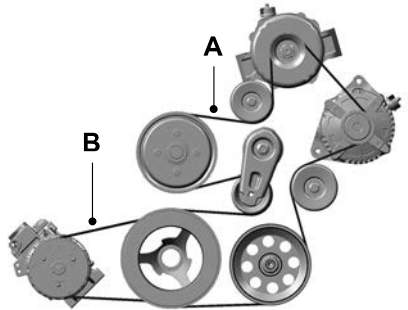

A.	Drivebelt furthest from the engine.
B.	Drivebelt closest to the engine.

Maintenance

DRIVE BELT ROUTING OVERVIEW - 7.3L, GASOLINE, VEHICLES WITH: SINGLE GENERATOR

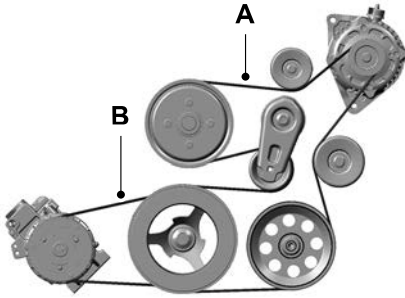

A.	Drivebelt furthest from the engine.
B.	Drivebelt closest to the engine.

12V BATTERY

12V BATTERY PRECAUTIONS

WARNING: Batteries normally produce explosive gases which can cause personal injury. Therefore, do not allow flames, sparks or lighted substances to come near the battery. When working near the battery, always shield your face and protect your eyes. Always provide correct ventilation.

WARNING: When lifting a plastic-cased battery, excessive pressure on the end walls could cause acid to flow through the vent caps, resulting in personal injury and damage to the vehicle or battery. Lift the battery with a battery carrier or with your hands on opposite corners.

WARNING: Keep batteries out of reach of children. Batteries contain sulfuric acid. Avoid contact with skin, eyes or clothing. Shield your eyes when working near the battery to protect against possible splashing of acid solution. In case of acid contact with skin or eyes, flush immediately with water for a minimum of 15 minutes and get prompt medical attention. If acid is swallowed, call a physician immediately.

WARNING: Battery posts, terminals and related accessories contain lead and lead compounds, chemicals known to the State of California to cause cancer and reproductive harm. **Wash your hands after handling.**

WARNING: This vehicle may have more than one battery. Removing the battery cables from only one battery does not disconnect your vehicle electrical system. Make sure you disconnect the battery cables from all batteries when disconnecting power. Failure to do so may cause serious personal injury or property damage.

WARNING: For vehicles with Auto-Start-Stop the battery requirement is different. You must replace the battery with one of exactly the same specification.

Maintenance

WHAT IS THE BATTERY MANAGEMENT SYSTEM

The battery management system monitors battery conditions and takes actions to extend battery life.

HOW DOES THE BATTERY MANAGEMENT SYSTEM WORK

If excessive battery drain is detected, the system temporarily disables some electrical systems to protect the battery.

Systems included are:

- Heated rear window.
- Heated seats.
- Climate control.
- Heated steering wheel.
- Audio unit.
- Navigation system.

A message could appear in the information display to alert you that battery protection actions are active. This message is only for notification that an action is taking place, and not intended to indicate an electrical problem or that the battery requires replacement.

BATTERY MANAGEMENT SYSTEM LIMITATIONS

After battery replacement, or in some cases after charging the battery with an external charger, the battery management system requires eight hours of vehicle sleep time to relearn the battery state of charge. During this time, your vehicle must remain fully locked with the ignition switched off.

Note: *Prior to relearning the battery state of charge, the battery management system could temporarily disable some electrical systems.*

Electrical Accessory Installation

To make sure the battery management system works correctly, do not connect an electrical device ground connection directly to the battery negative post. This can cause inaccurate measurements of the battery condition and potential incorrect system operation.

Note: *If you add electrical accessories or components to the vehicle, it could adversely affect battery performance and durability. This could also affect the performance of other electrical systems in the vehicle.*

CHANGING THE 12V BATTERY

The battery is in the engine compartment. See **Maintenance** (page 445).

Your vehicle has a maintenance-free battery. It does not require additional water during service.

If the vehicle battery has a cover, make sure you correctly install it after cleaning or replacing the battery.

For longer, trouble-free operation, keep the top of the battery clean and dry and the battery cables tightly fastened to the battery terminals. If any corrosion is present on the battery or terminals, remove the cables from the terminals and clean with a wire brush. You can neutralize the acid with a solution of baking soda and water.

We recommend that you disconnect the negative battery cable terminal from the battery if you plan to store your vehicle for an extended period.

Note: *If you only disconnect the negative battery cable terminal, make sure it is isolated or placed away from the battery terminal to avoid unintended connection or arcing.*

Maintenance

If you disconnect or replace the battery and your vehicle has an automatic transmission, it must relearn its adaptive strategy. Because of this, the transmission may shift firmly when first driven. This is normal operation while the transmission fully updates its operation to optimum shift feel.

Removing the Battery

1. Apply the parking brake and switch the ignition off.
2. Switch all electrical equipment off, for example lights and radio.
3. Wait a minimum of two minutes before disconnecting the battery.

Note: *The engine management system has a power hold function and remains powered for a period of time after you switch the ignition off. This is to allow diagnostic and adaptive tables to be stored. Disconnecting the battery without waiting can cause damage not covered by the vehicle Warranty.*

4. Disconnect and isolate the negative battery cable terminal.
5. Disconnect and isolate the positive battery cable terminal.
6. Remove the battery securing clamp.
7. Remove the battery.

If you disconnect or replace the vehicle battery, you must reset the following features:

- Window bounce-back. See **Window Bounce-Back** (page 121).
- Clock Settings.
- Pre-set radio stations.

Replacing the Battery

Note: *Before reconnecting the battery, make sure the ignition remains switched off.*

You must replace the battery with one of exactly the same specification.

To install, reverse the removal procedure.

Note: *Make sure that you correctly install the battery terminal covers, battery cover and battery cable terminals.*

RESETTING THE BATTERY SENSOR

When you install a new battery, reset the battery sensor by doing the following:

1. Switch the ignition on, and leave the engine off.

Note: *Complete Steps 2 and 3 within 10 seconds.*

2. Flash the high beam headlamps five times, ending with the high beams off.
3. Press and release the brake pedal three times.

The battery warning lamp flashes three times to confirm that the reset is successful.

RECYCLING AND DISPOSING OF THE 12V BATTERY



Make sure that you dispose of old batteries in an environmentally friendly way. Seek advice from your local authority about recycling old batteries.

Maintenance

12V BATTERY – TROUBLESHOOTING



If it illuminates while driving, it indicates a charging system error. Switch off all unnecessary electrical equipment and have your vehicle immediately checked.

12V BATTERY – WARNING LAMPS

12V BATTERY – INFORMATION MESSAGES

Message	Details
Charging System Service Soon	The charging system needs servicing. If this message stays on or continues to come on, have your vehicle checked as soon as possible.
Charging System Service Now	The charging system needs servicing. Have your vehicle immediately checked.
Turn Power Off To Save Battery	The battery management system determines that the battery is at a low state of charge. Switch the ignition off as soon as possible to protect the battery. This message clears when you start your vehicle and the battery state of charge has recovered. Switch off unnecessary electrical loads to allow for a faster battery state-of-charge recovery.
Electrical Power Saver Active Some Features Turned Off See Manual	Displays when the battery management system detects an extended low-voltage condition. The system disables various vehicle features to help preserve the battery. Switch off as many of the electrical loads as soon as possible to improve system voltage. When the system voltage recovers, the disabled features begin to operate as normal.

ADJUSTING THE HEADLAMPS

Vertical Aim Adjustment

The headlamps on your vehicle are properly aimed at the assembly plant. If your vehicle has been in an accident, have your vehicle checked as soon as possible.

Maintenance

Headlamp Aiming Target

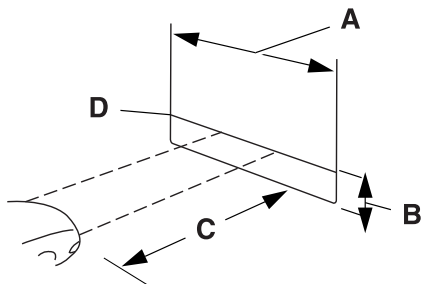

1. Park your vehicle directly in front of a wall or screen on a level surface, approximately 7.6 m (25 ft) away.
2. Measure the height from the center of your headlamp, indicated by a 3 millimeter circle on the lens, to the ground and mark an 2.4 m (8 ft) horizontal reference line on the vertical wall or screen at this height, a piece of masking tape works well.
3. Switch on the low beam headlamps to illuminate the wall or screen and open the hood. Cover one of the headlamps so no light hits the wall.

A 8 ft (2.4 m).

B Center height of lamp to ground.

C 25 ft (7.6 m).

D Horizontal reference line.

4. On the wall or screen, observe a light pattern with a distinct horizontal edge toward the right. If this edge is not at the horizontal reference line, adjust the beam so the edge is at the same height as the horizontal reference line.

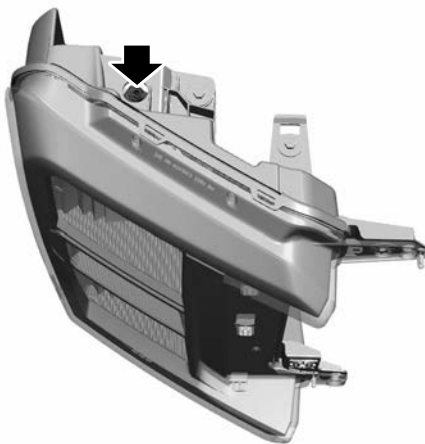

5. Locate the vertical adjuster on each headlamp. Using a Phillips #2 screwdriver, turn the adjuster either clockwise or counterclockwise to adjust the vertical aim of the headlamp.

Note: *Low/Mid series lamps: Use a Phillips #2 screwdriver to adjust.*

Maintenance

High Series Lamps: Use a 6 mm hex key or Phillips PH1 screwdriver to adjust.

- Repeat Steps 3 through 5 to adjust the other headlamp.

Note: *The vertical adjuster is in the same location for all headlamps.*

- Close the hood and turn off the lamps.

Horizontal Aim Adjustment

Horizontal aim is not required for this vehicle and is not adjustable.

EXTERIOR BULBS

EXTERIOR BULB SPECIFICATION CHART

Replacement bulbs are specified in the chart below. Headlamp bulbs must be marked with an authorized D.O.T. marking for North America to make sure they have the proper lamp performance, light brightness, light pattern and safe visibility. The correct bulbs will not damage the lamp assembly or void the lamp assembly warranty and will provide quality bulb illumination time.

Lamp	Specification	Power (Watt)
Headlamp. Low series.	H11L/9005LL	62/69
Headlamp. Mid/High series.	LED	LED
Front side marker lamp. Low series.	W5W	5
Front side marker lamp. Mid/High series.	LED	LED
Front fog lamp.	H11	62
Front fog lamp. ³	LED	LED
Front turn signal and parking lamp. Low series.	4257NA	30/7
Front turn signal and parking lamp. Mid/High series.	LED	LED
Rear lamp, brake lamp, and rear side marker lamp. Low/Mid series. ¹	3157K	27/7
Rear turn signal lamp. Low/Mid series. ¹	3175K	27/7
Rear lamp, brake lamp, rear turn signal, rear side marker lamp and reverse lamp. High series. ¹	LED	LED
Rear lamp, brake lamp, rear turn signal and rear side marker lamp. ²	3157K	27/7

Maintenance

Lamp	Specification	Power (Watt)
Reversing lamp. Low series.	WT21W	21
License plate lamp. Low series.	168	5
License plate lamp. High series.	LED	LED
Central high mounted cargo lamp.	912	12.8
Central high mounted cargo lamp.	LED	LED
Side turn signal and mirror clearance lamp.	LED	LED
Front clearance lamp.	LED	LED
Rear clearance lamp.	LED	LED
Front identification lamp.	LED	LED
Rear identification lamp.	LED	LED
Under hood lamp.	LED	LED

¹Pickup only.

²Chassis cab only.

³U.S. and Canada only

Note: LED lamps are not serviceable. See an authorized dealer if they fail.

Maintenance

REMOVING A REAR LAMP ASSEMBLY - CHASSIS CAB



1. Switch all of the lamps and the ignition off.
2. Remove the screws and the lamp lens from lamp assembly.
3. To install, reverse the removal procedure.

REMOVING A REAR LAMP ASSEMBLY - PICKUP

1. Make sure the headlamps are off.
2. Open the tailgate to access the rear lamp assemblies.

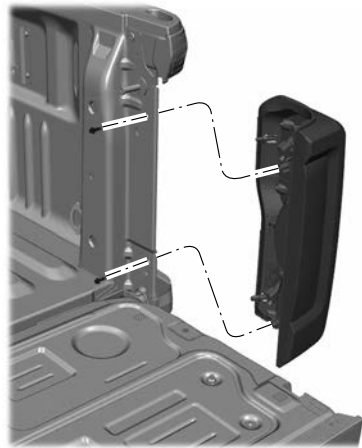

3. Remove the bolts from the tail lamp assembly.
4. Carefully pull the lamp assembly from the tailgate pillar by releasing the two retaining tabs.
5. To install, reverse the removal procedure.

CHANGING A HEADLAMP BULB



WARNING: Make sure the bulbs have cooled down before removing them. Failure to follow this warning could result in serious personal injury.

Note: To access the right-hand side bulbs, remove the air intake pipe. See **Changing the Engine Air Filter** (page 457).

For vehicles with diesel engines, to access the left-hand side bulbs, remove the washer reservoir filler tube.

Maintenance

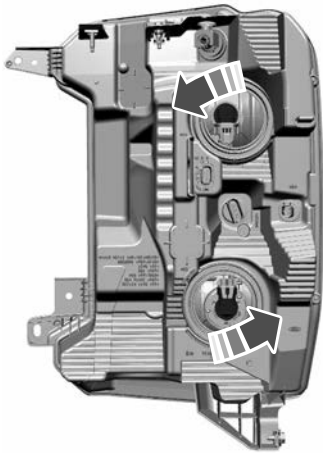

1. Switch all of the lamps and the ignition off.
2. Disconnect the electrical connector.
3. Turn the bulb holder counterclockwise and remove it.

Note: You cannot separate the bulb from the bulb holder.

4. To install, reverse the removal procedure.

Note: Handle a halogen headlamp bulb carefully and keep out of children's reach. Grasp the bulb only by its plastic base and do not touch the glass. The oil from your hand could cause the bulb to break the next time you operate the headlamps.

CHANGING A FRONT TURN SIGNAL LAMP BULB



WARNING: Make sure the bulbs have cooled down before removing them. Failure to follow this warning could result in serious personal injury.

Note: To access the right-hand side bulbs, remove the air intake pipe. See **Changing the Engine Air Filter** (page 457).

To access the left-hand side bulbs, remove the washer reservoir filler tube. Vehicles with diesel engine only.

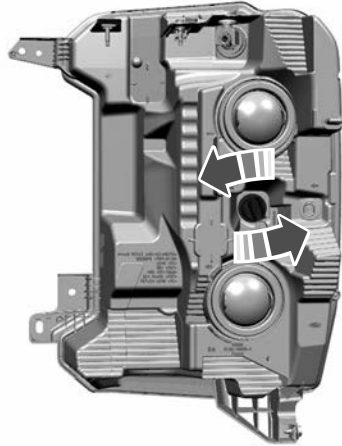

1. Switch all of the lamps and the ignition off.
2. Disconnect the electrical connector.
3. Turn the bulb holder counterclockwise and remove it.

Note: You cannot separate the bulb from the bulb holder.

4. To install, reverse the removal procedure.

Maintenance

CHANGING A FRONT FOG LAMP BULB

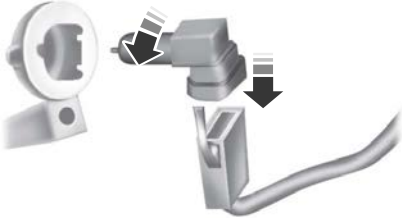

1. Make sure the fog lamps are off.
2. Disconnect the electrical connector from the fog lamp bulb.
3. Turn the bulb counterclockwise and remove it from the fog lamp.
4. To install, reverse the removal procedure.

CHANGING A REAR LAMP BULB

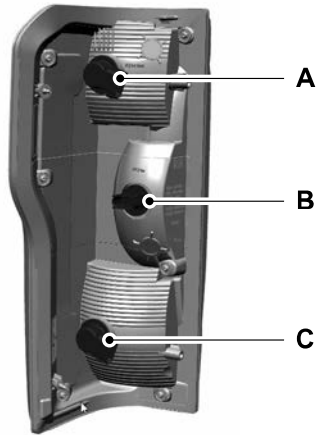

- A Stop lamp, rear lamp bulb, and turn signal lamp bulb.
- B Reversing lamp bulb.
- C Stop lamp, rear lamp bulb, and turn signal lamp bulb.

1. Remove the rear lamp assembly. See **Removing a Rear Lamp Assembly** (page 477).
2. Turn the bulb holder counterclockwise and remove it.
3. Remove the bulb by pulling it straight out.
4. To install, reverse the removal procedure.

Maintenance

CHANGING A STOPLAMP BULB

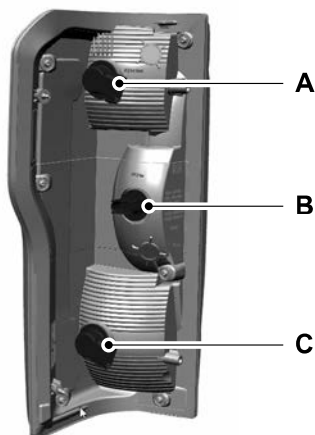

- A Stop lamp, rear lamp bulb, and turn signal lamp bulb.
- B Reversing lamp bulb.
- C Stop lamp, rear lamp bulb, and turn signal lamp bulb.

1. Remove the rear lamp assembly. See **Removing a Rear Lamp Assembly** (page 477).
2. Turn the bulb holder counterclockwise and remove it.
3. Remove the bulb by pulling it straight out.
4. To install, reverse the removal procedure.

CHANGING A REAR TURN SIGNAL LAMP BULB

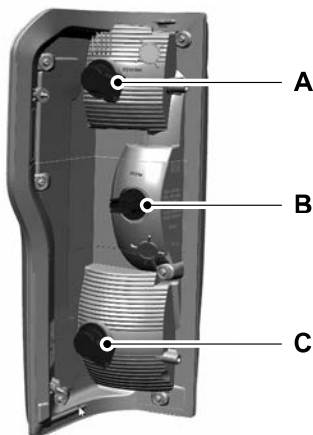

- A Stop lamp, rear lamp bulb, and turn signal lamp bulb.
- B Reversing lamp bulb.
- C Stop lamp, rear lamp bulb, and turn signal lamp bulb.

1. Remove the rear lamp assembly. See **Removing a Rear Lamp Assembly** (page 477).
2. Turn the bulb holder counterclockwise and remove it.
3. Remove the bulb by pulling it straight out.
4. To install, reverse the removal procedure.

Maintenance

CHANGING A REVERSING LAMP BULB

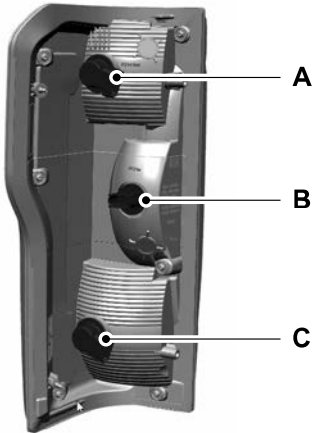

- A Stop lamp, rear lamp bulb, and Turn signal lamp bulb.
- B Reversing lamp bulb.
- C Stop lamp, rear lamp bulb, and Turn signal lamp bulb.

1. Remove the rear lamp assembly. See **Removing a Rear Lamp Assembly** (page 477).
2. Turn the bulb holder counterclockwise and remove it.
3. Remove the bulb by pulling it straight out.
4. To install, reverse the removal procedure.

CHANGING A HIGH MOUNTED STOPLAMP BULB

1. Make sure the lamps are off.

2. Remove the four screws and move the lamp assembly away from the vehicle to expose the bulb sockets.



3. Remove the bulb socket by rotating it counterclockwise and pulling it out of the lamp assembly.
4. Pull the bulb straight out of the socket.
5. To install, reverse the removal procedure.

CHANGING A LICENSE PLATE LAMP BULB

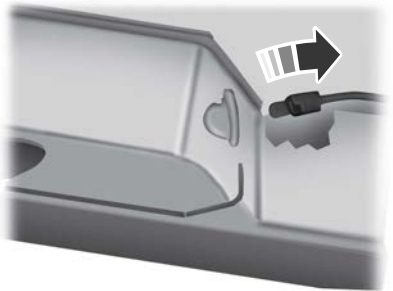

1. Switch all of the lamps and the ignition off.
2. To access the bulb, reach behind the bumper.
3. Turn the bulb holder counterclockwise and remove it.

Maintenance

4. Remove the bulb by pulling it straight out.
5. To install, reverse the removal procedure.

INTERIOR BULBS

INTERIOR BULB SPECIFICATION CHART

Your vehicle has LED lamps. These are not serviceable items. See an authorized dealer if they fail.

Vehicle Specifications

ENGINE SPECIFICATIONS - 6.7L DIESEL

Engine	6.7L V8 Diesel Engine
Displacement.	6,651 cm ³ (406 in ³)
Required fuel.	Ultra Low Sulfur Diesel up to B20
Firing order.	1-3-7-2-6-5-4-8
Compression ratio.	15.2:1

Vehicle Specifications

ENGINE SPECIFICATIONS - 6.8L, GASOLINE

Engine	6.8L V8
Cubic inches	415
Firing order	1-5-4-8-6-3-7-2
Ignition system	Coil on plug
Spark plug gap	1.3 mm (0.051 in)
Compression ratio	10.8:1

Vehicle Specifications

ENGINE SPECIFICATIONS - 7.3L, GASOLINE

Engine	7.3L V8 Engine
Displacement.	7,293 cm ³ (445 in ³)
Required fuel.	Minimum 87 octane
Firing order.	1-5-4-8-6-3-7-2
Ignition system.	Coil near spark plug with spark plug wire
Spark plug gap.	1.25 mm (0.049 in) - 1.35 mm (0.053 in)
Compression ratio.	10.5:1

Vehicle Specifications

MOTORCRAFT PARTS - 6.7L DIESEL

Component	Motorcraft Part Number
Air filter.	FA-2031
Foam pre-filter.	FA-1952
Battery (two required).	See note below. ¹
Cabin air filter.	FP-92
Engine oil filter. ²	FL-2124-S
Fuel filter.	FD-4625AA
Ten-speed automatic transmission fluid filter (10R140).	FT-221
Windshield wiper blades.	WW-2248-A

¹ See your dealer for the most current part number.

² If a Motorcraft oil filter is not available, use an oil filter that meets WSS-M99P55-D1.

We recommend Motorcraft® parts that are available at your authorized dealer or at www.fordparts.com. These parts are engineered for your vehicle, and meet or exceed our specifications. Use of other parts could impact vehicle performance, emissions and durability. Your warranty could be void for any damage related to use of other parts.

Vehicle Specifications

MOTORCRAFT PARTS - 6.8L, GASOLINE

Component	Motorcraft Part number
Air filter element.	FA-1950
One battery, two batteries (optional).	See note below. ¹
Cabin air filter.	FP-92
Engine oil filter. ²	FL-820-S
Spark plug.	SP-589
Transmission fluid filter.	FT-202
Windshield wiper blade.	WW-2248-A

¹ See your dealer for the most current part number.

² If a Motorcraft oil filter is not available, use an oil filter that aligns to SAE/USCAR – 36 Performance Specifications. Filter Type D.

We recommend Motorcraft parts that are available at your authorized dealer or at www.fordparts.com. These parts are engineered for your vehicle, and meet or exceed our specifications. Use of other parts could impact vehicle performance, emissions and durability. Your warranty could be void for any damage related to use of other parts.

Vehicle Specifications

MOTORCRAFT PARTS - 7.3L, GASOLINE

Component	Motorcraft Part Number
Air filter element.	FA-1950
One battery, two batteries (optional).	See note below. ¹
Cabin air filter.	FP-92
Engine oil filter. ²	FL-820-S
Spark plugs.	SP-589
Ten-speed automatic transmission fluid filter (1OR140).	FT-221
Windshield wiper blades.	WW-2248-A

¹ See your dealer for the most current part number.

² If a Motorcraft oil filter is not available, use an oil filter that aligns to SAE/USCAR – 36 Performance Specifications. Filter Type D.

We recommend Motorcraft parts that are available at your authorized dealer or at www.fordparts.com. We engineer these parts for your vehicle to meet or exceed our specifications. Use of other parts could impact vehicle performance, emissions and durability. Your warranty could be void for any damage related to use of other parts.

Vehicle Care

CLEANING PRODUCTS

Materials

For best results, use the following products

or products of equivalent quality:

For additional information and assistance, we recommend that you contact an authorized dealer.

Name	Specification
Motorcraft® Bug and Tar Remover, ZC-42 (U.S. & Canada)	
Motorcraft® Custom Bright Metal Cleaner, ZC-15 (U.S. & Canada)	ESR-M5B194-B
Motorcraft® Detail Wash, ZC-3-A (U.S. & Canada)	ESR-M14P4-A
Motorcraft® Engine Shampoo and Degreaser, ZC-20 (U.S.)	ESR-M14P3-A
Motorcraft® Engine Shampoo, CXC-66-A (Canada)	
Motorcraft® Premium Leather and Vinyl Cleaner, ZC-56 (U.S. & Canada)	
Motorcraft® Multi-Purpose Cleaner, CXC-101 (Canada)	
Motorcraft® Premium Windshield Wash Concentrate with Bitterant, ZC-32-B2 (U.S.)	WSS-M14P19-A
Motorcraft® Premium Quality Windshield Washer Fluid, CXC-37-F/M (Canada)	WSS-M14P19-A
Motorcraft® Professional Strength Carpet & Upholstery Cleaner, ZC-54 (U.S. & Canada)	
Motorcraft® Premium Glass Cleaner, CXC-100 (Canada)	ESR-M14P5-A
Motorcraft® Spot and Stain Remover, ZC-14 (U.S.)	
Motorcraft® Ultra-Clear Spray Glass Cleaner, ZC-23 (U.S.)	ESR-M14P5-A
Motorcraft® Wheel and Tire Cleaner, ZC-37-A (U.S. & Canada)	

Vehicle Care

CLEANING THE EXTERIOR

CLEANING THE EXTERIOR PRECAUTIONS

Immediately remove fuel spillages, additive residuals, bird droppings, insect deposits and road tar. These may damage your vehicle's paintwork or trim over time. Remove any exterior accessories, for example antennas, before entering a car wash.

Note: *If you intend to park your vehicle for an extended period after cleaning, drive it for few minutes before parking. This reduces the risk of corrosion of the brake discs, brake pads and linings.*

CLEANING HEADLAMPS AND REAR LAMPS

We recommend that you only use cold or lukewarm water containing car shampoo to clean the headlamps and the rear lamps.

Do not scrape the lamps.

Do not wipe lamps when they are dry.

CLEANING WINDOWS AND WIPER BLADES

To clean the windshield and wiper blades:

- Clean the windshield with a non-abrasive glass cleaner.

Note: *When cleaning the interior of the windshield, avoid getting any glass cleaner on the instrument panel or door panels. Wipe any glass cleaner off these surfaces immediately.*

- Clean the wiper blades with washer fluid or water applied with a soft sponge or cloth.

Note: *Do not use razor blades or other sharp objects to clean or remove decals from the inside of the heated rear window. This can cause damage not covered by the vehicle Warranty.*

Note: *We recommend cleaning the power sliding rear window at regular intervals to avoid dust and debris accumulation to deliver appropriate function.*

CLEANING CHROME, ALUMINIUM OR STAINLESS STEEL

We recommend that you only use a car shampoo, a soft cloth and water on bumpers and other chrome, aluminium or stainless steel parts.

Note: *For additional information and assistance, we recommend that you contact an authorized dealer.*

Note: *Rinse the area well after cleaning.*

Note: *Do not use abrasive materials, for example steel wool or plastic pads, as they can scratch these surfaces.*

Note: *Do not use chrome cleaner, metal cleaner or polish on wheels or wheel covers.*

CLEANING WHEELS

Only use a recommended wheel and tire cleaner to clean the wheels weekly. For additional information and assistance, contact an authorized dealer.

1. Use a sponge to remove heavy deposits of dirt and brake dust.
2. Rinse well after cleaning.

Note: *Do not apply a cleaning chemical to warm or hot wheel rims and covers.*

Vehicle Care

If you intend on parking your vehicle for an extended period after cleaning the wheels with a wheel cleaner, drive your vehicle for a few minutes before parking your vehicle. This reduces the risk of corrosion of the brake discs, brake pads and linings.

Do not clean the wheels when they are hot.

Note: *Some car washes could damage wheel rims and covers.*

Note: *Using non-recommended cleaners, harsh cleaning products, chrome wheel cleaners or abrasive materials could damage wheel rims and covers.*

Cleaning Running Boards

We recommend that you clean your running boards in the following way:

1. Use a clean, soft, non-abrasive sponge or brush to remove heavy deposits of dirt.
2. Allow the cleaner to sit on the running board surface for the time specified. Rinse thoroughly with cold water.
3. For additional information and assistance, contact an authorized dealer.

Note: *Do not leave the cleaner on longer than the recommended wait time. This could damage the running boards.*

Note: *Do not allow the cleaner to dry unless instructed.*

Note: *Some car washes could damage the running boards.*

Note: *Using non-recommended cleaners, harsh cleaning products, chrome wheel cleaners or abrasive materials could damage the running boards.*

CLEANING THE ENGINE COMPARTMENT

Use a vacuum cleaner to remove debris from the screen area below the windshield.

Note: *If you are not familiar with the parts around the engine do not wash the engine compartment. Avoid frequent engine washes.*

When washing the engine compartment:

- Never wash or rinse the engine while it is hot or running.
- Never wash or rinse any ignition coil, spark plug wire or spark plug well.
- Cover the battery, power distribution box, and air filter assembly to prevent water damage.

Note: *If your vehicle has an engine cover remove the cover before application of shampoo and degreaser.*

- Spray an approved engine shampoo and degreaser on all parts that require cleaning and rinse with water.

Note: *Follow the manufacturer's instructions for using engine shampoo and degreaser.*

CLEANING STRIPES OR GRAPHICS

It is recommended to wash your vehicle by hand however, pressure washing may be used under the following conditions:

- Use a spray with a minimum of 40° wide spray angle pattern.
- Keep the nozzle 30 cm (12 in) and at a 90° angle to your vehicle.
- Do not use water pressure higher than 6,895 kPa (1,000 psi).
- Do not use water hotter than 23°C (73°F).

Note: *Holding the pressure washer nozzle at an angle to the vehicle's surface may damage graphics and cause the edges to peel away.*

Vehicle Care

CLEANING CAMERA LENSES AND SENSORS

We recommend that you only use lukewarm or cold water and a soft cloth to clean the camera lens and sensors.

Note: Do not pressure wash camera lens and sensors.

CLEANING THE UNDERBODY

Flush the complete underside of your vehicle frequently. Keep body and door drain holes free from packed dirt.

Rear suspension components may require regular cleaning with a power washer or a thorough rinse with a strong stream of water if the vehicle is operated in dusty or muddy environments. Rear leaf springs or other suspension components may emit squeaking or popping noises while operating the vehicle if particles, such as dirt, rocks, or other debris, are present in the components.

CLEANING THE EXHAUST

WARNING: Do not modify or remove the exhaust tailpipe. Blocked holes may result in increased exhaust gas temperatures, vehicle damage, property damage or personal injury.

WARNING: Failure to keep the holes in the exhaust tailpipe clean and free of debris or foreign material may result in blocked holes. Blocked holes may result in increased exhaust gas temperatures, vehicle damage, property damage or personal injury.

WARNING: The normal operating temperature of the exhaust system is very high. Never work around or attempt to repair any part of the exhaust system until it has cooled. Use special care when working around the diesel oxidation catalytic converter or the diesel particulate filter. The diesel oxidation catalytic converter and the diesel particulate filter heat up to very high temperatures after only a short period of engine operation and remain hot after you switch the engine off.

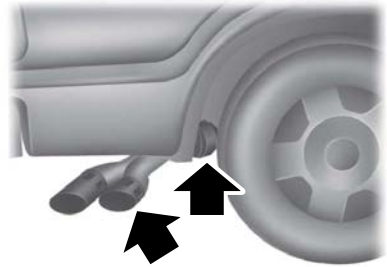

The visible holes in the exhaust tip and the holes under the shield just inboard of the right rear tire(s) are functional. Keep the holes clear of mud, debris or foreign material to maintain proper function of the exhaust system. Clean and remove debris or foreign material if present as needed. Spraying with a hose during regular washing of vehicle should help keep holes clean and clear of debris or foreign material.

Vehicle Care

CLEANING THE INTERIOR

CLEANING THE INSTRUMENT PANEL



WARNING: Do not use chemical solvents or strong detergents when cleaning the steering wheel or instrument panel to avoid contamination of the airbag system.

We recommend that you only clean the instrument panel and cluster lens with a damp soft cloth. Dry the area with a clean, soft cloth.

For additional information and assistance, we recommend that you contact an authorized dealer.

Note: Avoid cleaners or polishes that increase the gloss of the upper portion of the instrument panel. The dull finish in this area helps protect you from undesirable windshield reflection.

CLEANING PLASTIC

We recommend that you only use a mild soap and water solution on a soft cloth. Dry the area with a clean, soft cloth.

CLEANING DISPLAYS AND SCREENS

We recommend that you only use a microfiber cloth in a circular motion to clean off the fingerprint or dust.

Note: Do not pour or spray alcohol onto the touchscreen.

Note: Do not use detergent or any type of solvent to clean the touchscreen.

CLEANING FABRIC



WARNING: On vehicles equipped with seat-mounted airbags, do not use chemical solvents or strong detergents. Such products could contaminate the side airbag system and affect performance of the side airbag in a crash.

We recommend that you only clean fabric in the following way:

1. Remove dust and loose dirt with a vacuum cleaner.
2. Wipe the surface with a soft, damp cloth and a mild soap and water solution. Dry the area with a clean, soft cloth.
3. For additional information and assistance, we recommend that you contact an authorized dealer.

For heavy stains, spot clean the area. If a ring forms on the fabric, clean the entire area immediately, but do not oversaturate or the ring could set.

CLEANING LEATHER



WARNING: On vehicles equipped with seat-mounted airbags, do not use chemical solvents or strong detergents. Such products could contaminate the side airbag system and affect performance of the side airbag in a crash.

We recommend that you only clean the leather surfaces in the following way:

1. Remove dust and loose dirt with a vacuum cleaner.
2. Wipe the surface with a soft, damp cloth and a mild soap and water solution. Dry the area with a clean, soft cloth.

Vehicle Care

3. Make sure the leather is dry, then apply a small amount of conditioner to a clean, dry cloth.
 4. Rub the conditioner into the leather until it disappears. Allow the conditioner to dry, then repeat the process for the entire interior. If a film appears, wipe it off with a dry, clean cloth.
 5. For additional information and assistance, we recommend that you contact an authorized dealer.
2. Wipe the surface with a soft, damp cloth and a mild soap and water solution. Dry the area with a clean, soft cloth.
 3. For additional information and assistance, we recommend that you contact an authorized dealer.

For heavy stains, spot clean the area. If a ring forms on the fabric, clean the entire area immediately, but do not oversaturate or the ring could set.

We recommend that you only clean your floor mats in the following way:

1. Remove dust and loose dirt with a vacuum cleaner.
2. Wash rubber floor mats using mild soap and lukewarm or cold water.
3. Completely dry the floor mat before placing them back in your vehicle.

CLEANING VINYL



WARNING: On vehicles equipped with seat-mounted airbags, do not use chemical solvents or strong detergents. Such products could contaminate the side airbag system and affect performance of the side airbag in a crash.

We recommend that you only clean vinyl surfaces in the following way:

1. Remove dust and loose dirt with a vacuum cleaner.
2. Wipe the surface with a soft, damp cloth and a mild soap and water solution. Dry the area with a clean, soft cloth.
3. For additional information and assistance, we recommend that you contact an authorized dealer.

CLEANING SEATBELTS



WARNING: Do not use cleaning solvents, bleach or dye on the vehicle's seatbelts, as these actions may weaken the belt webbing.

1. Wipe the surface with a soft, damp cloth and a mild soap and water solution. Dry the area with a clean, soft cloth.

CLEANING CARPETS AND FLOOR MATS

We recommend that you only clean your carpets in the following way:

1. Remove dust and loose dirt with a vacuum cleaner.

CLEANING GLASS ROOF TRACKS

1. Remove debris from the tracks with a vacuum cleaner.
2. Wipe the bulb seal and mating painted roof metal surface with a soft, damp cloth and a mild soap and water solution.

Note: *The glass roof rail tracks are greased to maintain proper functionality. Do not wipe off the grease.*

Vehicle Care

REPAIRING MINOR PAINT DAMAGE

We recommend that you contact an authorized dealer to identify your vehicle color code. Authorized dealers have touch-up paint to match your vehicle's color.

Before repairing minor paint damage, use a cleaner to remove particles such as bird droppings, tree sap, insect deposits, tar spots, road salt and industrial fallout.

Read the instructions before using cleaning products.

WAXING YOUR VEHICLE

Wax the high-gloss painted surface of your prewashed vehicle once or twice a year.

We recommend that you only use an approved quality wax that does not contain abrasives. Follow the manufacturer's instructions to apply and remove the wax. For additional information and assistance, we recommend that you contact an authorized dealer.

When washing and waxing, park your vehicle in a shaded area out of direct sunlight.

Note: *Avoid waxing unpainted or low-gloss black colored parts, they discolor over time.*

VEHICLE CARE VIDEOS

[PVD "Chrome like" wheel and general wheel care Video Link](#)

[Chrome Care Video Link](#)

Storing Your Vehicle

PREPARING YOUR VEHICLE FOR STORAGE

If you plan on storing your vehicle for 30 days or more, the following maintenance recommendations makes sure your vehicle stays in good operating condition.

Under various conditions, long-term storage may lead to degraded engine performance or failure unless you use specific precautions to preserve your vehicle.

General

- Store all vehicles in a dry, ventilated place.
- If vehicles are stored outside, they require regular maintenance to protect against rust and weather damage.
- Make sure all linkages, cables, levers and pins under your vehicle are covered with grease to prevent rust.
- Move vehicles at least 7.5 m (25 ft) every 15 days to lubricate working parts and prevent corrosion.
- Fill the fuel tank with high-quality fuel until the first automatic shutoff of the fuel pump nozzle.

Engine

- Change the engine oil and filter prior to storage because used engine oil contains contaminants which may cause engine damage.
- Start the engine every 15 days for a minimum of 15 minutes. Run at fast idle with the climate controls set to defrost until the engine reaches normal operating temperature.
- With your foot on the brake, shift through all the gears while the engine is running.

Body

- Wash your vehicle thoroughly to remove dirt, grease, oil, tar or mud from exterior surfaces, rear wheel housings and the underside of front fenders.
- Periodically wash your vehicle if it is stored in exposed locations.
- Touch-up exposed or primed metal to prevent rust.
- Cover chrome and stainless steel parts with a thick coat of auto wax to prevent discoloration. Rewax as necessary when you wash your vehicle.
- Lubricate all hood, door and luggage compartment hinges and latches with a light grade oil.
- Cover interior trim to prevent fading.
- Keep all rubber parts free from oil and solvents.

12 Volt Battery

- When storing your vehicle for longer than 30 days the battery state of charge should be approximately 50%. Additionally, we recommend to disconnect the 12v battery to reduce system loads on the battery, or you can use a trickle charger for longer storage periods.
- Check and recharge as necessary. Keep connections clean.

Note: *It is necessary to reset memory features if you disconnect the battery cables.*

Storing Your Vehicle

Tires

- Maintain recommended air pressure.
- To minimize flat spots on the tires, inflate all four tires to the recommended cold pressures listed on the Safety Compliance Certification label or Tire Label affixed to your vehicle. When the vehicle is taken out of storage, reset the tire pressures as necessary to the recommended levels listed on the Safety Compliance Certification label or Tire Label affixed to your vehicle.

Note: *If you store your vehicle in a location with low ambient temperatures, follow the instructions for care of summer tires.*

Brakes

Make sure the brakes and parking brake fully release.

Note: *If you intend to park your vehicle for an extended period after cleaning, drive it for few minutes before parking. This reduces the risk of corrosion of the brake discs, brake pads and linings.*

- Check the exhaust for any foreign materials.
- Check tire pressures and set tire inflation per the Tire Label.
- Check brake pedal operation. Corroded brake rotors could cause brake noise. Drive your vehicle and gently apply and release the brakes repeatedly over a 10-minute drive to reduce the corrosion from the brakes.
- Check fluid levels (including coolant, oil and gas) to make sure there are no leaks, and fluids are at recommended levels.
- If you remove the battery, clean the battery cable ends and check for damage.

Contact an authorized dealer if you have any concerns or issues.

REMOVING YOUR VEHICLE FROM STORAGE

When your vehicle is ready to come out of storage, do the following:

- We recommend that you change the engine oil before you use your vehicle again.
- Wash your vehicle to remove any dirt or grease film build-up on window surfaces.
- Check windshield wipers for any deterioration.
- Check the underhood for any foreign materials such as mice or squirrel nests.

Wheel and Tire Information

LOCATING THE TIRE LABEL

You will find a Tire Label containing tire inflation pressure by tire size and other important information located on the B-Pillar or the edge of the driver's door. See **Locating the Safety Compliance Certification Labels** (page 352).

DEPARTMENT OF TRANSPORTATION UNIFORM TIRE QUALITY GRADES



Tire Quality Grades apply to new pneumatic passenger car tires. The Quality grades can be found where applicable on the tire sidewall between tread shoulder and maximum section width. For example: **Treadwear 200 Traction AA Temperature A.**

These Tire Quality Grades are determined by standards that the United States Department of Transportation has set.

Tire Quality Grades apply to new pneumatic passenger car tires. They do not apply to deep tread, winter-type snow tires, space-saver or temporary use spare tires, light truck or LT type tires, tires with nominal rim diameters of 10 to 12 inches or limited production tires as defined in Title 49 Code of Federal Regulations Part 575.104 (c)(2).

U.S. Department of Transportation Tire quality grades: The U.S. Department of Transportation requires us to give you the following information about tire grades exactly as the government has written it.

Treadwear

The treadwear grade is a comparative rating based on the wear rate of the tire when tested under controlled conditions on a specified government test course. For example, a tire graded 150 would wear 1½ times as well on the government course as a tire graded 100. The relative performance of tires depends upon the actual conditions of their use, however, and may depart significantly from the norm due to variations in driving habits, service practices, and differences in road characteristics and climate.

Wheel and Tire Information

Traction AA A B C



WARNING: The traction grade assigned to this tire is based on straight-ahead braking traction tests, and does not include acceleration, cornering, hydroplaning or peak traction characteristics.

The traction grades, from highest to lowest are AA, A, B, and C. The grades represent the tire's ability to stop on wet pavement as measured under controlled conditions on specified government test surfaces of asphalt and concrete. A tire marked C may have poor traction performance.

Temperature A B C



WARNING: The temperature grade for this tire is established for a tire that is properly inflated and not overloaded. Excessive speed, underinflation, or excessive loading, either separately or in combination, can cause heat buildup and possible tire failure.

The temperature grades are A (the highest), B and C, representing the tire's resistance to the generation of heat and its ability to dissipate heat when tested under controlled conditions on a specified indoor laboratory

test wheel. Sustained high temperature can cause the material of the tire to degenerate and reduce tire life, and excessive temperature can lead to sudden tire failure. The grade C corresponds to a level of performance which all passenger car tires must meet under the Federal Motor Vehicle Safety Standard No. 139. Grades B and A represent higher levels of performance on the laboratory test wheel than the minimum required by law.

INFORMATION ON THE TIRE SIDEWALL

Both United States and Canada Federal regulations require tire manufacturers to place standardized information on the sidewall of all tires. This information identifies and describes the fundamental characteristics of the tire and also provides a U.S. DOT Tire Identification Number for safety standard certification and in case of a recall.

Wheel and Tire Information

Information on P Type Tires

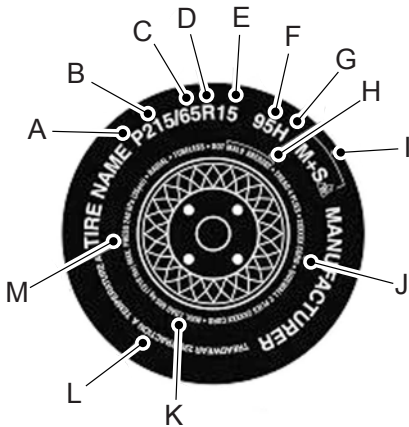

P215/65R15 95H is an example of a tire size, load index and speed rating. The definitions of these items are listed below. (Note that the tire size, load index and speed rating for your vehicle may be different from this example.)

A. **P:** Indicates a tire, designated by the Tire and Rim Association, that may be used for service on cars, sport utility vehicles, minivans and light trucks. **Note:** If your tire size does not begin with a letter this may mean it is designated by either the European Tire and Rim Technical Organization or the Japan Tire Manufacturing Association.

B. **215:** Indicates the nominal width of the tire in millimeters from sidewall edge to sidewall edge. In general, the larger the number, the wider the tire.

C. **65:** Indicates the aspect ratio which gives the tire's ratio of height to width.

D. **R:** Indicates a radial type tire.

E. **15:** Indicates the wheel or rim diameter in inches. If you change your wheel size, you will have to purchase new tires to match the new wheel diameter.

F. **95:** Indicates the tire's load index. It is an index that relates to how much weight a tire can carry. You may find this information in your owner's manual. If not, contact a local tire dealer.

Note: You may not find this information on all tires because it is not required by federal law.

G. **H:** Indicates the tire's speed rating. The speed rating denotes the speed at which a tire is designed to be driven for extended periods of time under a standard condition of load and inflation pressure. The tires on your vehicle may operate at different conditions for load and inflation pressure. These speed ratings may need to be adjusted for the difference in conditions. The ratings range from 130 km/h (81 mph) to 300 km/h (186 mph). These ratings are listed in the following chart.

Wheel and Tire Information

Note: You may not find this information on all tires because it is not required by federal law.

Letter rating	Speed rating
M	130 km/h (81 mph)
N	140 km/h (87 mph)
Q	160 km/h (99 mph)
R	170 km/h (106 mph)
S	180 km/h (112 mph)
T	190 km/h (118 mph)
U	200 km/h (124 mph)
H	210 km/h (130 mph)
V	240 km/h (149 mph)
W	270 km/h (168 mph)
Y	300 km/h (186 mph)

Note: For tires with a maximum speed capability over 149 mph (240 km/h), tire manufacturers sometimes use the letters ZR. For those with a maximum speed capability over 186 mph (299 km/h), tire manufacturers always use the letters ZR.

H. U.S. DOT Tire Identification Number (TIN): This begins with the letters DOT and indicates that the tire meets all federal standards. The next two numbers or letters are the plant code designating where it was manufactured, the next two are

the tire size code and the last four numbers represent the week and year the tire was built. For example, the numbers 317 mean the 31st week of 1997. After 2000, the numbers go to four digits. For example, 2501 means the 25th week of 2001. The numbers in between are identification codes used for traceability. This information is used to contact customers if a tire defect requires a recall.

I. M+S or M/S: Mud and Snow, or
AT: All Terrain, or
AS: All Season.

J. Tire Ply Composition and Material Used: Indicates the number of plies or the number of layers of rubber-coated fabric in the tire tread and sidewall. Tire manufacturers also must indicate the ply materials in the tire and the sidewall, which include steel, nylon, polyester, and others.

K. Maximum Load: Indicates the maximum load in kilograms and pounds that can be carried by the tire. See the Safety Compliance Certification Label (affixed to either the door hinge pillar, door-latch post, or the door edge that meets the door-latch post, next to the driver's seating position), for the correct tire pressure for your vehicle.

L. Treadwear, Traction and Temperature Grades:

Wheel and Tire Information

***Treadwear:** The treadwear grade is a comparative rating based on the wear rate of the tire when tested under controlled conditions on a specified government test course. For example, a tire graded 150 would wear one and one-half times as well on the government course as a tire graded 100.

***Traction:** The traction grades, from highest to lowest are AA, A, B, and C. The grades represent the tire's ability to stop on wet pavement as measured under controlled conditions on specified government test surfaces of asphalt and concrete. A tire marked C may have poor traction performance.

***Temperature:** The temperature grades are A (the highest), B and C, representing the tire's resistance to the generation of heat and its ability to dissipate heat when tested under controlled conditions on a specified indoor laboratory test wheel.

M. Maximum Inflation

Pressure: Indicates the tire manufacturers' maximum permissible pressure or the pressure at which the maximum load can be carried by the tire. This pressure is normally higher than the vehicle manufacturer's recommended cold inflation pressure which can be found on the Safety Compliance Certification Label (affixed to either the door hinge pillar,

door-latch post, or the door edge that meets the door-latch post, next to the driver's seating position), or Tire Label which is located on the B-Pillar or the edge of the driver's door. The cold inflation pressure should never be set lower than the recommended pressure on the vehicle label.

The tire suppliers may have additional markings, notes or warnings such as standard load or radial tubeless.

Additional Information Contained on the Tire Sidewall for LT Type Tires

Note: *Tire Quality Grades do not apply to this type of tire.*

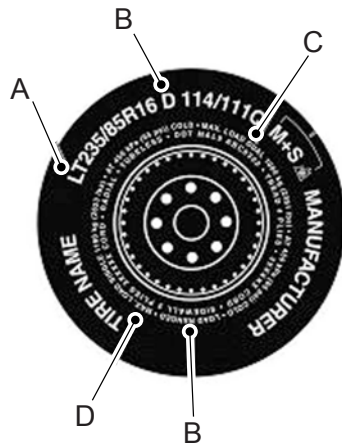

Wheel and Tire Information

LT type tires have some additional information beyond those of P type tires; these differences are described below.

A. **LT:** Indicates a tire, designated by the Tire and Rim Association, that is intended for service on light trucks.

B. **Load Range and Load Inflation Limits:** Indicates the tire's load-carrying capabilities and its inflation limits.

C. **Maximum Load Dual lb (kg) at psi (kPa) cold:** Indicates the maximum load and tire pressure when the tire is used as a dual, defined as four tires on the rear axle (a total of six or more tires on the vehicle).

D. **Maximum Load Single lb (kg) at psi (kPa) cold:** Indicates the maximum load and tire pressure when the tire is used as a single, defined as two tires (total) on the rear axle.

Information on T Type Tires

T145/80D16 is an example of a tire size.

Note: *The temporary tire size for your vehicle may be different from this example. Tire Quality Grades do not apply to this type of tire.*

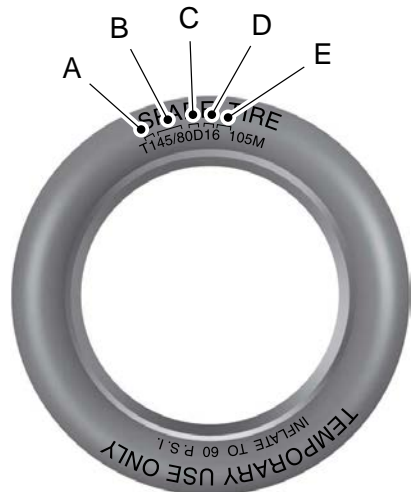

T type tires have some additional information beyond those of P type tires; these differences are described below:

A. **T:** Indicates a type of tire, designated by the Tire and Rim Association, that is intended for temporary service on cars, sport utility vehicles, minivans and light trucks.

B. **145:** Indicates the nominal width of the tire in millimeters from sidewall edge to sidewall edge. In general, the larger the number, the wider the tire.

Wheel and Tire Information

C. **80:** Indicates the aspect ratio which gives the tire's ratio of height to width. Numbers of 70 or lower indicate a short sidewall.

D. **D:** Indicates a diagonal type tire.

R: Indicates a radial type tire.

E. **16:** Indicates the wheel or rim diameter in inches. If you change your wheel size, you will have to purchase new tires to match the new wheel diameter.

GLOSSARY OF TIRE TERMINOLOGY

***Tire label:** A label showing the original equipment tire sizes, recommended inflation pressure and the maximum weight the vehicle can carry.

***Tire Identification Number (TIN):** A number on the sidewall of each tire providing information about the tire brand and manufacturing plant, tire size and date of manufacture. Also referred to as DOT code.

***Inflation pressure:** A measure of the amount of air in a tire.

***Standard load:** A class of P-metric or Metric tires designed to carry a maximum load at set pressure. For example: For P-metric tires 2.4 bar (35 psi) and for Metric tires 2.5 bar (36 psi). Increasing the inflation pressure beyond this pressure will not increase the tire's load carrying capability.

***Extra load:** A class of P-metric or Metric tires designed to carry a heavier maximum load at 2.9 bar (42 psi). Increasing the inflation pressure beyond this pressure will not increase the tire's load carrying capability.

***kPa:** Kilopascal, a metric unit of air pressure.

***PSI:** Pounds per square inch, a standard unit of air pressure.

***Cold tire pressure:** The tire pressure when the vehicle has been stationary and out of direct sunlight for an hour or more and prior to the vehicle being driven for 1.6 km (1 mi).

***Recommended inflation pressure:** The cold inflation pressure found on the Safety Compliance Certification Label (affixed to either the door hinge pillar, door-latch post, or the door edge that meets the door-latch post, next to the driver's seating position), or Tire Label located on the B-Pillar or the edge of the driver door.

***B-pillar:** The structural member at the side of the vehicle behind the front door.

***Bead area of the tire:** Area of the tire next to the rim.

***Sidewall of the tire:** Area between the bead area and the tread.

Wheel and Tire Information

***Tread area of the tire:** Area of the perimeter of the tire that contacts the road when mounted on the vehicle.

***Rim:** The metal support (wheel) for a tire or a tire and tube assembly upon which the tire beads are seated.

TIRE REPLACEMENT REQUIREMENTS

AGE



WARNING: Tires degrade over time depending on many factors such as weather, storage conditions, and conditions of use (load, speed, inflation pressure) the tires experience throughout their lives.

In general, tires should be replaced after six years regardless of tread wear. However, heat caused by hot climates or frequent high loading conditions can accelerate the aging process and may require tires to be replaced more frequently.

You should replace your spare tire when you replace the road tires or after six years due to aging even if it has not been used.

U.S. DOT Tire Identification Number

Both United States and Canada Federal regulations require tire manufacturers to place standardized information on the sidewall of all tires. This information identifies and describes the fundamental characteristics of the tire and also provides a U.S. DOT Tire Identification Number for safety standard certification and in case of a recall.

This begins with the letters DOT and indicates that the tire meets all federal standards. The next two numbers or letters are the plant code designating where it was manufactured, the next two are the tire size code and the last four numbers represent the week and year the tire was built. For example, the numbers 317 mean the 31st week of 1997. After 2000, the numbers go to four digits. For example, 2501 means the 25th week of 2001. The numbers in between are identification codes used for traceability. This information is used to contact customers if a tire defect requires a recall.

Tire Replacement Requirements

Your vehicle is equipped with tires designed to provide a safe ride and handling capability.

Wheel and Tire Information



WARNING: Only use replacement tires and wheels that are the same size, load index, speed rating and type (such as P-metric versus LT-metric or all-season versus all-terrain) as those originally provided by Ford. The recommended tire and wheel size may be found on either the Safety Compliance Certification Label (affixed to either the door hinge pillar, door-latch post, or the door edge that meets the door-latch post, next to the driver's seating position), or the Tire Label which is located on the B-Pillar or edge of the driver's door. If this information is not found on these labels, then you should contact your authorized dealer as soon as possible. Use of any tire or wheel not recommended by Ford can affect the safety and performance of your vehicle, which could result in an increased risk of loss of vehicle control, vehicle rollover, personal injury and death.



WARNING: To reduce the risk of serious injury, when mounting replacement tires and wheels, you should not exceed the maximum pressure indicated on the sidewall of the tire to set the beads without additional precautions listed below. If the beads do not seat at the maximum pressure indicated, re-lubricate and try again.



WARNING: For a mounting pressure more than 1.38 bar (20 psi) greater than the maximum pressure, a Ford dealer or other tire service professional should do the mounting.



WARNING: Always inflate steel carcass tires with a remote air fill with the person inflating standing at a minimum of 3.66 m (12 ft) away from the wheel and tire assembly.



WARNING: When inflating the tire for mounting pressures up to 1.38 bar (20 psi) greater than the maximum pressure on the tire sidewall, the following precautions must be taken to protect the person mounting the tire:

- Make sure that you have the correct tire and wheel size.
- Lubricate the tire bead and wheel bead seat area again.

Wheel and Tire Information

- Stand at a minimum of 3.66 m (12 ft) away from the wheel and tire assembly.
- Use both eye and ear protection.

Important: Remember to replace the wheel valve stems when the road tires are replaced on your vehicle.

It is recommended that the two front tires or two rear tires generally be replaced as a pair if the worn tires still have usable depth.

To avoid potential Four-Wheel Drive (4WD) malfunction or (4WD) system damage, it is recommended to replace all four tires rather than mixing significantly worn tires with new tires.

The tire pressure sensors mounted in the wheels (originally installed on your vehicle) are not designed to be used in aftermarket wheels.

The use of wheels or tires not recommended may affect the operation of your tire pressure monitoring system.

If the tire pressure monitoring system indicator is flashing, your system is malfunctioning. Your replacement tire might be incompatible with your tire pressure monitoring system, or some component of the system may be damaged.

Tire can be damaged during off-road use, so inspection after off-road use is also recommended.

Replacing a Tire That Is Greenhouse Gas Certified

The tires installed on this vehicle at the factory as original equipment are certified for Greenhouse Gas and Fuel Efficiency regulations. Replacement tires must be of equal or lower rolling resistance level (TRRL or Crr). Consult with your tire supplier(s) for appropriate replacement tires.

USING SNOW CHAINS

 **WARNING:** Do not exceed 50 km/h (30 mph). Failure to follow this instruction could result in the loss of control of your vehicle, personal injury or death.

 **WARNING:** Do not use snow chains on snow-free roads.

 **WARNING:** Only fit snow chains to specified tires.

 **WARNING:** If your vehicle is fitted with wheel trims, remove them before fitting snow chains.

 **WARNING:** Wheels and tires must be the same size, load index and speed rating as those originally fitted on the vehicle. Use of any other tire or wheel can affect the safety and performance of your vehicle. Additionally, the use of non-recommended tires and wheels can

Wheel and Tire Information

cause steering, suspension, axle, transfer case or power transfer unit failure. Follow the recommended tire inflation pressures found on the Safety Compliance Certification label, or the Tire Label on the B-Pillar or the edge of the driver door. Failure to follow this instruction could result in loss of vehicle control, vehicle rollover, or personal injury or death.

Note: Do not use snow chains on vehicles with LT275/65R20 or LT 285/75R18 sized tires.

Note: The suspension insulation and bumpers will help prevent vehicle damage. Do not remove these components from your vehicle when using snow tires and chains.

The tires on your vehicle have all-weather treads to provide traction in rain and snow. However, in some climates, you may need to use snow tires and cables. If you need to use cables, we recommend that you use steel wheels of the same size and specification, as cables may chip aluminum wheels.

Follow these guidelines when using snow tires and chains:

- If possible, avoid fully loading your vehicle.
- Use only SAE Class S chains.
- Install chains securely, verifying that the chains do not touch any wiring, brake lines or fuel lines.
- Only install snow chains on the rear axle.
- For Dual Rear Wheel (DRW) vehicles, only install snow chains on the outer wheel of each pair.
- Drive cautiously. If you hear the chains rub or bang against your vehicle, stop and retighten the chains. If this does not work, remove the chains to prevent damage to your vehicle.
- Remove the tire chains when you no longer need them. Do not use tire chains on dry roads.

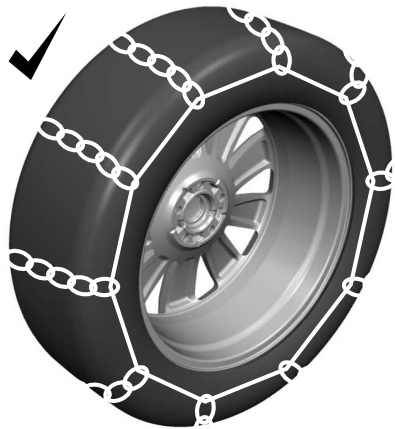
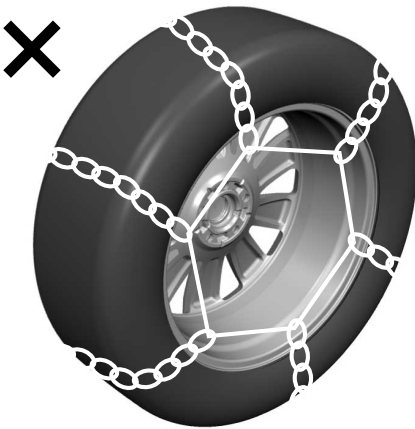

Wheel and Tire Information

Use snow chains that fit against the sidewall of the tire to prevent the chains from touching the wheel rims or suspension. Refer to the previous illustration.

If you have any questions regarding snow chains, please contact your authorized dealer.

Tire Care

CHECKING THE TIRE PRESSURES

Safe operation of your vehicle requires that your tires are properly inflated. Every day before you drive, check your tires.

At least once a month and before long trips, inspect each tire and check the tire pressure with a tire gauge. Inflate all tires to the recommended inflation pressure. See **Inflating the Tires** (page 510).

INFLATING THE TIRES



WARNING: Under-inflation is the most common cause of tire failures and may result in severe tire cracking, tread separation or blowout, with unexpected loss of vehicle control and increased risk of injury. Under-inflation increases sidewall flexing and rolling resistance, resulting in heat buildup and internal damage to the tire. It also may result in unnecessary tire stress, irregular wear, loss of vehicle control and accidents. A tire can lose up to half of its air pressure and not appear to be flat!

Use the recommended cold inflation pressure for optimum tire performance and wear. Under-inflation or over-inflation may cause uneven treadwear patterns.

Always inflate your tires to the recommended inflation pressure even if it is less than the maximum inflation pressure information found on the tire. You will find a Tire Label containing the manufacturer's recommended tire inflation pressure by the tire size and other important information located on the B-Pillar or the edge of the driver door.

The recommended tire inflation pressure is also found on the Safety Compliance Certification Label, affixed to either the door hinge pillar, door-latch post, or the door edge that meets the door-latch on the B-pillar, or on the edge of the driver door.

Failure to follow the tire pressure recommendations can cause uneven treadwear patterns and adversely affect the way your vehicle handles.

Note: *If you have to drive a distance to get air for your tire(s), check and record the tire pressure first and add the appropriate air pressure when you get to the pump. It is normal for tires to heat up and the air pressure inside to go up as you drive.*

To check the pressure in your tire(s):

Tire Care

1. Make sure the tires are cool, meaning they are not hot from driving even a mile.

Note: *If you are checking tire pressure when the tire is hot, (for example, driven more than 1 mile [1.6 kilometers]), never bleed or reduce air pressure. The tires are hot from driving and it is normal for pressures to increase above recommended cold pressures. A hot tire at or below recommended cold inflation pressure could be significantly under-inflated.*

2. Remove the cap from the valve on one tire, then firmly press the tire gauge onto the valve and measure the pressure.

3. Add enough air to reach the recommended air pressure.

Note: *If you overfill the tire, release air by pressing on the metal stem in the center of the valve. Then recheck the pressure with your tire gauge.*

4. Replace the valve cap.

5. Repeat this procedure for each tire, including the spare.

Note: *Some spare tires operate at a higher inflation pressure than the other tires. For T type mini-spare tires, (see the Dissimilar spare wheel and tire assembly information for a description. Store and maintain at 4.15 bar (60 psi) 60 psi (4.15 bar). For full-size and dissimilar spare tires, see the Dissimilar spare wheel and tire assembly information for a description. Store and maintain at the higher of the front and rear inflation pressure as shown on the Safety Compliance Certification Label or Tire Label.*

Note: *Do not reduce tire pressure to change the ride characteristics of the vehicle. If you do not maintain the inflation pressure at the levels specified by Ford, your vehicle may experience a condition known as shimmy. Shimmy is a severe vibration and oscillation in the steering wheel after the vehicle travels over a bump or dip in the road that does not dampen out by itself. Shimmy may result from significant under-inflation of the tires, improper tires (load range, size, or type), or vehicle modifications such as lift-kits. In the event that your vehicle experiences shimmy, you should slowly reduce speed by either lifting off the accelerator pedal or lightly applying the brakes. The shimmy will cease as the vehicle speed decreases.*

Tire Care

When weather temperature changes occur, tire inflation pressures also change. A 10°F (6°C) temperature drop can cause a corresponding drop of 1 psi (7 kPa) in inflation pressure. Check your tire pressures frequently and adjust them to the proper pressure which can be found on the Safety Compliance Certification Label or Tire Label.

Checking Pressure when tires are hot:

If pressures are checked after tires have been driven for more than three minutes or more than 1 mile, (2 km) the tires become hot and the pressures will increase by approximately 4 psi (27.6 kPa). Therefore when the tire pressure is adjusted under these conditions, it should be increased to a gauge reading of 4 psi (27.6 kPa) greater than the recommended cold inflation pressure.

After inflating the tires while hot, make sure to recheck tire pressure later once the tires are cold.

For Example Only

Gauge reading of hot tire	33 psi (230 kPa)
If recommended, cold inflation pressure is	32 psi (220 kPa)
The hot tire pressure is only 1 psi (10 kPa) greater than the recommended cold inflation pressure. Therefore, add 3 psi (20 kPa) more to increase the hot pressure to 4 psi (30 kPa) over the recommended cold inflation pressure.	
New hot pressure	36 psi (250 kPa)

Steel Carcass Plies

**WARNING:** An inflated tire and rim can be very dangerous if improperly used, serviced or maintained. To reduce the risk of serious injury, never attempt to re-inflate a tire which has been run flat or seriously under-inflated without first removing the tire from the wheel assembly for inspection. Do not attempt to add air to tires or replace tires or wheels without first taking precautions to protect persons and property.

All tires with Steel Carcass Plies (if equipped):

Tire Care

This type of tire utilizes steel cords in the sidewalls. As such, they cannot be treated like normal light truck tires. Tire service, including adjusting tire pressure, must be performed by personnel trained, supervised and equipped according to Federal Occupational Safety and Health Administration regulations. For example, during

any procedure involving tire inflation, the technician or individual must utilize a remote inflation device, and ensure that all persons are clear of the trajectory area.

 **WARNING:** Always inflate steel carcass tires with a remote air fill with the person inflating standing at a minimum of 3.66 m (12 ft) away from the wheel and tire assembly.

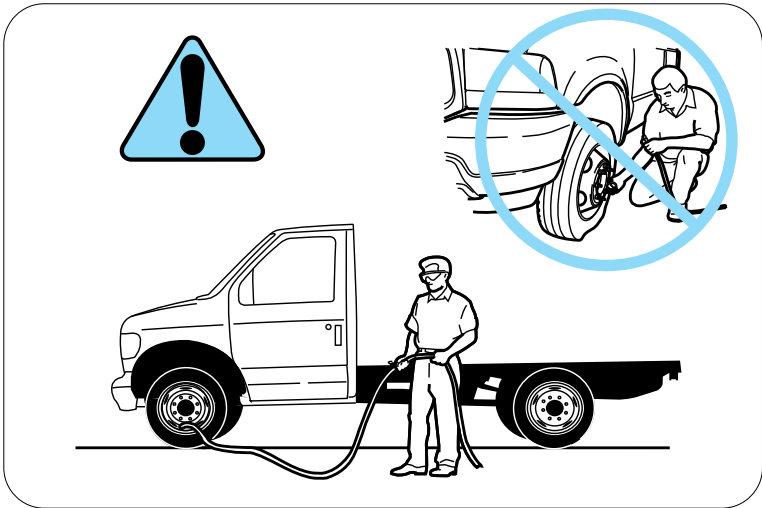

Tire Care

INSPECTING THE TIRE FOR WEAR

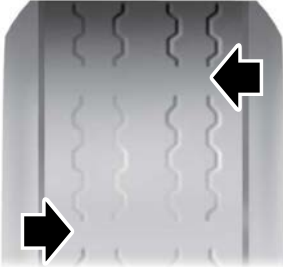

When the tread is worn down to 2/32 inch (1.6 mm), tires must be replaced to help prevent your vehicle from skidding and hydroplaning. Built-in treadwear indicators, or wear bars, which look like narrow strips of smooth rubber across the tread will appear on the tire when the tread is worn down to 2/32 inch (1.6 mm).

When the tire tread wears down to the same height as these wear bars, the tire is worn out and must be replaced.

The tires should also be balanced periodically. An unbalanced tire and wheel assembly may result in irregular tire wear.

Periodically inspect the tire treads for uneven or excessive wear and remove objects such as stones, nails or glass that may be wedged in the tread grooves.

INSPECTING THE TIRE FOR DAMAGE

Inspect the tire sidewalls for cracking, cuts, bruises and other signs of damage or excessive wear. If internal damage to the tire is suspected, have the tire dismantled and inspected in case it needs to be repaired or replaced. For your safety, tires that are damaged or show signs of excessive wear should not be used because they are more likely to blow out or fail.

Periodically inspect the tire treads and sidewalls for damage, such as bulges in the tread or sidewalls, cracks in the tread groove and separation in the tread or sidewall. If damage is observed or suspected, have the tire inspected by a tire professional.

Tires can be damaged during off-road use, so inspection after off-road use is also recommended.

Safety Practices



WARNING: If your vehicle is stuck in snow, mud or sand, do not rapidly spin the tires; spinning the tires can tear the tire and cause an explosion. A tire can explode in as little as three to five seconds.

Tire Care



WARNING: Do not spin the wheels at over 55 km/h (34 mph). The tires may fail and injure a passenger or bystander.

HIGH SPEED DRIVING CAN BE DANGEROUS

Correct inflation pressure is especially important. However, at high speeds, even with the correct inflation pressure, a road hazard for example is more difficult to avoid and if contact is made, has a greater chance of causing tire damage than at a lower speed. Moreover, driving at high speed reduces the reaction time available to avoid accidents and bring your vehicle to a safe stop.

If you see any damage to a tire or wheel, replace it with the spare at once and visit a participating Tire Retailer.

Exceeding the maximum speeds shown on the following page for each type of tire will cause the tire to build up excessive heat which can cause tire damage that could result in sudden tire destruction and rapid air loss. Failure to control a vehicle when one or more tires experience a sudden air loss can lead to an accident.

In any case, you should not exceed reasonable speeds as indicated by the legal limits and driving conditions.

DO NOT OVERLOAD: DRIVING ON ANY OVERLOADED TIRE IS DANGEROUS

The maximum load rating of your tires is molded on the tire sidewall. Do not exceed this rating. Follow the loading instructions of the manufacturer of your vehicle and this will ensure that your tires are not overloaded. Tires which are loaded beyond their maximum allowable loads for the particular application will build up excessive heat that may result in sudden tire destruction. Do not exceed the gross axle weight rating for any axle on your vehicle.

TIRE ALTERATIONS

Do not make or allow to be made any alterations on your tires. Alterations may prevent proper performance, leading to tire damage which can result in an accident. Tires which become unserviceable due to alterations such as truing, whitewall inlays, addition of balancing or sealant liquids, or the use of tire dressing containing petroleum distillates are excluded from warranty coverage.

Tire Care

REPAIRS - WHEREVER POSSIBLE, SEE YOUR TIRE RETAILER AT ONCE

If any tire sustains a puncture, have the tire demounted and thoroughly inspected by a tire retailer for possible damage that may have occurred. A tread area puncture in any passenger or light truck tire can be repaired provided that the puncture hole is not more than 1/4" in diameter, not more than one radial cable per casing ply is damaged, and the tire has not been damaged further by the puncturing object or by running underinflated. Tire punctures consistent with these guidelines should only be repaired by following the US Tire Manufacturers Association (USTMA) recommended repair procedures. Plug-only repairs done on-the-wheel are considered improper and therefore, not recommended. Such repairs are not reliable and may cause further damage to the tire.

STORAGE

Tires contain waxes and emollients to protect their outer surfaces from ozone and weather checking. As the tire rolls and flexes, the waxes and emollients continually migrate to the surface, replenishing this protection throughout the normal use of the tire. Consequently, when tires sit unused for long periods of time (a month or more) their surfaces

become dry and more susceptible to ozone and weather checking and the casing becomes susceptible to flat spotting. **For this reason, tires should always be stored in a cool, dry, clean, indoor environment. If storage is for one month or more, eliminate the weight from the tires by raising the vehicle or by removing the tires from the vehicle. Failure to store tires in accordance with these instructions could result in damage to your tires or premature aging of the tires and sudden tire failure.**

When tires are stored, be sure they are placed away from sources of heat and ozone such as direct sunlight, hot pipes and electric generators. Be sure that surfaces on which tires are stored are clean and free from grease, gasoline or other substances, which could deteriorate the rubber. Failure to store tires in accordance with these instructions could result in damage to your tires or premature aging of the tires and sudden tire failure.

Tire Care

FOLLOW THESE MOUNTING RECOMMENDATIONS

Tire changing can be dangerous and must be done by professionally trained persons using proper tools and procedures as specified by the US Tire Manufacturers Association (USTMA). Single or dual assemblies must be completely deflated before demounting.

Your tires should be mounted on wheels of correct size and type and which are in good, clean condition. Wheels that are bent, chipped, rusted (steel wheels) or corroded (alloy wheels) may cause tire damage. The inside of the tire must be free from foreign material. Have your retailer check the wheels before mounting new tires. Mismatched tires and rims can explode during mounting. Also, mismatched tires and rims can result in dangerous tire failure on the road. If a tire is mounted by error on the wrong-sized rim, do not remount it on the proper rim – scrap it. It may have been damaged internally (which is not externally visible) by having been dangerously stretched and could fail on the highway.

Old valves may leak. When new tubeless tires are mounted, have new valves of the correct type installed. Tubeless tires must only be mounted on wheels designed for tubeless tires i.e., wheels which have safety humps or ledges.

It is recommended that you have your tires and wheels balanced. Tires and wheels, which are not balanced, may cause steering difficulties, a bumpy ride, and irregular tire wear.

Be sure that all your valves have suitable valve caps. The valve cap is the primary seal against air loss.

TEMPORARY SPARE TIRES

When using any temporary spare tire, be sure to follow the vehicle manufacturer's instructions.

REMEMBER... TO AVOID DAMAGE TO YOUR TIRES AND POSSIBLE ACCIDENT:

- CHECK TIRE PRESSURE AT LEAST ONCE EACH MONTH WHEN TIRES ARE COLD AND BEFORE LONG TRIPS.
- DO NOT UNDERINFLATE/OVERINFLATE.
- DO NOT OVERLOAD.
- DRIVE AT MODERATE SPEEDS, OBSERVE LEGAL LIMITS.

Tire Care

- AVOID DRIVING OVER POTHoles, OBSTACLES, CURBS OR EDGES OF PAVEMENT.
- AVOID EXCESSIVE WHEEL SPINNING.
- IF YOU SEE ANY DAMAGE TO A TIRE, REPLACE WITH THE SPARE AND VISIT ANY AUTHORIZED RETAILER AT ONCE.
- IF YOU HAVE ANY QUESTIONS, CONTACT YOUR AUTHORIZED RETAILER.

Highway Hazards

No matter how carefully you drive, there is always the possibility that you could eventually have a flat tire on the highway. Drive slowly to the closest safe area out of traffic. This could further damage the flat tire, but your safety is more important.

If you feel a sudden vibration or ride disturbance while driving, or you suspect your tire or vehicle has been damaged, immediately reduce your speed. Drive with caution until you can safely pull off the road. Stop and inspect the tires for damage. If a tire is under-inflated or damaged, deflate it, remove the wheel and replace it with your spare tire and wheel. If you cannot detect a cause, have the vehicle towed to the nearest repair facility or tire dealer to have the vehicle inspected.

Tire and Wheel Alignment

A bad jolt from hitting a curb or pothole can cause the front end of your vehicle to become misaligned or cause damage to your tires. If your vehicle seems to pull to one side when you are driving, the wheels could be out of alignment. Have an authorized dealer check the wheel alignment periodically.

Wheel misalignment in the front or the rear can cause uneven and rapid treadwear of your tires and should be corrected by an authorized dealer.

INSPECTING THE WHEEL VALVE STEMS

Check the valve stems for holes, cracks, or cuts that may permit air leakage and replace the valve stem if damaged.

Note: *A new valve stem (including new nut, new washer & new screw) must be installed whenever a new tire or wheel is installed.*

TIRE ROTATION



WARNING: If the tire label shows different tire pressures for the front and rear tires and the vehicle has a tire pressure monitoring system, then you need to update the settings for the system sensors. Always

Tire Care

perform the system reset procedure after tire rotation. If you do not reset the system, it may not provide a low tire pressure warning when necessary.

Rotating your tires at the recommended interval will help your tires wear more evenly, providing better tire performance and longer tire life.

Note: If your tires show any uneven wear have the alignment checked by an authorized dealer before rotating tires.

Note: If you have a dissimilar spare wheel and tire assembly, it is intended for temporary use only and should not be used in a tire rotation.

Note: After having your tires rotated, inflation pressure must be checked and adjusted to the vehicle requirements.

Tire Rotation Diagram

Follow the diagram indicating the correct tire locations for rotating the tires.

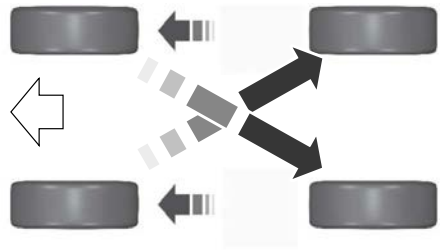

Rear-wheel drive vehicles and four-wheel drive vehicles (front tires at left of diagram).

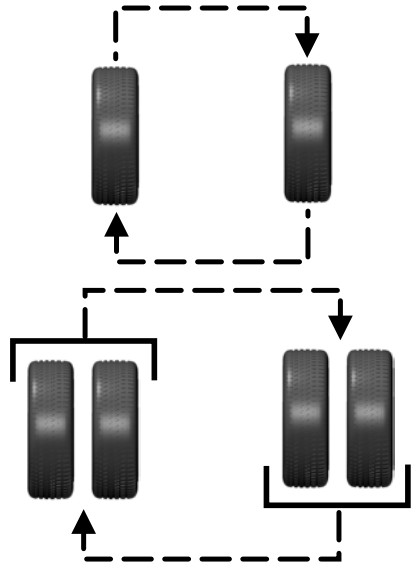

Dual rear wheel drive vehicle - six tire rotation (front tires at top of diagram).

Tire Care

If your vehicle is equipped with dual rear wheels it is recommended that the front and rear tires (in pairs) be rotated only side to side. We do not recommend splitting up the dual rear wheels. Rotate them side to side as a set. After tire rotation, inflation pressures must be adjusted for the tires' new positions in accordance with vehicle requirements.

Note: When installing 17-inch dual rear wheels, align the valve stems facing each other. If your vehicle is equipped with 4 rear aluminum wheels, ensure the inner wheel valve stem is accessible through a vent hole in the outer wheel without the valve stem.

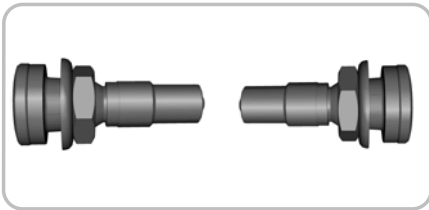
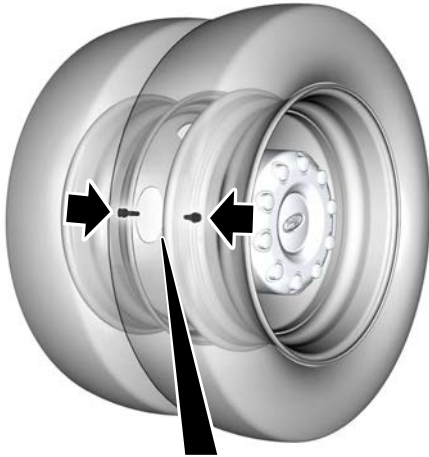

Tire Pressure Monitoring System (If Equipped)

WHAT IS THE TIRE PRESSURE MONITORING SYSTEM



The tire pressure monitoring system measures the vehicle's tire pressures. A warning lamp illuminates if one or more tires are significantly underinflated or if there is a system malfunction.

TIRE PRESSURE MONITORING SYSTEM OVERVIEW



WARNING: Under-inflation is the most common cause of tire failures and may result in severe tire cracking, tread separation or blowout, with unexpected loss of vehicle control and increased risk of injury. Under-inflation increases sidewall flexing and rolling resistance, resulting in heat buildup and internal damage to the tire. It also may result in unnecessary tire stress, irregular wear, loss of vehicle control and accidents. A tire can lose up to half of its air pressure and not appear to be flat!



WARNING: To determine the required pressure(s) for your vehicle, see the Safety Compliance Certification Label (on the door hinge pillar, door-latch post or the door edge that meets the door-latch post, next to the driver seat) or the Tire Label on the B-Pillar or the edge of the driver door.

Each tire, including the spare (if provided), should be checked monthly when cold and inflated to the inflation pressure recommended by the vehicle manufacturer on the vehicle placard or tire inflation pressure label. (If your vehicle has tires of a different size than the size indicated on the vehicle placard or tire inflation pressure label, you should determine the proper tire inflation pressure for those tires).

As an added safety feature, your vehicle has been equipped with a Tire Pressure Monitoring System (TPMS) that illuminates a low tire pressure telltale when one or more of your tires is significantly under-inflated. Accordingly, when the low tire pressure telltale illuminates, you should stop and check your tires as soon as possible, and inflate them to the proper pressure. Driving on a significantly under-inflated tire causes the tire to overheat and can lead to tire failure. Under-inflation also reduces fuel efficiency and tire tread life, and may affect the vehicle's handling and stopping ability.

Please note that the TPMS is not a substitute for proper tire maintenance, and it is the driver's responsibility to maintain correct tire pressure, even if under-inflation has not reached the level to trigger illumination of the TPMS low tire pressure telltale.

Your vehicle has also been equipped with a TPMS malfunction indicator to indicate when the system is not operating properly. The TPMS malfunction indicator is combined with the low tire pressure telltale. When the system detects a malfunction, the telltale will flash for approximately one minute and then remain continuously illuminated. This sequence will continue upon subsequent vehicle start-ups as long as the malfunction exists.

Tire Pressure Monitoring System (If Equipped)

When the malfunction indicator is illuminated, the system may not be able to detect or signal low tire pressure as intended. TPMS malfunctions may occur for a variety of reasons, including the installation of replacement or alternate tires or wheels on the vehicle that prevent the TPMS from functioning properly. Always check the TPMS malfunction telltale after replacing one or more tires or wheels on your vehicle to ensure that the replacement or alternate tires and wheels allow the TPMS to continue to function properly.



WARNING: Changes or modifications not expressly approved by the party responsible for compliance could void the user's authority to operate the equipment. The term "IC:" before the radio certification number only signifies that Industry Canada technical specifications were met.

This device complies with Part 15 of the FCC Rules and with License exempt RSS Standards of Industry Canada. Operation is subject to the following two conditions:

1. This device may not cause harmful interference, and
2. This device must accept any interference received, including interference that may cause undesired operation.

TIRE PRESSURE MONITORING SYSTEM PRECAUTIONS



WARNING: The tire pressure monitoring system is not a substitute for manually checking tire pressures. You should periodically check tire pressures using a pressure gauge. Failure to correctly maintain tire pressures could increase the risk of tire failure, loss of control, vehicle rollover and personal injury.



WARNING: Do not use the tire pressure displayed in the information display as a tire pressure gauge. Failure to follow this instruction could result in personal injury or death.

Note: *The use of tire sealants can damage the tire pressure monitoring system.*

Note: *If the tire pressure monitor sensor becomes damaged it may not function.*

TIRE PRESSURE MONITORING SYSTEM LIMITATIONS

When the outside temperature drops significantly, the tire pressure could decrease and activate the low tire pressure warning lamp.

The warning lamp could also illuminate when you use a spare wheel, or tire sealant from the inflator kit.

Note: *Regularly checking the vehicle tire pressures can reduce the possibility for the warning lamp to illuminate due to outside air temperature changes.*

Note: *After you inflate the tires to the recommended pressure it could take up to two minutes of driving over 32 km/h (20 mph) for the warning indicator to turn off.*

Tire Pressure Monitoring System (If Equipped)

VIEWING THE TIRE PRESSURES



Using the instrument cluster display arrow keys navigate to the truck info section where you can view the tire pressures.

RESETTING TIRE PRESSURE MONITORING SYSTEM

Tire Pressure Monitoring System Reset Procedure - Single Rear Wheel



WARNING: To determine the required pressure(s) for your vehicle, see the Safety Compliance Certification Label (on the door hinge pillar, door-latch post or the door edge that meets the door-latch post, next to the driver seat) or the Tire Label on the B-Pillar or the edge of the driver door.

You must reset the tire pressure monitoring system after each tire rotation on vehicles that require different recommended tire pressures in the front tires as compared to the rear tires.

Note: To reduce the chances of interference from another vehicle, perform the system reset procedure at least 3 ft (1 m) away from another vehicle undergoing the system reset procedure at the same time.

Note: Do not wait more than two minutes between resetting each tire sensor or the system can time-out and you need to repeat the entire procedure on all four wheels.

1. Drive the vehicle above 32 km/h (20 mph) for at least two minutes, then park in a safe location where you can easily get to all four tires and have access to an air pump.
2. Switch the ignition off.
3. Switch the ignition on but do not start the engine.
4. Switch the hazard flashers on then off three times.

Note: You must accomplish this within 10 seconds. If you successfully enter the reset mode, the horn sounds once, the system indicator flashes and a message shows in the instrument cluster display.

Tire Pressure Monitoring System (If Equipped)

Note: *If the system does not enter reset mode, repeat the procedure starting at step 2. If after repeated attempts to enter the reset mode, the horn does not sound, the system indicator does not flash and no message shows in the instrument cluster display, contact your authorized dealer.*

5. Remove the valve cap from the valve stem on the left front tire. Decrease the air pressure until the horn sounds.

Note: *The single horn tone confirms that the sensor identification code has been learned by the module for this position. If the horn sounds twice, the reset procedure was unsuccessful, and you must repeat it.*

6. Remove the valve cap from the valve stem on the right front tire. Decrease the air pressure until the horn sounds.
7. Repeat the previous step on the right rear tire and then on the left rear tire.
8. Switch the ignition off.

Note: *If the horn sounds twice again after switching the ignition off, and repeating the procedure, contact your authorized dealer and have your vehicle checked as soon as possible.*

9. Set all four tires to the recommended air pressure as indicated on the Safety Compliance Certification Label.

Tire Pressure Monitoring System Reset Procedure - Dual Rear Wheel

For further information see **Understanding Your Tire Pressure Monitoring System** and refer to **Dual Rear Wheel**, earlier in this section.

Read the entire procedure before attempting.

1. Drive the vehicle above 32 km/h (20 mph) for at least two minutes, then park in a safe location where you can easily get to all six tires and have access to an air pump.
2. Place the ignition in the off position and keep the key in the ignition.
3. Cycle the ignition to the on position with the engine off.
4. Turn the hazard flashers on then off three times. You must accomplish this within 10 seconds. If you successfully enter the reset mode, the horn sounds once, the system indicator flashes and a message shows in the instrument cluster display. If this does not occur, repeat the procedure starting at step 2. If after repeated attempts to enter the reset mode, the horn

Tire Pressure Monitoring System (If Equipped)

does not sound, the system indicator does not flash and no message shows in the instrument cluster display, contact your authorized dealer as soon as possible.

5. Train the tire pressure monitoring system sensors in the tires using the following system reset sequence starting with the left front tire in the following order: Left front - driver side front tire, Right front - passenger side front tire, Right outer rear -passenger side rear outer tire, Right inner rear - passenger side rear inner tire, Left outer rear - driver side rear outer tire, Left inner rear - driver side rear inner tire.
6. Remove the valve cap from the valve stem on the left front tire. Decrease the air pressure until the horn sounds.
Note: *The single horn chirp confirms that the sensor identification code has been learned by the module for this position. If a double horn is heard, the reset procedure was unsuccessful, and you must repeat it.*
7. Remove the valve cap from the valve stem on the right front tire. Decrease the air pressure until the horn sounds.
8. Remove the valve cap from the valve stem on the right outer rear tire. Decrease the air pressure until the horn sounds.
9. Remove the valve cap from the valve stem on the right inner rear tire. Decrease the air pressure until the horn sounds.
10. Remove the valve cap from the valve stem on the left outer rear tire. Decrease the air pressure until the horn sounds.
11. Remove the valve cap from the valve stem on the left inner rear tire. Decrease the air pressure until the horn sounds. Training is complete after the horn sounds for the last tire trained, the system indicator stops flashing, and a message is shown in the instrument cluster display.
12. Turn the ignition off. If two short horn beeps are heard, the reset procedure was unsuccessful and you must repeat it. If after repeating the procedure and two short beeps are heard when the ignition is turned to off, contact your authorized dealer as soon as possible.
13. Set all six tires to the recommended air pressure as indicated on the Safety Compliance Certification Label, affixed to either the door hinge pillar, door-latch post, or the door edge that meets the door-latch post, next to the driver seating position or tire label located on the B-pillar or the edge of the driver door.

Tire Pressure Monitoring System (If Equipped)

Trailer Tire Pressure Monitoring System (If Equipped)

Note: Additional equipment may be required for your vehicle to support trailer tire pressure and temperature monitoring. See your authorized dealer for more information.

Note: The trailer tire pressure monitoring system is not a substitute for proper tire maintenance. It is your responsibility to maintain correct tire pressures at all times.

Note: Replace the screw and valve on the trailer tire pressure sensor anytime the trailer tire is repaired, replaced or in for service. See your authorized dealer for details.



The trailer tire pressure monitoring system is an added safety feature that allows you to view your trailer tire pressures and temperatures through the instrument cluster display. See **Tire Pressure Monitoring System – Information Messages** (page

529). Tire pressure sensors are mounted into each tire on your trailer. The sensors send a message to your vehicle indicating the current trailer tire pressure and temperature.

If the trailer tire pressure monitoring system detects that a tire is low, a warning message appears in the instrument cluster display. The trailer tire information screen in the instrument cluster display highlights the tire with a low pressure.

If the trailer tire pressure monitoring system detects that a tire temperature is over temp, a warning message appears in the instrument cluster display. The trailer tire information screen in the instrument cluster display highlights the tire with a high temperature.

The main function of the trailer tire pressure monitoring system is to warn you when your trailer tires need air or if the tires are experiencing high temperatures. It can also warn you if the system is no longer capable of functioning as intended. See **Tire Pressure Monitoring System – Information Messages** (page 529).

Tire Pressure Monitoring System (If Equipped)

When a Temporary Spare or New Tire is Installed

If you have replaced a trailer tire with a new or spare tire, a warning message appears and pressure readings are no longer displayed for that tire.

To restore the full function of the trailer tire pressure monitoring system:

- Have the damaged wheel and tire assembly repaired and remounted to your trailer.
- Install the trailer tire pressure monitoring sensor into the new wheel and tire assembly.
- Perform the trailer tire pressure monitoring system reset procedure.

Trailer Tire Pressure Monitoring System Reset Procedure

Note: *You need to perform the tire pressure monitoring system reset procedure after each tire rotation, or when a new trailer tire pressure sensor is installed into a trailer tire.*

The trailer tire pressure monitoring system can be reset through the menu in the instrument cluster display. See **Tire Pressure Monitoring System – Information Messages** (page 529). Performing the trailer setup process also resets the trailer tire pressure monitoring system.

Note: *For further information on the trailer tire pressure monitoring system see the instructions that were included with the trailer tire pressure monitoring system kit.*

TIRE PRESSURE MONITORING SYSTEM – TROUBLESHOOTING

TIRE PRESSURE MONITORING SYSTEM – WARNING LAMPS



The low tire pressure warning lamp has combined functions, as it warns you when your tires need air, and when the system is no longer capable of functioning as intended.

Tire Pressure Monitoring System (If Equipped)

Warning Lamp	Possible Cause	Action Required
Solid warning lamp	One or more tires are significantly under inflated	After inflating your tires to the manufacturer's recommended pressure as shown on the tire label, on the edge of driver door or the B-pillar, drive your vehicle for at least two minutes over 32 km/h (20 mph) before the light turns off.
	Tire rotation without sensor training	On vehicles with different front and rear tire pressures, the system must be retrained following every tire rotation.
Solid warning lamp or flashing warning lamp	Temporary spare wheel in use	Repair the damaged road wheel and tire and refit it to your vehicle to restore operation of the system.
	Tire pressure monitoring system malfunction	If the tires are inflated to the recommended tire pressures and the temporary spare wheel is not in use, the system detected a fault that requires service. Have your vehicle checked as soon as possible.

Tire Pressure Monitoring System (If Equipped)

TIRE PRESSURE MONITORING SYSTEM – INFORMATION MESSAGES

Message	Action
Tire Pressure Low	After inflating your tires to the manufacturer's recommended pressure as shown on the Tire Label, on the edge of the driver door or the B-Pillar, drive your vehicle for at least two minutes over 32 km/h (20 mph) before the light turns off.
Tire Pressure Monitor Fault	The system has detected a fault that requires service. Have your vehicle checked as soon as possible.
Tire Pressure Sensor Fault	The system has detected a fault that requires service or a spare tire is in use. Have your vehicle checked as soon as possible.

Trailer Tire Pressure Monitoring System

Message	Action
Trailer Tire Low Specified:	One or more tires on your trailer is below the specified tire pressure.
Trailer Tire Over Temperature	Displays when one or more tires on your trailer is above the recommended temperature.
Trailer Tire Pressure Sensor Fault	A trailer tire pressure sensor is malfunctioning. If the warning stays on or continues to come on, contact an authorized dealer as soon as possible.
Trailer Tire Pressure Monitor Fault	The trailer tire pressure monitoring system is malfunctioning. If the warning stays on or continues to come on, contact an authorized dealer.
Trailer Tire Pressure Monitor Capability Not Detected	The system cannot detect the trailer tire pressure monitoring system.
Trailer Tire Pressure Indication Not Setup See Manual	The trailer tire pressure monitoring system is not setup. See Tire Pressure Monitoring System (page 521).

Changing a Road Wheel

CHANGING A FLAT TIRE

If you get a flat tire when driving, do not apply the brake heavily. Instead, gradually decrease your speed, hold the steering wheel firmly and slowly move to a safe place on the side of the road.

Have a flat serviced by an authorized dealer to prevent damage to the system sensors. See **Tire Pressure Monitoring System Precautions** (page 522). Replace the spare tire with a road tire as soon as possible. During repairing or replacing the flat tire, have the authorized dealer inspect the system sensor for damage.

Note: Only use tire sealants in roadside emergencies as they may damage the tire pressure monitoring system sensor.

Note: The tire pressure monitoring system indicator light illuminates when the spare tire is in use. To restore the full functionality of the monitoring system, all road wheels equipped with tire pressure monitoring sensors must be mounted on this vehicle.

Dissimilar Spare Wheel and Tire Assembly Information



WARNING: Failure to follow these guidelines could result in an increased risk of loss of vehicle control, injury or death.

If you have a dissimilar spare wheel and tire, then it is intended for temporary use only. This means that if you need to use it, you should replace it as soon as possible with a road wheel and tire assembly that is the same size and type as the road tires and wheels that were originally provided by Ford. If the dissimilar spare tire or wheel is damaged, it should be replaced rather than repaired.

A dissimilar spare wheel and tire assembly is defined as a spare wheel and tire assembly that is different in brand, size or appearance from the road tires and wheels.

Full-size dissimilar spare

When driving with the full-size dissimilar spare wheel and tire assembly, do not:

- Exceed 113 km/h (70 mph).
- Use more than one dissimilar spare wheel and tire assembly at a time.
- Use snow chains on the end of the vehicle with the dissimilar spare wheel and tire assembly.
- Engage any four-wheel drive mode. See **Four-Wheel Drive Limitations** (page 233).

When driving with the full-size dissimilar spare wheel and tire assembly, 4WD functionality may be limited. You may experience the following:

- Additional noise from the transfer case or other drive components.
- Difficulty shifting out of a mechanically locked 4WD mode.

When driving with the full-size dissimilar spare wheel and tire assembly, it is recommended that you do not:

- Engage 4WD High or 4WD Low, if equipped, other than to get your vehicle unstuck.

Using a full-size dissimilar spare wheel and tire assembly can compromise the effectiveness of the following:

- Handling, stability and braking performance.
- Comfort and noise.
- Ground clearance and parking at curbs.
- Winter weather driving capability.
- Wet weather driving capability.
- Four-wheel drive capability.

Changing a Road Wheel

When driving with the full-size dissimilar spare wheel and tire assembly additional caution should be given to:

- Towing a trailer.
- Driving vehicles equipped with a camper body.
- Driving vehicles with a load on the cargo rack.

Drive cautiously when using a full-size dissimilar spare wheel and tire assembly and seek service as soon as possible.

Location of the Spare Tire and Tools

See the following table for their locations:

Item	Location
Spare tire - pick-up trucks only	Under the vehicle, just forward of the rear bumper.
Jack	Fastened to the floor pan behind the rear-most seat on the passenger side.
Jack handle, lug wrench, lug wrench extension - only provided on dual rear wheel vehicles.	Regular Cab: Fastened to floor behind the driver seat. Super Cab and Crew Cab: Fastened to the floor under the rear seat on the driver's side.

Tire Change Procedure



WARNING: The jack supplied with this vehicle is only intended for changing a flat tire in an emergency. Do not attempt to do any other work on your vehicle when it is supported by the jack, as your vehicle could slip off the jack. Failure to follow this instruction could result in personal injury or death.

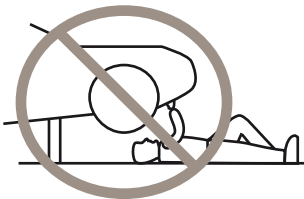

WARNING: To help prevent your vehicle from moving when changing a wheel, shift the transmission into park (P), set the parking brake and use an appropriate block or wheel chock to secure the wheel diagonally opposite to the wheel being changed. For example, when changing the front left wheel, place an appropriate block or wheel chock on the right rear wheel.



WARNING: Only use the jack provided as original equipment with your vehicle.



WARNING: Failure to follow these guidelines could result in an increased risk of loss of vehicle control, injury or death.



WARNING: Never place anything between the vehicle jack and your vehicle.

Changing a Road Wheel

WARNING: Never place anything between the vehicle jack and the ground.

WARNING: Do not attempt to change a tire on the side of the vehicle close to moving traffic. Pull far enough off the road to not obstruct the flow of traffic and avoid the danger of being hit when operating the jack or changing the wheel.

WARNING: The jack supplied with this vehicle is only intended for changing a flat tire in an emergency. Do not attempt to do any other work on your vehicle when it is supported by the jack, as your vehicle could slip off the jack. Failure to follow this instruction could result in personal injury or death.

WARNING: Only use the spare wheel carrier to stow wheels provided with your vehicle.

Note: Do not use impact tools or power tools operating at over 200 RPM on the spare wheel carrier winch, which may cause it to malfunction and result in the wheel and tire not being securely stowed.

Note: Passengers should not remain in the vehicle when the vehicle is being jacked.

1. Park the vehicle on a level firm ground and activate the hazard flashers.
2. Apply the parking brake, place the transmission in park (P), switch the engine off.
3. Block the wheel diagonally opposite the flat tire. If equipped, use the wheel chocks attached to the tool bag. For example, if the left front tire is flat, block the right rear wheel.

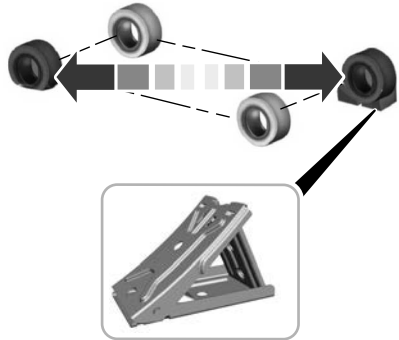

4. The jack is on the floor behind the rearmost seat on the passenger side. Turn the retainers counterclockwise to remove the jack.

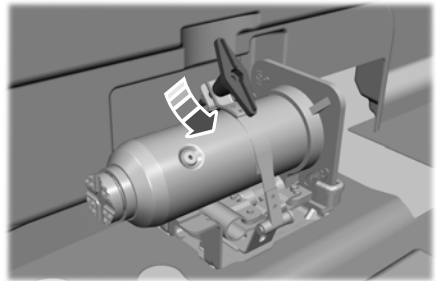

5. The tool kit is on the floor under the driver seat or under the rear seat on the driver side. The tool kit could be attached to the floor, inside the storage bin, or attached to a bracket. Turn the retainers counterclockwise to remove the tool kit.

Changing a Road Wheel

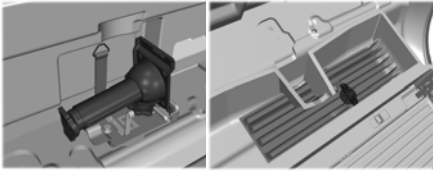

6. Use the ignition key to open the lock at the rear bumper.
7. One or more handle extensions are used to operate the spare tire carrier. To assemble, align the button with the hole and slide the parts together. To disconnect, press the button and pull apart.

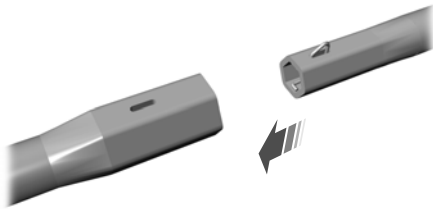

8. The lug wrench turns the handle extensions and the jack handle. Slide the square end of the handle extension into the square hold of the lug wrench until it clicks in place.

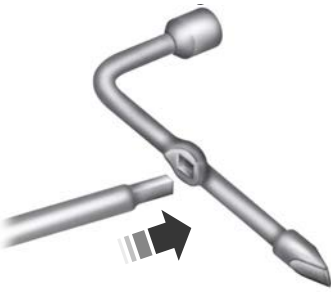

9. Fully insert the jack handle, with one extension, through the bumper hole and into the guide tube. Additional extensions are needed if the tailgate is in the lowered position and cannot be raised. Turn the handle counterclockwise and lower the spare tire until you can slide the tire rearward and the cable is slack. You will feel some resistance when you turn the jack handle assembly. If not replacing the spare or flat tire to the underbody storage area, raise the wheel retainer up into the installed position. Do not store spare or flat tire at other locations.
10. Slide the retainer through the center of the spare tire wheel and remove the spare tire.

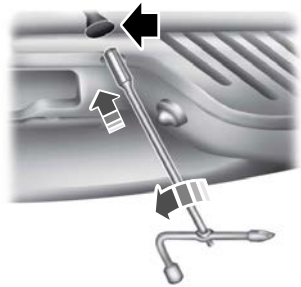

11. Remove the wheel trim with the lug wrench tip, or use the wheel trim tool described later in this section.
12. Loosen each wheel nut one-half turn counterclockwise, but do not remove them until the wheel is raised off the ground. For dual rear wheel, assemble the lug wrench and extension tool together to access the wheel nuts.

Changing a Road Wheel

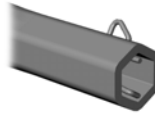

13. Position the jack under the correct jacking points.

Removing Wheel Trim With Single Wheels

1. Insert the flat end of the lug wrench between the wheel rim and the wheel trim.
2. Carefully remove the wheel trim.

The wheel trim removal tool is in the storage bag near the lug wrench.

Vehicles With Dual Rear Alloy Wheels

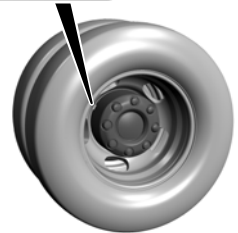
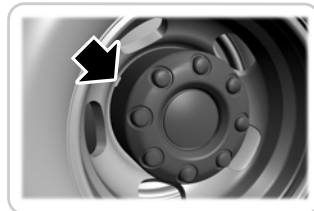
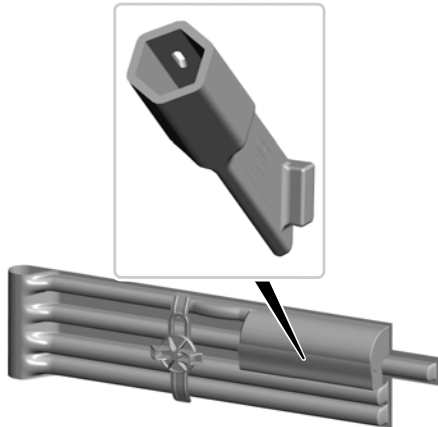

1. Locate the notch in the wheel trim.

Changing a Road Wheel

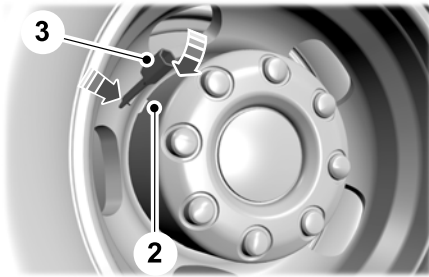

2. Insert the wheel trim removal tool into the notch in the wheel trim.
3. Rotate the wheel trim removal tool and remove the wheel trim.

Jacking the Vehicle

F-250 and F-350 Single Rear Wheel Vehicles

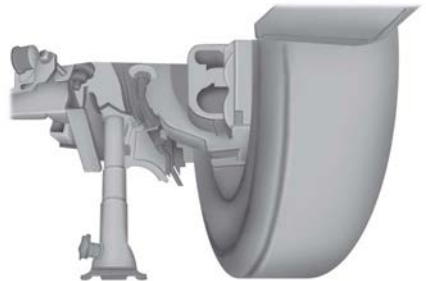
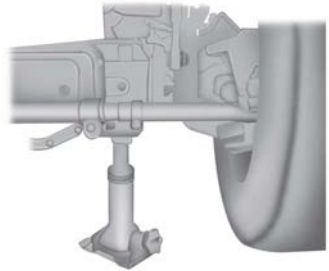

Changing a Road Wheel

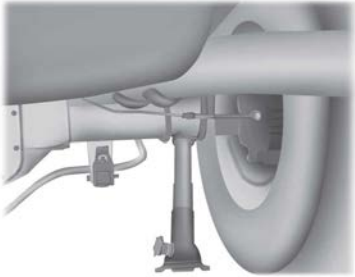

F-350 Dual Rear Wheel, F-450, F-550 and F-600 Vehicles



Front passenger side (4x4): F-350 dual rear wheel

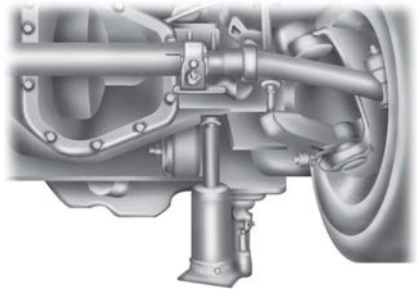

Front driver side (4x4): F-350 dual rear wheel

Note: Make sure the jack fits onto the flat area on the outboard side of the differential housing.



Front (4x2): F-350 Dual rear wheel

Note: Place the jack directly under the I-beam.

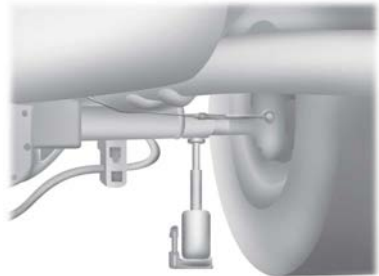

Changing a Road Wheel

Rear: F-350 dual rear wheel



F-350 Dual Rear Wheel Vehicles

Front: F-450 , F-550 and F-600

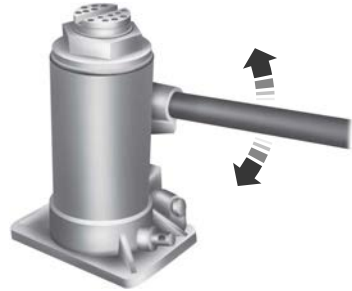
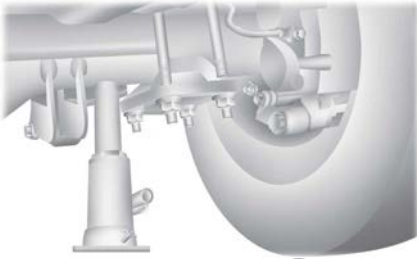

Rear: F-450 , F-550 and F-600

Insert the hooked end of the jack handle into the jack and turn the jack handle clockwise. For hydraulic jacks, operate the handle up and down until the wheel is completely off the ground and high enough to install the spare tire.

Note: Hydraulic jacks have a pressure relief valve that prevents lifting loads which exceed the jack's rated capacity.

F-250 and F-350 Single Rear Wheel Vehicles

Remove the wheel nuts with the lug wrench, replace the flat tire with the spare, making sure the valve stem of the spare is facing outward when replacing a front wheel. For the rear wheel position on vehicles with single rear wheel fitments, install the spare with the valve stem facing outward. For vehicles with dual rear wheels, the valve stem of the spare must face outward when replacing an inner wheel, but must face inward when replacing an outboard wheel.

Reinstall the wheel nuts until the wheel is snug against the hub. Do not fully tighten the wheel nuts until the wheel has been lowered.

Lower the vehicle completely by turning the jack handle counterclockwise until the vehicle is completely lowered.

Changing a Road Wheel

Note: For F-350 Dual Rear Wheel, F-450, F-550 and F-600 Vehicles, insert the notched end of the jack handle to the release valve, open the release valve slightly by turning the handle counterclockwise. Stop turning the release valve when vehicle starts to lower. Close the valve when you completely lower your vehicle.

F-350 Dual Rear Wheel, F-450, F-550 and F-600 Vehicles.



Installing the Wheel Nuts and Ornaments



8-wheel nut torque sequence



10-wheel nut torque sequence

Note: When installing the wheel center ornaments, align the ornament retention towers on the back side of the ornament with the studs or nuts and retain to the flange on the wheel nuts.

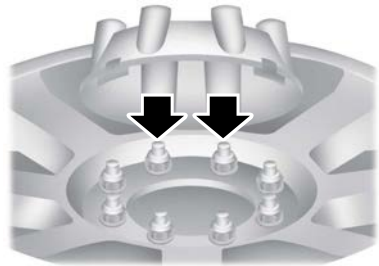

Note: For dual rear wheels, align the ornament with the wheel nuts. (A) is the clip in the ornament and (B) is the flange of the wheel nut. Make sure that each of the retention clips are sitting on a wheel nut flange.

Changing a Road Wheel

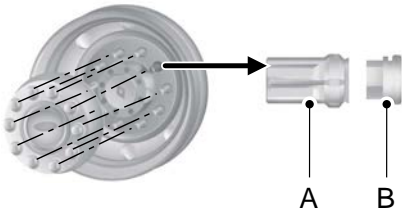

Note: If the ornament retention clips are misaligned between the studs or wheel nuts, the ornament will be improperly installed. This improper installation may appear and sound correct, but will not keep the ornament on the vehicle. Ornaments improperly installed in this manner may become loose or fall off during driving.

Stowing the Flat Tire or Spare Tire

1. Place the tire on end with the valve stem facing toward the front of the vehicle. Lay the tire on the ground, near the rear of the vehicle, with the valve stem side facing up.

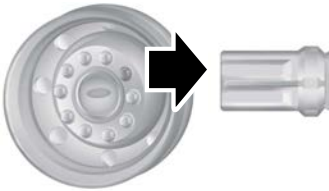

Use your hand or a rubber mallet to tap the ornament until the retention clips snap over the wheel nut flanges. Tap in a star pattern until the ornament seats fully onto the wheel. There should be an even gap between the ornament and the wheel when it is properly installed.

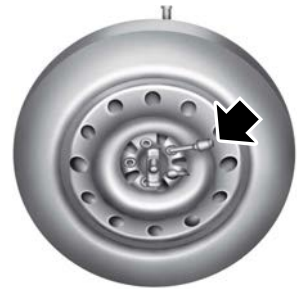

2. Slide the wheel partially under the vehicle and install the retainer through the wheel center. If equipped, you may have to remove the wheel center cap prior to pushing the retainer through the center of the wheel. To remove the center cap, press it off with the lug wrench tip from the inner side of the wheel. Pull on the cable to align the components at the end of the cable.

Changing a Road Wheel

3. Reinsert the lug wrench extension(s) through the rear bumper and guide tube and turn the lug wrench clockwise until the tire is raised to its stowed position underneath the vehicle. The wrench becomes harder to turn and the spare tire winch ratchets or slips when the tire is raised to maximum tightness. You will hear a clicking sound from the winch indicating that the tire is properly stowed, tighten until a minimum of three clicks are heard. Check that the tire lies flat against the frame and is secure.
4. Carefully place all tools back in the tool kit bag.
5. Reinstall the tool kit bag and tighten the wing nut.

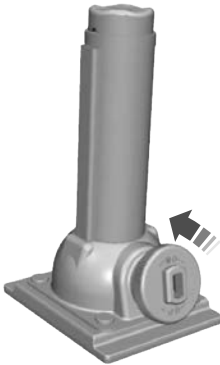

6. Properly reinstall the jack into the bracket and tighten the wing nut.

Note: For the mechanical style bottle jack tighten the jack counterclockwise as shown in the image above.

WHEEL NUTS



WARNING: When you install a wheel, always remove any corrosion, dirt or foreign materials present on the mounting surfaces of the wheel or the surface of the wheel hub, brake drum or brake disc that contacts the wheel. Make sure to secure any fasteners that attach the rotor to the hub so they do not interfere with the mounting surfaces of the wheel. Installing wheels without correct metal-to-metal contact at the wheel mounting surfaces can cause the wheel nuts to loosen and the wheel to come off while your vehicle is in motion, resulting in loss of vehicle control, personal injury or death.

Bolt Size	Nm (lb.ft) ¹
M14 x 1.5	204 Nm (150 lb.ft)

¹ Torque specifications are for nut and bolt threads free of dirt and rust. Use only our recommended replacement wheel nuts and or wheel bolts.

Retighten the wheel nuts to the specified torque within 160 km (100 mi) after any wheel disturbance, such as tire rotation, changing a flat tire or wheel removal.

On vehicles equipped with dual rear wheels, retighten the wheel lug nuts to the specified torque at 160 km (100 mi), and again at 800 km (500 mi) of new vehicle operation and after any wheel disturbance, such as tire rotation, changing a flat tire, or wheel removal.

It is important to follow the proper wheel mounting and lug nut torque procedures.

Changing a Road Wheel



A Hub pilot bore.

Inspect the wheel pilot hole and mounting surface prior to installation. Remove any visible corrosion or loose particles.

Connected Vehicle

WHAT IS A CONNECTED VEHICLE

A connected vehicle has technology that allows your vehicle to connect to a mobile network and for you to access a range of features. When used in conjunction with the Ford mobile app, it could allow you to monitor and control your vehicle further, for example checking the tire pressures, the fuel level and the vehicle location. For additional information, refer to the local Ford website.

CONNECTED VEHICLE REQUIREMENTS

Connected service and related feature functionality requires a compatible vehicle network.

Some remote features require additional service activation. Log in to your Ford account for details. Some restrictions, third party terms and message or data rates may apply.

CONNECTED VEHICLE LIMITATIONS

Evolving technology, cellular networks, or regulations could affect functionality and availability, or continued provision of some features. These changes could even stop some features from functioning.

CONNECTING THE VEHICLE TO A MOBILE NETWORK

WHAT IS THE MODEM



The modem allows access to a range of features built into your vehicle.

ENABLING AND DISABLING THE MODEM

1. From the settings menu, press Connectivity.
2. Press Connected Vehicle Features.
3. Switch vehicle connectivity on or off.

CONNECTING FORDPASS TO THE MODEM

1. Make sure that the modem is enabled using the vehicle settings menu.
2. Open the FordPass app on your device and log in.
3. Add your vehicle or select your vehicle if already added.
4. Select the option to activate your vehicle.
5. Make sure that the name on the screen matches the name shown in your FordPass account.
6. Confirm that FordPass account is connected to the modem.

CONNECTING THE VEHICLE TO A WI-FI NETWORK

1. From the settings menu, press Connectivity.
2. Press Wi-Fi.
3. Switch Wi-Fi on.
4. Press View Available Networks.
5. Select an available Wi-Fi network.

Note: Enter the network password to connect to a secure network.

Connected Vehicle

CONNECTED VEHICLE SETTINGS

You can adjust several settings on the touchscreen under the connected vehicle features menu, such as:

- Vehicle connectivity.
- Share vehicle data.
- Share vehicle location.
- Share driving data.

Note: Depending on your vehicle, different options may be available.

Note: Editing connectivity settings could result in some features not operating correctly or at all. When you edit connectivity settings, pop-up messages may appear to notify you that services will not work without that setting. If you switch a feature on, pop-up messages could appear informing you of the settings that will be turned on. Some features, for example driver assistance features, use map data. We recommend having all connected vehicle settings enabled to allow the map content to be updated to the latest version.



Press the button next to a menu option for more information.

CONNECTED VEHICLE – TROUBLESHOOTING

CONNECTED VEHICLE – FREQUENTLY ASKED QUESTIONS

Why is my Ford mobile app not connecting to my vehicle?

- The modem is not enabled. Switch vehicle connectivity on.
- The network signal is weak. Move your vehicle closer to a place where the network signal is not obstructed.

Why can I not connect to a Wi-Fi network?

- You entered the wrong network password. Enter the correct password.
- The network signal is weak. Move your vehicle closer to the Wi-Fi router or to a place where the network signal is not obstructed.
- There are multiple access points in range with the same network name. Choose a unique name for your network. Do not use the default name unless it contains a unique identifier, for example as part of the MAC address.

Why does the Wi-Fi connection disconnect after successful connection?

- The network signal is weak. Move your vehicle closer to the Wi-Fi router or to a place where the network signal is not obstructed.

What can I do if I am close to a Wi-Fi router but the network signal strength is weak?

- If your vehicle has a heated windshield, position your vehicle so that the windshield is not facing the Wi-Fi router.
- If your vehicle has metallic tinting on the windows but not on the windshield, position your vehicle so that the windshield is facing the Wi-Fi router or open the windows that are facing the router.
- If your vehicle has metallic tinting on the windows and the windshield, open the windows that are facing the router.
- If your vehicle is in a garage and you have the garage door closed, open the garage door as it could block the signal.

Connected Vehicle

Why can I not see a network I expect to see in the list of available networks?

- The network is hidden. Make the network visible and try again, or manually add a network in the Wi-Fi settings menu.
- Some network security types are not supported, for example WEP.

Why do software downloads take too long?

- The network signal is weak. Move your vehicle closer to the Wi-Fi router or to a place where the network signal is not obstructed.
- Wi-Fi network is in high demand or has a slow Internet connection. Use a more reliable Wi-Fi network.

Why does the software not update when the system seems to connect to a Wi-Fi network and the signal strength is excellent?

- No software update is available at this time.
- Select automatic updates option in the settings menu to enable automatic software update or contact an authorized dealer.
- There could be a connection problem. Test the network using another device.

Vehicle Hotspot

SETTING UP A VEHICLE HOTSPOT

With a data plan, your hotspot can provide devices in and around your vehicle with Wi-Fi data.

Note: *A mobile device is required to complete hotspot setup.*

1. From the settings menu, press Vehicle Hotspot.
2. Press Settings.
3. Press Show Password.
4. Connect your device to the vehicle hotspot by selecting the hotspot from the list of Wi-Fi Networks.
5. When prompted, enter the password.

Activating a Trial or Purchasing a Data Plan

1. Connect a device to your vehicle hotspot. The vehicle network carrier's service activation website opens on your device.

Note: *If the website does not open, open a new website and it redirects to the vehicle network carrier's website.*

2. Follow the instructions on the carrier portal to purchase a plan or start a trial.

Note: *Visit the vehicle network carrier's website to purchase more data.*

Note: *Hotspot services are subject to your vehicle network carrier agreement, coverage and availability.*

VEHICLE HOTSPOT SETTINGS

You can change the following in the vehicle hotspot settings menu:

- Vehicle hotspot name or password.
- Vehicle hotspot frequency.

Changing the Vehicle Hotspot Name or Password

The hotspot information can only be updated once you activate the hotspot.

1. From the settings menu, press Vehicle Hotspot.
2. Press Settings.
3. Press Edit.
4. Press Change Network Name.
5. Enter your required network name.
6. Press enter to save the network name.
7. Press Change Password.
8. Enter your required password.
9. Press enter to save the password.

Changing the Vehicle Hotspot Frequency

The vehicle hotspot frequency band is selectable depending upon your device capabilities. You cannot connect your device to the vehicle hotspot if it does not support the selected frequency band.

1. From the settings menu, press Vehicle Hotspot.
2. Press Settings.
3. Press Edit.
4. Press Change Frequency Band.
5. Select a frequency.

Vehicle Hotspot

VEHICLE HOTSPOT – TROUBLESHOOTING

VEHICLE HOTSPOT – FREQUENTLY ASKED QUESTIONS

Why can I not see the vehicle hotspot name when I search for Wi-Fi networks on my cell phone or other device?

- Make sure the vehicle hotspot visibility is on.
- Check what frequency the hotspot is transmitting in the vehicle hotspot settings menu. If the frequency is 5 GHz and your device cannot see the network, change the frequency to 2.4 GHz.
- The system does not provide a vehicle hotspot at this time.

How do I remove the vehicle from the vehicle network carrier's account?

- Contact your vehicle network carrier.

Audio System

AUDIO SYSTEM PRECAUTIONS



WARNING: Driving while distracted can result in loss of vehicle control, crash and injury. We strongly recommend that you use extreme caution when using any device that may take your focus off the road. Your primary responsibility is the safe operation of your vehicle. We recommend against the use of any hand-held device while driving and encourage the use of voice-operated systems when possible. Make sure you are aware of all applicable local laws that may affect the use of electronic devices while driving.

Listening to loud audio for long periods of time could damage your hearing.

IDENTIFYING THE AUDIO UNIT



Depending on your vehicle options, the controls may look different from what you see here.

SWITCHING THE AUDIO UNIT ON AND OFF



Press the button on the volume control.

SELECTING THE AUDIO SOURCE

1. Select **Sources**.
2. Select the desired source by pressing the tile on the touchscreen.

MEDIA CONTROL BUTTONS



Press to play a track. Press again to pause the track.

Note: *Not all sources can be paused.*



Press the button to skip to the next track.

Press and hold the button to fast forward through the track.



Press the button once to return to the beginning of a track. Repeatedly press the button to return to previous tracks.

Press and hold the button to fast rewind through the track.



Press the button on the touchscreen to switch shuffle mode on or off.

Note: *Not all sources have shuffle mode.*



Press the button on the touchscreen to change repeat mode.

Note: *Not all sources have repeat mode.*

Audio System

ADJUSTING THE VOLUME

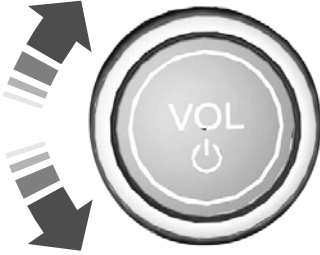

Turn to adjust the volume.

Some vehicles may be able to adjust the volume using buttons on the steering wheel.

SETTING A MEMORY PRESET

1. Select a station or channel.
2. Press and hold a memory preset button on the touchscreen.

Note: *The audio mutes briefly while the system saves the preset and returns once it is stored.*

Note: *You can save presets from multiple sources to the memory preset bar.*

MUTING THE AUDIO



Press to mute the signal. Press again to restore the signal.

Note: *The mute function is only available for sources that cannot be paused.*



Press the button on the steering wheel to mute the signal. Press again to restore the signal.

Note: *If the mute button is not available, you can mute the audio system by decreasing the volume to 0.*

ADJUSTING THE SOUND SETTINGS

To access the sound settings menu:

1. From the settings menu, press Sound.

From the menu, you can adjust the following:

- Tone settings.
- Balance and fade.
- Speed compensated volume.
- Volume settings.
- Sound mode/Occupancy mode

Note: *Depending on your vehicle options, not all settings are available.*

SETTING THE CLOCK AND DATE

1. Press **Settings** on the touchscreen.
2. Press **Clock**.
3. Set the time.

Note: *The AM and PM options are not available if 24-hour mode is on.*

Switching Auto Time Updates On and Off

1. Press **Settings** on the touchscreen.
2. Press **Clock**.
3. Switch **Auto Time Update** on or off.

Audio System

AM/FM RADIO

AM/FM RADIO LIMITATIONS

The further you travel from an AM or FM station, the weaker the signal and the weaker the reception.

Hills, mountains, tall buildings, bridges, tunnels, freeway overpasses, parking garages, dense tree foliage and thunderstorms can interfere with the reception.

When you pass a ground-based broadcast repeating tower, a stronger signal may overtake a weaker one and result in the audio system muting.

SELECTING A RADIO STATION

Manually Selecting a Radio Station

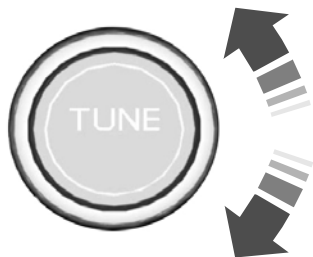

Turn to search through the radio frequency band.

Using Direct Tune

1. Press **Direct Tune** to open the number pad.
2. Enter the station you prefer.

Note: You can only enter a valid station for the audio source you are currently listening to.

Using Seek



Press either button. The system stops at the first station it finds in that direction.



Using the Station List

1. Press **Browse**.

Note: Available on FM radio only.

2. Press a station.

DIGITAL RADIO (IF EQUIPPED)

WHAT IS DIGITAL RADIO

HD Radio™ technology is the digital evolution of analog FM radio.

For additional information, visit www.HDRadio.com.

HD Radio Technology is manufactured under license from iBiquity Digital Corporation and foreign patents. HD Radio and the HD and HD Radio logos are proprietary trademarks of XPERI. The vehicle manufacturer and XPERI are not responsible for the content sent using HD Radio technology. Content may be changed, added or deleted at any time at the station owner's discretion.

HOW DOES DIGITAL RADIO WORK

Your system has a special receiver that allows it to receive digital broadcasts in addition to analog broadcasts.

Audio System

HD1 signifies the main programming status and is available in both analog and digital broadcasts. Other multicast stations are only available digitally and could contain new or different content.

Note: *When the system first receives an HD1 station, it plays the station in the analog version until it verifies the station is an HD Radio station. Then it shifts to the digital version.*

Note: *There is an audio mute delay when switching to an HD2 or HD3 station because the system has to reacquire and decode the digital signal.*

DIGITAL RADIO LIMITATIONS

If you are outside the reception area, the system could not work.

If you are on the fringe of the reception area, the station could mute due to weak signal strength.

Note: *If you are listening to HD1, the system changes back to the analog broadcast until the digital broadcast is available again. If you are listening to any other multicast channels, the station mutes and stays muted unless it is able to connect to the digital signal again.*

Depending on the station quality, you could hear a slight sound change when the station changes between analog and digital audio.

You cannot access a saved HD station if your vehicle is outside the station's reception area.

SWITCHING DIGITAL RADIO RECEPTION ON AND OFF

1. From the settings menu, press Radio. See **Center Display** (page 558).
2. Switch HD Radio on or off.

DIGITAL RADIO INDICATORS

HD Radio Indicator

The indicator appears when HD Radio is on and you tune to a station broadcasting HD Radio technology.



The color of the indicator changes to indicate the system status.

Gray indicates the system is acquiring a digital station.

Orange indicates digital audio is playing.

Multicast Indicator

The multicast indicator appears if the current station is broadcasting multiple digital broadcasts. The highlighted numbers indicate additional digital channels available.

Note: *For stations that have more than one HD multicast, the HD indicator and radio text appears as a button. Press the button to cycle through all of the HD stations on that specific frequency.*

SATELLITE RADIO (IF EQUIPPED)

WHAT IS SATELLITE RADIO

Your factory-installed SiriusXM radio system includes a limited subscription term, which begins on the date of sale or lease of your vehicle. See an authorized dealer for availability.

Audio System

For additional information about extended subscription terms, visit www.SiriusXM.com in the United States, www.SiriusXM.ca in Canada, or call SiriusXM at 1-888-539-7474.

Note: *SiriusXM reserves the unrestricted right to change, rearrange, add or delete programming including canceling, moving or adding particular channels, and its prices, at any time, with or without notice to you. Neither SiriusXM and its affiliates nor Ford Motor Company and its affiliates will be liable to you or any third party for any such modification, suspension or termination.*

SATELLITE RADIO LIMITATIONS

For optimal reception performance, keep the antenna clear of snow and ice build-up and keep luggage and other material as far away from the antenna as possible. Placing luggage over the antenna may reduce performance. Factory-installed and aftermarket vehicle structures including, but not limited to, roof racks and soft top roofs in a partially open position could reduce reception performance.

Hills, mountains, tall buildings, bridges, tunnels, freeway overpasses, parking garages, dense tree foliage and thunderstorms can interfere with your reception.

When you pass a ground-based broadcast-repeating tower, a stronger signal may overtake a weaker one and could result in the audio system muting. Your display could show an error message to indicate the interference.

LOCATING THE SATELLITE RADIO IDENTIFICATION NUMBER

1. Select SiriusXM as the audio source.
2. Tune to channel 0.

SELECTING A CHANNEL

Manually Selecting a Channel



Press the button to find the previous or next available radio channel.



Linear Tuner

The linear tuner is displayed when manually selecting a channel. You can swipe left or right on the linear tuner carousel to navigate through the channel list. Tap on a channel title to listen to it.

Using Direct Tune

1. Press the channel up or down button to open the linear tuner screen.
2. Press **Direct Tune** to open the number pad.
3. Enter the channel you prefer.

Using Browse

1. Press **Browse**.
2. Select a channel.

SATELLITE RADIO SETTINGS

Subscription

Your subscription status is displayed. You can subscribe or manage your subscription directly from the touchscreen.

SiriusXM Favorites

While you are listening to SiriusXM, you can save favorites by:

Audio System

- Tapping the currently tuned channel or show logo on the SiriusXM audio screen.
- Tuning to a channel or show you want to save as a favorite. Navigate to the SiriusXM Favorites screen and press the Add Current button. The currently tuned channel or show is saved as a favorite.
- Saving a radio preset. This saves the currently tuned SiriusXM channel or show as a favorite

Note: *Requires a trial or active subscription to use.*

Listening History

Listening history is a list of recently listened to SiriusXM content. You can view, manage and reset the listening history using the controls on the touchscreen.

Note: *Requires a trial or active subscription to use.*

Help and Support

You can contact SiriusXM Customer Care directly from the operating system and view information required to manage your SiriusXM account.

Audio System

AUDIO SYSTEM – TROUBLESHOOTING

AUDIO SYSTEM – INFORMATION MESSAGES

Satellite Radio Troubleshooting

Error Message	Potential Effects	Recommended Action
Connectivity Disabled	Internet streaming and On Demand shows are unavailable and some SiriusXM features are disabled.	Internet connectivity is turned off. See Connected Vehicle (page 543).
No Internet	Audio system may mute. Switch to Satellite button may be displayed on the SiriusXM audio screen if the channel is also available via satellite.	SYNC attempts to connect. See Satellite Radio Limitations (page 552). Switch to a satellite connection for the current channel if the option is available.
No Satellite Signal	Audio system may mute. Switch to Internet button may be displayed on the SiriusXM audio screen if the channel is also available via streaming.	Antenna may be obstructed or satellite reception is weak in your location. See Satellite Radio Limitations (page 552). Switch to an internet connection for the current channel if the option is available.
Slow Network Connection	Audio system may mute while the audio attempts to load.	Allow some time for the audio to load or tune to a different channel.
Channel Unavailable	Audio system may mute. Radio may tune to a different channel.	A temporary update may be in progress. Allow some time before retrying to tune to the channel. If the issue continues, the channel may no longer be available.
Episode Unavailable	Audio system may mute. Radio may tune to a different channel.	A temporary update may be in progress. Allow some time before retrying to play the episode. If the issue continues, the episode may no longer be available.

Audio System

Error Message	Potential Effects	Recommended Action
Something went wrong	Audio system may mute. Radio may tune to a different channel.	Allow some time and retry the action.
Subscribe to Listen	Cannot listen to selected content. Content may appear grayed out and some features may be disabled.	<p>Your subscription has expired or you have not yet subscribed for access to the listed content. Navigate to Subscription under the Satellite Radio Settings menu. If you have an active subscription which includes the listed channel or content and you see this error, you may need to refresh your radio. To refresh your SiriusXM radio, visit www.siriusxm.com/refresh in the US, or www.siriusxm.ca/refresh in Canada.</p> <p>You may need to provide your SiriusXM Radio identification number. See Locating the Satellite Radio Identification Number (page 552).</p>

Audio System

Error Message	Potential Effects	Recommended Action
Upgrade to Listen	Cannot listen to selected content. Content may appear grayed out and some features may be disabled.	Your subscription does not include access to the listed content. You may need to upgrade your subscription. Navigate to Subscription under the Satellite Radio Settings menu. If you have an active subscription which includes the listed channel or content and you see this error, you may need to refresh your radio. To refresh your SiriusXM radio, visit www.siriusxm.com/refresh in the US, or www.siri-usxm.ca/refresh in Canada. You may need to provide your SiriusXM Radio identification number. See Locating the Satellite Radio Identification Number (page 552).
Location Restricted Content	Audio may mute. Not available in your location or Unable to determine your location may be displayed.	Content is not available in your location or SiriusXM is unable to determine your location. Tuning to a different channel may resolve the issue.
Channel Blocked	Audio may mute. Radio may tune to a different channel.	The Block Explicit Content filter is turned on. Navigate to Listener Settings under the Satellite Radio Settings menu to access the Block Explicit Content filter. Navigate to Listener Settings. See Satellite Radio Settings (page 552).
Antenna Problem or Hardware Problem	Audio may mute. Access to SiriusXM features may be unavailable.	If issue persists, you may need to visit an authorized dealer for service.

Audio System

Error Message	Potential Effects	Recommended Action
SiriusXM Updating...	Audio may mute.	Allow SiriusXM some time to complete updating.
Loading...	Audio may mute. Content may be temporarily unavailable while loading.	No action necessary. If loading time is longer than usual, See Satellite Radio Settings (page 552).
SiriusXM Loading...	Audio may mute. Content and controls may be temporarily unavailable.	No action necessary. Allow SiriusXM some time to finish loading.

Center Display

CENTER DISPLAY OVERVIEW



WARNING: Driving while distracted can result in loss of vehicle control, crash and injury. We strongly recommend that you use extreme caution when using any device that may take your focus off the road. Your primary responsibility is the safe operation of your vehicle. We recommend against the use of any hand-held device while driving and encourage the use of voice-operated systems when possible. Make sure you are aware of all applicable local laws that may affect the use of electronic devices while driving.

For your safety, features that are not critical while driving are not available when the vehicle is moving at or above 8 km/h (5 mph).

Note: Illustrations are provided for conceptual understanding only and may appear differently on your vehicle.

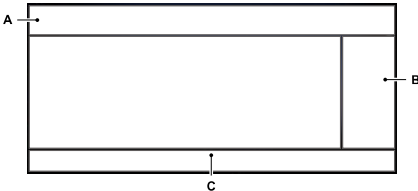

- A Status bar. See **Status Bar** (page 558).
- B Information on demand screen. See **Information On Demand Screen** (page 559).
- C Feature bar. See **Feature Bar** (page 559).

STATUS BAR

The status bar appears at the top of the display. The following buttons and icons can appear in the status bar.

Note: Some buttons and icons may not apply to your vehicle or may not appear exactly as shown.

Alexa Built-In



Press to set up Alexa. See **Alexa Built-In** (page 564).

Wireless Charging



Wireless charging active.



Device connected and not charging.

Traffic Announcements



Traffic announcements are turned on but are not supported by the selected station.



Traffic announcements are turned on and supported by the selected station but are not active.



Traffic announcements are active.

Note: If no traffic announcement icons are displayed, traffic announcements are turned off.

Vehicle Data



Wi-Fi available.



Wi-Fi connected.

Center Display



Vehicle data sharing on.



Vehicle data sharing off.



Vehicle location sharing on.



Vehicle data and vehicle location sharing on.

Outside Air Temperature



Outside air temperature is active.

Audio System



Audio system muted.

Connected Device



Cell phone microphone muted.



Phone call in progress.



Media player connected using **Bluetooth®**.



Cell phone network signal strength.



Cell phone roaming.



Text message received.



Unread email message.



Automatic crash notification system off.



Cell phone battery status.

Software Updates



Press to see details about software updates. See **Vehicle Software Updates** (page 578).

Back Button



Some screens have a back button in the top corner. Press the button to return to the previous screen.

INFORMATION ON DEMAND SCREEN

The information on demand screen displays cards on the side of the display and allows you to see information from different features.



Press the button to view the next card.



Press the button to view the previous card.



Press the button to view available cards.

On some screens, you can swipe a card toward the center of the screen to move the content into the main screen.

FEATURE BAR

The feature bar is located on the bottom of the display and allows you to access vehicle features.

Center Display

Audio



Press to use the radio, a USB, a media player or a **Bluetooth®** device.

Phone



Press to make calls and access the phonebook on your cell phone. See **Phone** (page 566).

Navigation



Press to use the navigation system. See **Navigation** (page 575).

Favorite



Press to replace this button with a shortcut to a feature or setting.

Apps



Press to see a list of apps. To open an app, select the app.

Settings



Press to access the settings menu. See **Settings** (page 560).

Features



Press to view features.

Note: *The icon may be different depending on your vehicle.*

SETTINGS

1.



Press the button in the feature bar to access the settings menu.

2. Select the required tile to access specific settings.

You can change the display language and other measurement units under the General menu.



If you see this icon next to a menu option, press it for more information.

Display Settings

From the display menu you can do the following:

- Switch the calm screen on.
- Manually adjust the screen brightness.
- Set the display mode.

Touchscreen Brightness

To manually adjust the screen brightness, use the plus or minus buttons.

Note: *The display brightness is limited if the settings of the instrument panel lighting brightness are set to the highest or lowest setting.*

DRIVER ASSISTANCE MENU

To access the driver assistance menu:

1.



Press the button in the feature bar to access the features menu.

Note: *The icon may be different depending on your vehicle.*

2. Press Driver Assistance.

REBOOTING THE CENTER DISPLAY

You can reboot the center display using the controls on the steering wheel.

Center Display

1. Simultaneously press and hold the seek forward and audio system power button for 10 seconds.

Voice Interaction

FORD ASSISTANT

USING FORD ASSISTANT

The digital assistant allows you to control vehicle features using conversational requests.

To begin a voice interaction using the wake word, say the selected wake word, then say your command.



Press the voice interaction button on the steering wheel. A tone sounds before you can say your command.

Note: You may need to enable your vehicle's modem to use certain voice commands. See **Enabling and Disabling the Modem** (page 543).

Voice Command Examples

To see examples of what voice commands you can use with different features:



Press the button on the touchscreen.

1. Press **Ford Assistant**.
2. Press **Voice Command Help**.
3. Select a feature.

FORD ASSISTANT SETTINGS

To access the settings menu:



Press the button on the touchscreen.

1. Press **Ford Assistant**.

From the settings menu you can do the following:

- Switch listen for wake word on or off.
- Set the preferred wake word.
- Switch advanced mode on or off.

- Switch phone confirmation on or off.
- Switch the commands list on or off.
- View the commands help menu.



Press the button next to a menu option for more information.

FORD ASSISTANT – FREQUENTLY ASKED QUESTIONS

Why does the system not understand what I am saying?

- You are speaking too soon. When using the button of the steering wheel, wait for the tone before you speak.

Why does the system not understand the name of a track or artist?

- **Bluetooth®** does not support voice commands. Connect your device to a USB port.
- You are not saying the name exactly as it appears on your device. Say the name of the track or artist exactly as it appears on your device. Spell out any abbreviations in the name.
- The system does not recognize some special characters contained in the name of a song or artist, for example *, - or +. Rename the files on your device or use the touchscreen to select and play the track.

Voice Interaction

Why does the system not understand the name of a contact in the phonebook on my device and calls the wrong contact?

- You are not saying the name exactly as it appears on your device. Say the first and last name of the contact exactly as it appears on your device. Spell out any abbreviations in the name.
- The name contains special characters, for example *, - or +. Rename the contact on your device or use the touchscreen to select and call the contact.

Why does the system not understand foreign names of contacts in the phonebook on my device?

- The system applies phonetic pronunciation rules of the selected language to the names of contacts in the phonebook on your device. Select the name of the contact on the touchscreen and use the Hear it option to get an idea of how the system expects you to pronounce it.

Why do the system voice prompts and the pronunciation of some words not seem accurate?

- The system uses text-to-speech technology and a synthetically generated voice rather than a pre-recorded human voice.

Alexa Built-In (If Equipped)

WHAT IS ALEXA BUILT-IN

Alexa Built-In allows you to use Alexa in your vehicle for auto-specific use cases on the road and gives you access to an ever-evolving number of skills that help to make your life more productive, entertaining, and connected while using your vehicle.

ALEXA BUILT-IN REQUIREMENTS

To use Alexa, all of the following must occur:

- Your vehicle modem is enabled.
- You are signed in to an existing Amazon account.
- Vehicle location services are enabled.
- Vehicle connectivity and vehicle data sharing is enabled.

Note: *Support and functionality may vary based on the country in which your FordPass account is registered.*

SIGNING IN TO YOUR ACCOUNT



Press the button in the status bar and follow the on-screen prompts.

To sign in using the settings menu:

1. Press **Settings** on the touchscreen.
2. Press **Amazon Alexa**.
3. Press **Get Started**.
4. Sign in to your account by either scanning the QR code or entering the on-screen code into the Amazon website.
5. Once signed in, follow the on-screen prompts.

6. When complete, the vehicle informs you that Alexa is ready to be used in the vehicle.

Signing Out of Your Account

1. Press **Settings** on the touchscreen.
2. Press **Amazon Alexa**.
3. Press **Sign Out**.

USING ALEXA BUILT-IN

To use Alexa, say “Alexa” or press the voice interaction button on the steering wheel and then say “Alexa” to invoke Alexa to start listening.

Note: *If the wake word is not enabled, you can only use the voice interaction button.*

You can use Alexa for the following and more:

- Entertainment.
- Hands-free calling.
- Traffic and navigation.
- Vehicle controls.
- Smart home device control.
- Weather and news information.

ALEXA BUILT-IN SETTINGS

Enabling the Wake Word

1. Press **Settings** on the touchscreen.
2. Press **Amazon Alexa**.
3. Switch **Listen for Wake Word** on or off.

Note: *If the wake word is not enabled, you can only use the voice interaction button.*

Contact List

Displays a list of connected phones and contact sharing status for each phone.

To change the contact sharing status:

Alexa Built-In (If Equipped)

1. Press **Settings** on the touchscreen.
2. Press **Amazon Alexa**.
3. Press **Contact List**.
4. Enable or disable sharing for each phone.

Note: *You can share contacts from more than one phone at a time.*

Things to Try

Learn more about what you can do with Alexa by browsing the things to try.

1. Press **Settings** on the touchscreen.
2. Press **Amazon Alexa**.
3. Press **Things to Try**.

Phone

PHONE PRECAUTIONS



WARNING: Driving while distracted can result in loss of vehicle control, crash and injury. We strongly recommend that you use extreme caution when using any device that may take your focus off the road. Your primary responsibility is the safe operation of your vehicle. We recommend against the use of any hand-held device while driving and encourage the use of voice-operated systems when possible. Make sure you are aware of all applicable local laws that may affect the use of electronic devices while driving.

CONNECTING YOUR PHONE

Go to the settings menu on your device and switch **Bluetooth®** on.



Press the phone option on the feature bar.

1. Press **Add Phone**.

Note: A prompt alerts you to search for your vehicle on your cell phone.

2. Select your vehicle on your cell phone.

Note: A number appears on your cell phone and on the touchscreen.

3. Confirm the number on your cell phone matches the number on the touchscreen.

Note: The touchscreen indicates that you have successfully paired your cell phone.

4. Approve phonebook download request on your cell phone.

PHONE MENU

This menu becomes available after pairing a phone.

Recent Call List

Display and select an entry from a list of previous calls.

Contacts

Display a smart search form to look up your contacts. Use the List button to alphabetically sort your contacts.

Favorites

Display the list of favorite contacts that are set up on your phone.

Messaging

Displays the list of text messages to read, listen to, or respond to.

Email

Displays the list of emails to read, listen to, or respond to.

Phone List

Display the list of paired or connected devices that you can select.

Note: Up to 12 devices can be stored.

Do Not Disturb

Reject incoming calls and switch ring tones and alerts off.

Phone Keypad

Directly dial a number.

Phone

Voice Control

Press the button and say a command to use the Google or Siri voice assistant available on your connected phone to access supported features.

Note: *Some features under the phone menu may not be available if the feature is not supported through the phone.*

Phone

MAKING AND RECEIVING A PHONE CALL

Making Calls

To call a number in your contacts, select:

Menu Item	Action and Description
Contacts	You can then select the name of the contact you want to call. Any numbers stored for that contact display along with any stored contact photos. You can then select the number that you want to call. The system begins the call.

To call a number from your recent calls, select:

Menu Item	Action and Description
Recent Call List	You can then select an entry that you want to call. The system begins the call.

To call a number from your favorites, select:

Menu Item	Action and Description
Favorites	You can then select an entry that you want to call. The system begins the call.

To call a number that is not stored in your phone, select:

Menu Item	Action and Description
Phone Keypad	Select the digits of the number you wish to call.
Call	The system begins the call.

Pressing the backspace button deletes the last digit you typed.

Receiving Calls

During an incoming call, an audible tone sounds. Caller information appears in the display if it is available.

To accept the call, select:

Menu Item
Accept

Note: You can also accept the call by pressing the phone button on the steering wheel.

To reject the call, select:

Menu Item
Reject

Ignore the call by doing nothing. The system logs it as a missed call.

During a Phone Call

During a phone call, the contacts name and number display on the screen along with the call duration.

The phone status items are also visible:

- Signal Strength.
- Battery.

You can select any of the following during an active phone call:

Phone

Item	
End Call	Immediately end a phone call. You can also press the button on the steering wheel.
Keypad	Press this to access the phone keypad.

Item	
Mute	You can switch the microphone off so the caller does not hear you.
Privacy	Transfer the phone call audio to the cell phone or back to the touchscreen.

SENDING AND RECEIVING A TEXT MESSAGE

Menu Item	Description
Hear It	Hear the text message.
View	View the text message.
Call	Call the sender.
Reply	Reply to the text message with a standard text message.

Phone

SWITCHING TEXT MESSAGE NOTIFICATION ON AND OFF

IOS

1. Go to the settings menu on your cell phone.
2. Select **Bluetooth®**.
3. Select the information icon to the right of your vehicle.
4. Switch text message notification on or off.

Android

1. Go to the settings menu on your cell phone.
2. Select **Bluetooth®**.
3. Select the profiles option.
4. Select the phone profile.
5. Switch text message notification on or off.

ENABLING APPS ON A MOBILE DEVICE

When you start an app through the system for the first time, you could be asked to grant certain permissions. You can review and change the permissions that you have granted at any time when your vehicle is not moving. We recommend that you check your data plan before using your apps through the system. Using them could result in additional charges. We also recommend that you check the app provider's terms and conditions and privacy policy before using their app. Make sure that you have an active account for apps that you want to use through the system. Some apps work with no setup. Others require you to configure some personal settings before you can use them.

Enabling Apps on an iOS Device



Select the apps option on the feature bar.

1. Select Mobile Apps Help.
2. Follow the instructions to pair and connect your device via **Bluetooth®** or with a USB cable.
3. Start the apps on your device that you want to use.
4. Select the app that you want to use on the touchscreen.

Note: Some apps may run through Apple CarPlay if it is enabled.

Note: Closing an app on your device closes it on the touchscreen.

Note: For troubleshooting assistance select Mobile Apps List under Mobile Apps Help.

Enabling Apps on an Android Device



Select the apps option on the feature bar.

1. Select Mobile Apps Help.
2. Follow the instructions to pair and connect your device via **Bluetooth®** or with a USB cable.
3. Start the apps on your device that you want to use.
4. Select **Find Mobile Apps**.
5. Select the app that you want to use on the touchscreen.

Note: Some devices may lose the ability to play music over USB when Mobile Apps are enabled.

Note: Some apps may run through Android Auto if it is enabled.

Note: Closing an app on your device closes it on the touchscreen.

Phone

Note: For troubleshooting assistance select *Mobile Apps List* under *Mobile Apps Help*.

SWITCHING APPLE CARPLAY ON AND OFF

Enabling Apple CarPlay with USB

1. Connect your device to a USB port.
2. Follow the instructions on your device and the touchscreen.

Note: Selecting *Enable Wireless CarPlay* on your device prepares the device for *wireless CarPlay* when you reenter the vehicle.

Enabling Apple CarPlay with Wireless

1. Pair your device to **Bluetooth®**.
2. Follow the instructions on your device and the touchscreen.

Disabling Apple CarPlay



Select the settings option on the feature bar.

1. Press Phone List.
2. Select your device from the list.
3. Press Disable.

Re-Enabling Apple CarPlay



Select the settings option on the feature bar.

1. Press Phone List.
2. Select your device from the list.
3. Press Connect to Apple CarPlay.

SWITCHING ANDROID AUTO™ ON AND OFF

Enabling Android Auto with USB

(If Equipped)

1. Connect your device to a USB port.
2. Follow the instructions on the touchscreen.

Note: *Certain features of the system are not available when you are using Android Auto.*

Enabling Android Auto with Wireless

1. Pair your device to **Bluetooth®**.
2. Follow the instructions on your device and the touchscreen.

Note: *Certain Android™ devices do not support Android Auto Wireless. Check your Android OS version for compatibility.*

Disabling Android Auto



Select the settings option on the feature bar.

1. Press Phone List.
2. Select your device from the list.
3. Press Disable.

Re-Enabling Android Auto



Select the settings option on the feature bar.

1. Press Phone List.
2. Select your device from the list.
3. Press Connect to Android Auto.

Bluetooth®

CONNECTING A BLUETOOTH® DEVICE

1. From the settings menu, press Connectivity. See **Center Display** (page 558).
2. Press Phone list.
3. Press Add phone.

Note: A prompt alerts you to search for your vehicle on your device.

1. Select your vehicle on your device.

Note: A number appears on your device and on the touchscreen.

2. Confirm that the number on your device matches the number on the touchscreen.

Note: The touchscreen indicates that you have successfully paired your device.

The **Bluetooth®** word mark and logos are registered trademarks owned by **Bluetooth SIG, Inc.** and any use of such marks by Ford Motor Company is under license. Other trademarks and trade names are those of their respective owners.

PLAYING MEDIA USING BLUETOOTH®



WARNING: Driving while distracted can result in loss of vehicle control, crash and injury. We strongly recommend that you use extreme caution when using any device that may take your focus off the road. Your primary responsibility is the safe operation of your vehicle. We recommend against the use of any

hand-held device while driving and encourage the use of voice-operated systems when possible. Make sure you are aware of all applicable local laws that may affect the use of electronic devices while driving.

Connect your device.



Press the audio button on the feature bar.



Press **Sources**.



Press the **Bluetooth®** option.



Press to play a track. Press again to pause the track.



Press to skip to the next track.

Press and hold to fast forward through the track.



Press once to return to the beginning of a track. Repeatedly press to return to previous

tracks.

Press and hold to fast rewind through the track.

Personal Profiles

HOW DO PERSONAL PROFILES WORK

You can create multiple personal profiles enabling users to personalize vehicle settings such as seats and mirrors, as well as non-positional settings like radio, navigation and driver assist system settings. Positional settings are saved by holding a memory function button. Non-positional settings are saved when you change a setting while a profile is active.

ENABLING OR DISABLING PERSONAL PROFILES

1. Press Settings on the touchscreen.
2. Press Personal Profiles.
3. Switch Personal Profiles on or off.

When enabled:

- Unlocking a door with a remote control or mobile device that is not linked to a driver profile does not change the active profile, but remains in the last known profile. It does not change the positional settings.
- Pressing a memory seat button that is not linked to a driver profile or saved to a preset setting does not change the active profile, but remains in the last known profile. It does not change the positional settings.
- Pressing a memory seat button that is not linked to a driver profile but is saved to a preset setting does not change the active profile, but remains in the last known profile. It recalls the positional settings that you saved to that memory seat button.

When disabled:

- Unlocking a door with a remote control or mobile device does not recall any non-positional settings but still recalls positional settings from the driver profile which the remote control or mobile device is linked to.
- Pressing a memory seat button that is not linked to a driver profile or saved to a preset setting does not change the positional or non-positional settings.
- Pressing a memory seat button that is linked to a driver profile or has saved to a preset setting recalls the positional settings that you saved to that memory seat button.

CREATING A PERSONAL PROFILE

You can create one profile for each preset memory seat button. There is also a guest profile.

Note: *The guest profile consists of existing settings when there is no driver profile created. After you create a driver profile, the guest profile serves as an additional driver profile.*

1. Press Settings on the touchscreen.
2. Press Personal Profiles.
3. Press Add Profile.
4. Follow the prompts on the display.

LINKING OR UNLINKING A PERSONAL PROFILE

You can link your profile to a remote control so that your settings are activated when you use the remote control to turn on the vehicle.

Personal Profiles

Remote Control

You can save preset memory positions for up to three remote controls by assigning a remote control to a personal profile.

1. Press Settings on the touchscreen.
2. Press Personal Profiles.
3. Select the profile to link or unlink.

Note: *You cannot link a remote control to a guest profile.*

4. Select the remote control to link or unlink.
5. Follow the instructions on the touchscreen.

Note: *If more than one linked remote control is in range, the memory function moves to the settings of the first key to initiate a memory recall.*

SELECTING A PERSONAL PROFILE

You can select a profile using the touchscreen or the preset button you selected when you created your profile.

If you use a linked device, such as a remote control or mobile device, the active profile is set to the linked profile.

To change the active profile:

1. Press Settings on the touchscreen.
2. Press Personal Profiles.
3. Select the profile to use.
4. Press Make Profile Active.

DELETING A PERSONAL PROFILE

1. Press Settings on the touchscreen.
2. Press Personal Profiles.
3. Select the profile to delete.

4. Press Delete Profile.

Navigation (If Equipped)

CONNECTED NAVIGATION (IF EQUIPPED)

Your vehicle may have connected navigation as a free trial after purchase. You require a subscription after the trial expires. For additional information, visit ford.com/connectedservices.

Note: *If you do not sign up or renew your subscription, you can still use navigation through a connected device.*

ACCESSING NAVIGATION



Press the button to access Navigation.

Note: *As the driver, be aware of all local traffic regulations and road attributes, and operate your vehicle in a safe and legal manner.*

NAVIGATION MAP UPDATES

To update your map data over Wi-Fi, your vehicle must be connected to a Wi-Fi access point. For USB updates and other details, contact dealers at 1-866-462-8837 in the United States and Canada, or 800-557-5539 in Mexico.

Note: *If you find map data errors, you may report them by going to www.here.com/mapcreator.*

ADJUSTING THE MAP

ZOOMING THE MAP IN AND OUT

You can use pinch gestures to zoom in and out. Place two fingers on the screen and move them apart to zoom in. Place two fingers on the screen and bring them together to zoom out.

CHANGING THE FORMAT OF THE MAP



Press the Menu button.

1. Press the Map Orientation tile.
2. Select a map orientation.

LIVE TRAFFIC

WHAT IS LIVE TRAFFIC

You can observe real-time road congestion when live traffic is on.

SWITCHING LIVE TRAFFIC ON AND OFF



Press the Menu button.

1. Press the Traffic on Map tile.
2. Press Traffic on or Traffic Off.

SETTING A DESTINATION

SETTING A DESTINATION USING THE TEXT ENTRY SCREEN

1. Press the search bar at the top of the screen.
2. Enter your destination using the keyboard.
3. Press Search.
4. Select a destination from the list.
5. Press Start to begin navigation.

Navigation (If Equipped)

SETTING A DESTINATION USING THE MAP SCREEN

Press and hold on the map to place a pin at that location. Information about the location of the pin appears on the screen.



Press the button to begin navigation to the pin.

SETTING A DESTINATION USING A PREDICTIVE DESTINATION

Press the predicted destination card on the screen to navigate to it. These appear when the navigation system has learned your driving habits.

SETTING A DESTINATION USING A RECENT DESTINATION



Press the button.

Press a destination from the list.

Note: You can also use the search button to view recent destinations.

SETTING A DESTINATION USING A SAVED DESTINATION

Press the star icon next when viewing location details to save the location.



Press the button.

Press a destination from the list.

Note: You can also use the search button to view saved destinations.

SETTING A DESTINATION USING A POINT OF INTEREST

Press a point of interest icon on the map. Information about the location of the point of interest appears on the screen.



Press the button to begin navigation to the point of interest.

Note: You can also use the search button to view points of interest.

WAYPOINTS

ADDING A WAYPOINT

1. Press the search button during an active navigation session.
2. Enter your destination.
3. Select your destination from the list.
4. Follow the prompts on the screen to add a waypoint.

EDITING WAYPOINTS

1. Press the waypoint you would like to edit.
2. Select an option to reorder or delete the waypoint.

ROUTE GUIDANCE

ADJUSTING THE GUIDANCE PROMPT VOLUME

Turn the volume control when a guidance prompt plays to adjust the volume.

REPEATING AN INSTRUCTION

Press the turn indicator to hear the last voice instruction.

Navigation (If Equipped)

CANCELING ROUTE GUIDANCE



Press the button to cancel route guidance to the selected location.

TRAILER TOWING NAVIGATION

The system calculates the best route for trailer towing by avoiding dangerous road conditions based on the dimensions of your trailer.

Note: *This feature is only available if you properly attach the trailer to your vehicle.*

Switching Trailer Towing Navigation On and Off

1. Press the **Navigation** button on the feature bar.
2. Press the **Menu** button.
3. Press **Trailer Routing**.
4. Switch **Trailer-optimized Routing** on or off.

Entering Trailer Dimensions

1. Press the **Navigation** button on the feature bar.
2. Press the **Menu** button.
3. Press **Trailer Routing**.
4. Press **Towing Menu**.
5. Press **Add Trailer**.
6. Follow the instructions on the screen to enter the type and dimensions of the trailer into the system.

Vehicle Software Updates

This introduces new features and provides updates to the vehicle's software systems. Make sure to switch Automatic Updates on, set a recurring update schedule and connect your vehicle to Wi-Fi. Updates could take longer when not connected to Wi-Fi or could not download at all. See **Connecting the Vehicle to a Wi-Fi Network** (page 543).

Your vehicle may be able to receive drivable software updates, non-drivable software updates or both. Drivable software updates happen during normal vehicle usage and require limited input from you. You are notified on your touchscreen and connected device prior to a non-drivable update.

Most non-drivable updates complete in less than 30 minutes, although some updates could take up to a few hours.

You are notified of vehicle software update status on to the top left of touchscreen. You can also see the notifications in your connected device. See **Software Update Indicators** (page 579).

Vehicle Software Update Requirements

Non-drivable software updates do not install if any of the following occur:

- Your vehicle is running.
- Your vehicle is switched on.
- Your vehicle is not parked.
- The 12 V battery charge is too low.
- The hazard indicators are switched on.
- The alarm is sounding.
- The doors are open.
- The parking lamps are switched on.
- You are pressing the brake pedal.
- An emergency call is in process.
- Your vehicle is in limp home mode.

Vehicle Software Update Limitations

Once you begin a non-drivable software update, you cannot:

- Cancel the update.
- Enter your vehicle unless you have a key blade.
 - You can open the doors using the mechanical latch if child locks are not on.
- Use the remote control to lock, unlock or start your vehicle.
- Drive your vehicle.
- Charge your vehicle.
 - Charging resumes once the update completes.

SOFTWARE UPDATE SETTINGS

To access the Software Updates menu:

1. Press Settings.
2. Press Software Updates.

You can do the following in the Software Updates menu:

- Switch Automatic Updates on and off.
- Schedule and install software updates.
- View software update details.



Press the button next to a menu option for more information.

Switching Automatic Updates On and Off

Your vehicle may come with Automatic Updates switched on or off.

Vehicle Software Updates

Switch Automatic Updates on. When Automatic Updates is set to on, you agree that software updates may be automatically delivered without any further notice or additional consent from you.

To make sure your vehicle always has the latest software, which could include security or other enhancements, we recommend switching Automatic Updates On.

Note: *Software updates require approval to download or install with Automatic Updates switched off.*

Scheduling and Installing Software Updates

Scheduling Software Updates

From the Software Updates menu:

1. Press Schedule Updates.
2. Selecting from a list of available timings or customizing gets auto saved.

Note: *Depending on your vehicle options some vehicles have the save option.*

The more days that updates are scheduled, the more frequently your vehicle installs new updates. We recommend selecting a time you normally do not need your vehicle.

Note: *The schedule you set is recurring. If Automatic Updates is on, every time a non-drivable update is available, it installs on this schedule unless you change it. You are notified on your touchscreen prior to a non-drivable update, with an option to reschedule it.*

Installing Software Updates

Using the Status Bar

1. Press the Software Update indicator on your touchscreen when it appears.
2. Follow the instructions on the touchscreen.

Using the Touchscreen

From the Software Updates menu:

1. Press Updates Details.
2. Press Update Now.

Viewing Software Update Details

From the Software Updates menu, press Update Details.

SOFTWARE UPDATE INDICATORS

You can press the indicators in the status bar when they appear for more information.



Vehicle software update reminder, schedule required, confirmation of default schedule required, or consent required.



Vehicle software update canceled, update not successful, or precondition not met.



Vehicle software update successful.

Vehicle System Reset

PERFORMING A SYSTEM RESET

1. Press **Settings** on the touchscreen.
2. Press **General**.
3. Press **Reset**.

You can perform multiple resets from this menu.



Press the button next to a menu option for more information.

Accessories

For a complete listing of the accessories that are available for your vehicle, please contact your authorized dealer or visit the online store web site:

Web Address (United States)
www.Accessories.Ford.com

Web Address (Canada)
www.Accessories.Ford.ca

We will repair or replace any properly authorized dealer-installed Ford Original Accessory found to be defective in factory-supplied materials or workmanship during the warranty period, as well as any component damaged by the defective accessories.

We will warrant your Ford Original Accessory through the warranty that provides the greatest benefit:

- 24 months, unlimited mileage.
- The remainder of your new vehicle limited warranty.

Contact an authorized dealer for details and a copy of the warranty.

Ford Licensed Accessories are the accessory manufacturer's designs. The manufacturer develops and therefore warrants Ford Licensed Accessories, and does not design or test these accessories to Ford Motor Company engineering requirements. Contact an authorized Ford dealer for the manufacturer's limited warranty details, and request a copy of the Ford Licensed Accessories product limited warranty from the accessory manufacturer.

For maximum vehicle performance, keep the following information in mind when adding accessories or equipment to your vehicle:

- When adding accessories, equipment, passengers and luggage to your vehicle, do not exceed the total weight capacity of the vehicle or of the front or rear axle (GVWR or GAWR as indicated on the Safety Compliance Certification label). Ask an authorized dealer for specific weight information.
- The Federal Communications Commission (FCC) and Canadian Radio Telecommunications Commission (CRTC) regulate the use of mobile communications systems that are equipped with radio transmitters, for example two-way radios, telephones and theft alarms. Any such equipment installed in your vehicle should comply with Federal Communications Commission (FCC) and Canadian Radio Telecommunications Commission (CRTC) regulations and should be installed only by an authorized dealer.
- An authorized dealer needs to install mobile communications systems. Improper installation may harm the operation of your vehicle, particularly if the manufacturer did not design the mobile communication system specifically for automotive use.
- If you or an authorized Ford dealer add any non-Ford electrical or electronic accessories or components to your vehicle, you may adversely affect battery performance and durability. In addition, you may also adversely affect the performance of other electrical systems in the vehicle.

Auxiliary Switches (If Equipped)

WHAT ARE THE AUXILIARY SWITCHES

The auxiliary switchboard on the overhead console makes aftermarket customization easier with six prewired switches connected to the power distribution box. Each circuit is individually fused for connection of electrical accessories. For more information on connecting accessories to the auxiliary switches, see your authorized dealer or refer to the Super Duty Body Builders Layout Book (BBLB), if available.

For maximum vehicle performance, keep the following information in mind when adding accessories or equipment to your vehicle:

- When adding accessories, equipment, passengers and luggage to your vehicle, do not exceed the total weight capacity of the vehicle or of the front or rear axle (GVWR or GAWR as indicated on the safety compliance certification label). Ask an authorized dealer for specific weight information.
- It is your responsibility to ensure that any equipment you have fitted complies with applicable local legislation.
- An authorized dealer needs to install mobile communication systems. Improper installation may harm the operation of your vehicle, particularly if the manufacturer did not design the mobile communication system specifically for automotive use.
- If you or an authorized dealer add any electrical or electronic accessories or components not produced by us to your vehicle, you may adversely affect battery performance and durability. In addition, you may also adversely affect the performance of the other electrical systems in the vehicle.

LOCATING THE AUXILIARY SWITCHES

The switches are labeled AUX 1 through AUX 6.

The auxiliary switches only operate when the ignition is in the on or off position and the delay accessory is active, whether the engine is running or not.

We recommend that you leave the engine running to maintain battery charge when using the switches for an extended time or when using higher current draw accessories.

When a switch is turned on, the indicator light on the switch illuminates and the circuit provides power to the device wired to that switch.



LOCATING THE AUXILIARY SWITCH WIRING

The sealed blunt cuts are located in the front passenger side wheel well.

Remove the tape to access the individual wire.

Auxiliary Switches (If Equipped)

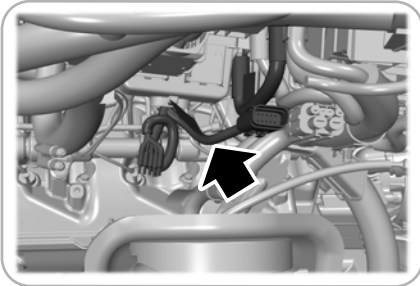
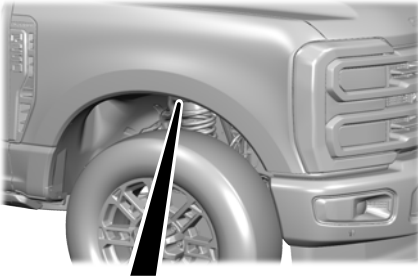

The auxiliary switch relay box is near the under hood fuse box.

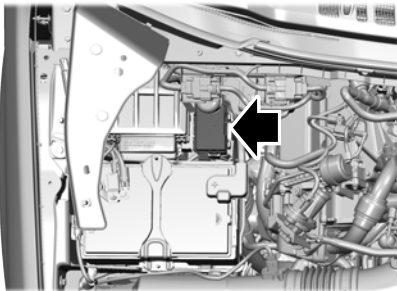

IDENTIFYING THE AUXILIARY SWITCH WIRING

Connection information for auxiliary switch wiring:

Power Distribution Box	Wire Color	Wire Size	Fuse
AUX 1	Brown/ Green	2.0 mm ²	25A
AUX 2	Violet/ Orange	2.0 mm ²	25A
AUX 3	Blue/ Green	2.0 mm ²	25A
AUX 4	Gray/ Brown	2.0 mm ²	25A
AUX 5	Brown/ Yellow	4.0 mm ²	40A
AUX 6	Gray/ Orange	4.0 mm ²	40A

Ford Protect

WHAT IS FORD PROTECT

Ford Protect vehicle service contracts are the only service contracts 100% backed by Ford Motor Company. Protect yourself from unforeseen covered repairs with a Ford Protect extended service plan.

Ford Protect Extended Service Plans - United States Only

You can drive on with confidence as Ford Protect extended service plans provide more protection beyond the New Vehicle Limited Warranty. When you visit your Ford Dealer, insist on a Ford Protect extended service plan.

Ford Protect Can Quickly Pay for Itself

One repair bill can easily exceed the price of your Ford Protect extended service plan. With the Ford Protect extended service plan, you have peace of mind from unforeseen covered repairs.

Up to 1,000+ Covered Vehicle Components

There are four mechanical Ford Protect extended service plans with different levels of coverage to fit your individual needs. Ask your Ford dealer for details.

1. PremiumCARE - Our most comprehensive coverage. With over 1,000 covered components, this plan is so complete it is probably easier to list what is not covered.
2. ExtraCARE - Covers 113 components, and includes many high-tech items.
3. BaseCARE - Covers 84 components.
4. PowertrainCARE - Covers 29 critical components.

Ford Protect extended service plans are honored by all authorized Ford dealers in the United States, Canada and Mexico.

That means you get:

- Ford-authorized parts used for covered repairs.
- Factory-trained and certified technicians.
- Rental vehicle benefits for up to 10 days for covered repairs.

24-Hour Roadside Assistance

Roadside assistance includes:

- Tire change, lockout, out-of-fuel and battery jump-start assistance.
- Towing Assistance.
- Emergency Travel Expense.
- Destination Assistance.

Transferable Coverage

If you sell your vehicle before your Ford Protect extended service plan coverage expires, you can transfer any remaining coverage to the new owner.

Premium Maintenance Plan

It is more than just a routine oil change. Keep your vehicle running at its optimum performance with a Ford Protect Premium Maintenance extended service plan. The coverage is prepaid, so you never have to worry about the future cost of your vehicle's maintenance.

Premium Maintenance covers these important maintenance items:

- Engine oil and filter changes.
- Multi-point inspections.
- Tire rotations.
- Brake pads and linings.
- Shock absorbers and struts.
- Spark plugs.
- Clutch discs-if equipped.

Ford Protect

- Engine belts, coolant hoses and clamps.
- Wiper blades.

This information is subject to change. Visit your local Ford of Canada dealer or www.ford.ca to find the Ford Protect extended service plan that is right for you.

More Information

To learn more about Ford Protect plans and financing options, please contact your selling Ford Dealer.

Ford Protect Extended Service Plan - Canada Only

You can get more protection for your vehicle by purchasing a Ford Protect extended service plan. Ford Protect extended service plan is the only service contract backed by Ford Motor Company of Canada, Limited. Depending on the plan you purchase, Ford Protect extended service plan provides benefits such as:

- Rental reimbursement.
- Coverage for certain maintenance and wear items.
- Protection against repair costs after your New Vehicle Limited Warranty Coverage expires.
- Roadside Assistance benefits.

There are several Ford Protect extended service plans available in various time, distance and deductible combinations. Each plan is tailored to fit your own driving needs, including reimbursement for towing and rental. When you purchase a Ford Protect extended service plan, you receive added peace-of-mind protection throughout Canada, the United States and Mexico, provided by a network of participating authorized Ford Motor Company dealers.

Note: *Repairs performed outside of Canada and the United States are not eligible for Ford Protect extended service plan coverage.*

Scheduled Maintenance

Intelligent Oil-Life Monitor™

Your vehicle has an Intelligent Oil-Life Monitor that determines when you should change the engine oil based on how you use your vehicle. By using several important factors in its calculations, the monitor helps reduce the cost of owning your vehicle and reduces environmental waste at the same time.

This means you do not have to remember to change the oil on a mileage-based schedule. Your vehicle lets you know when an oil change is due by displaying a message in the instrument cluster display.

The following table provides examples of vehicle use and its impact on oil change intervals. It is a guideline only. Actual oil change intervals depend on several factors and generally decrease with severity of use.

Maintenance Intervals

At Every Oil Change Interval as Indicated by the Instrument Cluster Display
Change the engine oil and filter. ¹
Rotate the tires, inspect tire wear and measure the tread depth. ²
Inspect the wheels and related components for abnormal noise, wear, looseness or drag.
Perform multi-point inspection - recommended.
Inspect the brake pads, shoes, rotors, drums, brake linings, hoses and the parking brake.
Refill the diesel exhaust fluid tank.
For diesel vehicles, drain the fuel and water separator if necessary or if indicated by the instrument cluster display.
Inspect the engine coolant concentration, freeze-point protection, level and the hoses. Add coolant additive if necessary.
Inspect the exhaust system and heat shields.
Inspect the front axle and U-joints. If applicable, lubricate the grease fittings. Four-wheel drive vehicles.
Inspect the steering linkage, ball joints, suspension, tie-rod ends, driveshaft and the U-joints. If applicable, lubricate the grease fittings.
Inspect cabin air filter if equipped, service as required.
Inspect engine air filter, service as required.

¹ Reset the Intelligent Oil-Life Monitor after engine oil and filter changes.

² Rotate the front wheels on vehicles with dual rear wheels when specified. Only rotate the rear wheels if you notice unusual wear.

Scheduled Maintenance

Brake Fluid Maintenance¹	
Every three years.	Change the brake fluid. ²

¹ Perform this maintenance item every three years. Do not exceed the designated time for the interval.

² Brake fluid servicing requires special equipment available at your authorized dealer.

Other Maintenance Items	
Every 24,140 km (15,000 mi)	For diesel severe service, replace the engine-mounted and frame-mounted fuel filters.
Every 32,180 km (20,000 mi)	Replace the cabin air filter.
Every 48,000 km (30,000 mi)	Replace the engine air filter. ³
	For diesel vehicles, replace the engine-mounted and frame-mounted fuel filters.
	For severe service, replace the wheel bearing grease and grease seals if using non-sealed bearings (Two-wheel drive vehicles).
	For diesel severe service, replace the air inlet foam filter.
Every 80,467 km (50,000 mi)	For diesel vehicles, replace the engine air inlet foam filter.
	For diesel severe service, change the rear axle fluid (Dana rear axles only - some F-350s; all F-450s and F-550s).
	For diesel severe service, change the transfer case fluid (Four-wheel drive vehicles).
	For diesel severe service, inspect the front axle fluid (Four-wheel drive vehicles).
Every 96,000 km (60,000 mi)	Replace the front wheel bearing grease and grease seal, if you use non-sealed bearings.
	For severe service, change transfer case fluid (Four-wheel drive vehicles).
	For gas vehicle severe service, replace spark plugs.
Every 144,841 km (90,000 mi)	For diesel vehicles, inspect the accessory drive belt(s). ¹

Scheduled Maintenance

Other Maintenance Items	
Every 160,934 km (100,000 mi)	Replace the spark plugs.
	For gas vehicles, inspect the accessory drive belt(s). ¹
	For diesel vehicles, replace the accessory drive belt(s).
Every 240,000 km (150,000 mi)	Change the automatic transmission fluid and filter. Consult dealer for requirements.
	For gas vehicles, replace the accessory drive belt(s).
	Replace the front wheel bearings and seals if you use non-sealed bearings.
	Change the axle(s) fluid. See exceptions.
	Change the transfer case fluid, if applicable.
At 320,000 km (200,000 mi)	Change the engine coolant. ²

¹If not replaced, inspect the accessory drive belt(s) every 24,000 km (15,000 mi).

²Initial replacement at 10 years or 200,000 mi (320,000 km), then every 5 years or 100,000 mi (160,000 km).

³For diesel vehicles, reset the engine air filter information monitor after you replace the air filter.

Exceptions

Axle and Transfer Case Maintenance

Axle(s) and transfer case (4X4 only) fluid changes or level checks are not required unless a leak is suspected or the assembly has been submerged in water. During long periods of trailer towing with outside temperatures above 21°C (70°F) or at wide-open throttle for long periods above 72 km/h (45 mph), change the rear axle fluid every 48,000 km (30,000 mi) if the rear axle is filled with non-synthetic fluid. This interval can be waived and the 240,000 km (150,000 mi) service interval can continue if the rear axle is filled with 75W140 synthetic gear fluid meeting Ford

specification WSL-M2C192-A, part number XY-75W140-QL, or equivalent. Add friction modifier XL-3 (EST-M2C118-A) or equivalent for a complete refill of Traction-Lok rear axles. See **Rear Axle** (page 242).

Additional Axle Maintenance for Dual Rear Wheels

Change rear axle fluid every 400,000 km (250,000 mi) under normal driving conditions on all commercial applications. When operating your vehicle at or near maximum gross vehicle weights, change the rear axle fluid every 96,000 km (60,000 mi). In addition, follow this 96,000 km (60,000 mi) schedule when operating your vehicle under the special operating conditions where noted.

Scheduled Maintenance

California Fuel Filter Replacement

If you register your vehicle in California, the California Air Resources Board has determined that the failure to perform this maintenance item does not nullify the emission warranty or limit recall liability before the completion of your vehicle's useful life. Ford Motor Company, however, urges you to have all recommended maintenance services performed at the specified intervals and to record all vehicle service.

Hot Climate Oil Change Intervals

Vehicles operating in the Middle East, North Africa, Sub-Saharan Africa or locations with similar climates use an American Petroleum Institute (API) Certified for Gasoline Engines (Certification mark) oil of SM or SN quality.

Engine Air Filter and Cabin Air Filter Replacement

The life of the engine air filter and cabin air filter is dependent on exposure to dusty and dirty conditions. Vehicles operated in these conditions require frequent inspection and replacement of the engine air filter and cabin air filter.

Diesel Particulate Filter

Over time, a slight amount of ash builds up in the diesel particulate filter, which is not removed during the regeneration process. The filter may need to be replaced with a new or remanufactured part at approximately 400,000 km (250,000 mi). Actual mileage varies depending on engine and vehicle operating conditions.

In this case, If there are any issues with the oxidation catalyst or particulate filter system, the engine control system sets a service light (wrench icon) to inform you to bring your vehicle to the dealer for service.

What Are Considered Severe Driving Conditions

A vehicle that is driven for short trips of less than 8–16 km (5–10 mi) miles, driving in temperatures greatly below or above average, driving in any dusty conditions, idling more than recommended such as in traffic, and driving with a heavy load or while towing a load are considered severe driving conditions. If the vehicle is driven in any of these conditions, follow the severe service maintenance items listed in the scheduled maintenance chart.

GENERAL MAINTENANCE INFORMATION

Why Maintain Your Vehicle?

Carefully following the maintenance schedule helps protect against major repair expenses resulting from neglect or inadequate maintenance and may help to increase the value of your vehicle when you sell or trade it. Keep all receipts for completed maintenance with your vehicle.

It is important that you have your vehicle serviced at the proper times. These intervals serve two purposes: first is to maintain the reliability of your vehicle and the second is to keep the cost of owning your vehicle down.

It is your responsibility to have all scheduled maintenance performed and to make sure that the materials used meet the specifications identified in this owner's manual. See **Front Axle** (page 240).

Failure to perform scheduled maintenance and regularly inspect your vehicle may result in vehicle damage not covered by the vehicle Warranty.

Scheduled Maintenance

Why Maintain Your Vehicle at Your Dealership?

Our Genuine Replacement Parts

Dealerships stock our parts and our authorized branded remanufactured replacement parts. These parts meet or exceed our specifications. Parts installed at your dealership carry a nationwide 24-month or unlimited mile (kilometer) parts and labor limited warranty.

If you do not use our authorized parts, they may not meet our specifications and could affect emissions compliance.

Protecting Your Investment

Maintenance is an investment that pays dividends in the form of improved reliability, durability and resale value. To maintain the proper performance of your vehicle and its emission control systems, make sure you have scheduled maintenance performed at the designated intervals.

Your vehicle comes with the Intelligent Oil-Life Monitor system, a message appears in the instrument cluster display at the proper oil change interval.

When the oil change message appears in the instrument cluster display, it is time for an oil change. Make sure you perform the oil change within two weeks or 800 km (500 mi) of the message appearing. Make sure to reset the Intelligent Oil-Life Monitor after each oil change. See **Resetting the Intelligent Oil Life Monitor** (page 450).

If your information display resets prematurely or becomes inoperative, you should never exceed one year or 24,000 km (15,000 mi) for diesel vehicles and 16,000 km (10,000 mi) for gas vehicles between oil change intervals.

You can drive vehicles in such a way that may lead to higher oil consumption including extended time at high engine speeds, high loads, engine braking, hard cornering maneuvers, track and off-road usage. Under these conditions, oil consumption of approximately 1 quart per 500 miles (1 liter per 800 km) is possible. Check the engine oil level at every refueling and adjust to maintain proper levels to avoid engine damage.

You can also drive your vehicle in such a way that dilutes and increases the level of oil by frequent short trips that do not allow the engine to get to operating temperature, extended idling and low speed driving for long periods of time.

It is important to rely upon your dealership to properly diagnose and repair your vehicle.

We strongly recommend only using our genuine or our authorized re-manufactured replacement parts engineered for your vehicle.

Additives and Chemicals

We do not recommend using chemicals or additives not approved by us as part of your vehicle's normal maintenance. Please consult your warranty information.

Oils, Fluids and Flushing

In many cases, fluid discoloration is a normal operating characteristic and, by itself, does not necessarily indicate a concern or that you need to have the fluid changed. Have discolored fluids that also show signs of overheating or foreign material contamination immediately checked.

Scheduled Maintenance

Make sure to change the vehicle's oils and fluids at the specified intervals or in conjunction with a repair. Flushing is a viable way to change fluid for many vehicle sub-systems during scheduled maintenance. It is critical that systems are flushed only with new fluid that is the same as that required to fill and operate the system or using our approved flushing chemical.

Scheduled Maintenance Service Intervals

For your scheduled maintenance service intervals, visit <https://www.ford.com/support/maintenance-schedule>.

Owner Checks and Services

Make sure you perform the following basic maintenance checks and inspections.

Check Every Month
The air filter restriction gauge. ¹
The engine oil level.
Function of all interior and the exterior lights.
The tires including the spare for wear and proper pressure.
The windshield washer fluid level.
The fuel and water separator. Drain if necessary or if indicated by the information display. ¹
The holes and slots in the tail pipe to make sure they are functional and clear of debris. ¹

¹Diesel vehicles only.

Check Every Six Months
The battery connections. Clean if necessary.
The body and door drain holes for obstructions. Clean if necessary.
The cooling system fluid level and the coolant system strength.
The door weatherstrips for wear. Lubricate if necessary.
The hinges, latches and outside locks for proper operation. Lubricate if necessary.
The parking brake for proper operation.
The seatbelts and seat latches for wear and function.
Safety warning lamps, brake, ABS, airbag and seatbelt for operation.
The washer spray and wiper operation. Clean or replace blades as necessary.

Scheduled Maintenance

Multi-Point Inspection

It is important to have the systems on your vehicle regularly checked. This can help identify potential issues and prevent major

problems. We recommend having the following multi-point inspection performed at every scheduled maintenance interval to help make sure your vehicle keeps running great.

Multi-Point Inspection	
Accessory drive belt or belts	Hazard warning system operation
Battery performance	Horn operation
Engine air filter	Radiator, cooler, heater and air conditioning hoses
Exhaust system	Suspension components for leaks or damage
Exterior lamps operation	Steering and linkage
Fluid levels ¹ ; fill if necessary	Tires including the spare for wear and proper pressure ²
For oil and fluid leaks	Windshield for cracks, chips or pits
Halfshaft dust boots	Washer spray and wiper operation

¹ Brake, coolant recovery reservoir, automatic transmission and window washer.

² If your vehicle has a temporary mobility kit, check the tire sealant expiration Use By date on the canister. Replace as needed.

Make sure to ask your dealership service advisor or technician about the multi-point vehicle inspection. It is a comprehensive way to perform a thorough inspection of your vehicle. Your checklist gives you immediate feedback on the overall condition of your vehicle.

Severe Driving Conditions

A vehicle that is driven for short trips of less than 8–16 km (5–10 mi) miles, driving in temperatures greatly below or above average, driving in any dusty conditions, idling more than recommended such as in traffic, and driving with a heavy load or while towing a load are considered severe driving conditions. If you drive your vehicle in any of these conditions, follow the severe service maintenance items listed in the scheduled maintenance chart.

Scheduled Maintenance

Axle and Transfer Case Maintenance

Axle(s) and transfer case (4X4 only) fluid changes or level checks are not required unless you suspect a leak or the assembly has been submerged in water. During long periods of trailer towing with outside temperatures above 21°C (70°F) or at wide-open throttle for long periods above 72 km/h (45 mph), change the rear axle fluid every 48,000 km (30,000 mi) if the rear axle is filled with non-synthetic fluid. This interval can be waived and the 240,000 km (150,000 mi) service interval can continue if the rear axle is filled with 75W140 synthetic gear fluid meeting Ford specification WSL-M2C192-A, part number XY-75W140-QL, or equivalent. Add friction modifier XL-3 (EST-M2C118-A) or equivalent for a complete refill of Traction-Lok rear axles. See **Front Axle** (page 240).

Additional Axle Maintenance for Dual Rear Wheels

Change rear axle fluid every 400,000 km (250,000 mi) under normal driving conditions on all commercial applications. When operating your vehicle at or near maximum gross vehicle weights, change the rear axle fluid every 96,000 km (60,000 mi). In addition, follow this 96,000 km (60,000 mi) schedule when operating your vehicle under the special operating conditions where noted.

California Fuel Filter Replacement

If you register your vehicle in California, the California Air Resources Board has determined that the failure to perform this maintenance item does not nullify the emission warranty or limit recall liability before the completion of your vehicle's useful life. Ford Motor Company, however, urges you to have all recommended maintenance services performed at the specified intervals and to record all vehicle service.

Hot Climate Oil Change Intervals

Vehicles operating in the Middle East, North Africa, Sub-Saharan Africa or locations with similar climates use an American Petroleum Institute (API) Certified for Gasoline Engines (Certification mark) oil of SM or SN quality.

Engine Air Filter and Cabin Air Filter Replacement

The life of the engine air filter and cabin air filter is dependent on exposure to dusty and dirty conditions. Vehicles operated in these conditions require frequent inspection and replacement of the engine air filter and cabin air filter.

Diesel Particulate Filter

Over time, a slight amount of ash builds up in the diesel particulate filter, which is not removed during the regeneration process. The filter may need to be replaced with a new or remanufactured part at approximately 400,000 km (250,000 mi). Actual mileage varies depending on engine and vehicle operating conditions.

In this case, the engine control system sets a service light (wrench icon) to inform you to bring your vehicle to the dealer for service. If there are any issues with the oxidation catalyst or particulate filter system, a service light (wrench or engine icon) sets by the engine control system to inform you to bring your vehicle into a dealer for service.

Customer Information

ROLLOVER WARNING



WARNING: Utility vehicles have a significantly higher rollover rate than other types of vehicles.



WARNING: Vehicles with a higher center of gravity (utility and four-wheel drive vehicles) handle differently than vehicles with a lower center of gravity (passenger cars). Avoid sharp turns, excessive speed and abrupt steering in these vehicles. Failure to drive cautiously increases the risk of losing control of your vehicle, vehicle rollover, personal injury and death.



WARNING: In a rollover crash, an unbelted person is significantly more likely to die than a person wearing a seatbelt.



WARNING: Do not become overconfident in the ability of four-wheel drive vehicles. Although a four-wheel drive vehicle may accelerate better than a two-wheel drive vehicle in low traction situations, it won't stop any faster than two-wheel drive vehicles. Always drive at a safe speed.

Utility vehicles and trucks handle differently than passenger cars in the various driving conditions that are encountered on streets, highways and off-road. Utility vehicles and trucks are not designed for cornering at speeds as high as passenger cars any more than low-slung sports cars are designed to perform satisfactorily under off-road conditions.

THE BETTER BUSINESS BUREAU AUTO LINE PROGRAM

Your satisfaction is important to Ford Motor Company and to your dealer. If a warranty concern has not been resolved using the three-step procedure outlined earlier in this chapter in the Getting the Services you need section, you may be eligible to participate in the BBB AUTO LINE program.

The BBB AUTO LINE program consists of two parts – mediation and arbitration. During mediation, a representative of the BBB will contact both you and Ford Motor Company to explore options for settlement of the claim. If an agreement is not reached during mediation or you do not want to participate in mediation, and if your claim is eligible, you may participate in the arbitration process. An arbitration hearing will be scheduled so that you can present your case in an informal setting before an impartial person. The arbitrator considers the testimony provided and makes a decision after the hearing.

Disputes submitted to the BBB AUTO LINE program are usually decided within 40 days after you file your claim with the BBB. You are not bound by the decision, and may reject the decision and proceed to court where all findings of the BBB Auto Line dispute, and decision, are admissible in the court action. Should you choose to accept the BBB AUTO LINE decision, Ford is then bound by the decision, and must comply with the decision within 30 days of receipt of your acceptance letter.

BBB AUTO LINE Application: Using the information that follows, call or write to request a program application. You will be asked for your name and address, general information about your new vehicle, information about your warranty concerns, and any steps you have already taken to

Customer Information

try to resolve them. A Customer Claim Form will be mailed that needs to be completed, signed and returned to the BBB along with proof of ownership. Upon receipt, the BBB reviews the claim for eligibility under the Program Summary Guidelines.

You can get more information by calling BBB AUTO LINE at 1-800-955-5100, or writing to:

**BBB AUTO LINE a Division of BBB National Programs, Inc.
1676 International Drive, Suite 550
McLean, VA 22102**

BBB AUTO LINE applications can also be requested by calling the Ford Motor Company Customer Relationship Center at 1-800-392-3673.

For additional information, refer to the Better Business Bureau website.

Note: *Ford Motor Company reserves the right to change eligibility limitations, modify procedures, or to discontinue this process at any time without notice and without obligation.*

THE MEDIATION AND ARBITRATION PROGRAM

For vehicles delivered to authorized Canadian dealers. In those cases where you continue to feel that the efforts by Ford of Canada and the authorized dealer to resolve a factory-related vehicle service concern have been unsatisfactory, Ford of Canada participates in an impartial third party mediation/arbitration program administered by the Canadian Motor Vehicle Arbitration Plan (CAMVAP).

The CAMVAP program is a straightforward and relatively speedy alternative to resolve a disagreement when all other efforts to produce a settlement have failed. This procedure is without cost to you and is designed to eliminate the need for lengthy and expensive legal proceedings.

In the CAMVAP program, impartial third-party arbitrators conduct hearings at mutually convenient times and places in an informal environment. These impartial arbitrators review the positions of the parties, make decisions and, when appropriate, render awards to resolve disputes. CAMVAP decisions are fast, fair, and final as the arbitrator's award is binding on both you and Ford of Canada.

CAMVAP services are available in all Canadian territories and provinces. For more information, without charge or obligation, call your CAMVAP Provincial Administrator directly at 1-800-207-0685 or visit www.camvap.ca.

REPORTING SAFETY DEFECTS IN THE UNITED STATES

If you believe that your vehicle has a defect which could cause a crash or could cause injury or death, you should immediately inform the National Highway Traffic Safety Administration (NHTSA) in addition to notifying Ford Motor Company.

Customer Information

If NHTSA receives similar complaints, it may open an investigation, and if it finds that a safety defect exists in a group of vehicles, it may order a recall and remedy campaign. However, NHTSA cannot become involved in individual problems between you, your dealer, or Ford Motor Company.

To contact NHTSA, you may call the Vehicle Safety Hotline toll-free at 1-888-327-4236 (TTY: 1-800-424-9153); go to www.safercar.gov; or write to:

Administrator

1200 New Jersey Avenue,
Southeast

Washington, D.C. 20590

You can also obtain other information about motor vehicle safety from www.safercar.gov.

REPORTING SAFETY DEFECTS IN CANADA

If you believe that your vehicle has a defect which could cause a crash or could cause injury or death, you should immediately inform Transport Canada and Ford of Canada.

Transport Canada Contact Information	
Website (English)	http://tc.canada.ca/recalls
Website (French)	http://tc.canada.ca/rappels
Phone	1-800-333-0510

Ford of Canada Contact Information	
Website	www.ford.ca
Phone	1-800-565-3673

Customer Information

THIRD PARTY SOFTWARE COPYRIGHT ACKNOWLEDGMENT

Your vehicle could have components that use open source software. For additional information, visit <http://corporate.ford.com/ford-open-source.html>.

RADIO FREQUENCY CERTIFICATION LABELS

BLIND SPOT INFORMATION SYSTEM SENSORS

Device	Supplier	Type Designation
SRR5 BLIS Corner Radar (RRU2)	Aptiv	2F5TR

Argentina

15375-23-12270



China

CMIIT ID: 2023LJ10407

Djibouti

AGREE PAR LE MCPT (REPUBLIQUE DE DJIBOUTI)

Numéro d'agrément:

040/DDTIC/2024

Date d'agrément:

16/04/2024

H-28070

Brazil



Customer Information

Europe Union EU

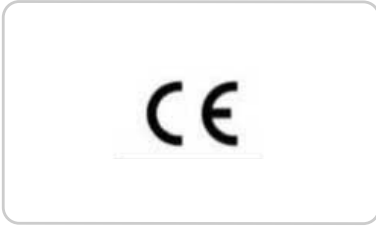

Mexico

IFT: ROAP2F23-27117

Morocco

AGREE PAR L'ANRT MAROC

Numéro d'agrément:

MR00036523ANRT2023

Date d'agrément:

30/01/23

Ghana

NCA APPROVED: 7E6-M0-XDF-TME

Indonesia

Sertifikat Nomor: 98785/SDPPI/2024
PLG ID: 13493



Paraguay



NR: 2022-04-I-0255

Jamaica

This product has been Type Approved by
Jamaica: SMA - 2F5TR.

South Africa

Mauritania

AGREE PAR L'ANE MAURITANIE

Numéro d'agrément:

1222/ARE/2023

Date d'agrément:

06/02/2023



Customer Information

South Korea



R-C-1Ap-2F5TR

Taiwan



CCA123LP0640T2

United Arab Emirates (U.A.E.)

The logo for TDR (Telecommunications Regulatory Authority) is the letters 'TDR' in blue with a gold triangle above the 'A', underlined.

ER10085/22
United Arab Emirates



United Kingdom



United States and Canada

FCC ID: L2C2F5TR

IC: 3432A-2F5TR

Customer Information

This equipment generates, uses, and can radiate radio frequency energy and may cause harmful interference to radio communications. There is no guarantee that interference will not occur in a particular installation. If this equipment does cause harmful interference to radio or television reception, please consult the dealer.

This product is not end-user serviceable.

RF Radiation Exposure Statement: This equipment complies with FCC RF Radiation exposure limits set forth for an uncontrolled environment. This device and its antenna must not be co-located or operating in conjunction with any other antenna or transmitter. This equipment should be installed and operated with a minimum distance of 20cm between the radiator and your body.

This device complies with Part 15 of the FCC Rules and with Innovation, Science and Economic Development Canada's licence-exempt RSS(s). Operation is subject to the following two conditions:

1. This device may not cause harmful interference, and
2. This device must accept any interference received, including interference that may cause undesired operation.

Le présent appareil est conforme aux CNR d'Industrie Canada applicables aux appareils radio exempts de licence. L'exploitation est autorisée aux deux conditions suivantes:

- 1. L'appareil ne doit pas produire de brouillage;*
- 2. L'appareil doit accepter tout brouillage radioélectrique subi, même si le brouillage est susceptible d'en compromettre le fonctionnement.*

BLIND SPOT INFORMATION SYSTEM SENSORS

Device	Supplier	Type Designation
SRR5 BLIS Corner Radar	Aptiv	F5TR

Argentina



Brazil



Customer Information

China

CMIIT ID: 2022LP14250

Djibouti

AGREE PAR LE MCPT (REPUBLIQUE DE DJIBOUTI)
Numéro d'agrément : 195/MCPT/DDTIC
Date d'agrément : 06/09/2021

Europe Union EU

CE

Ghana

NCA APPROVED: SRO-1M-7E4-X0E

Indonesia

Sertifikat Nomor: 90715/SDPPI/2023
PLG ID: 13493



Jamaica

This product has been Type Approved by Jamaica: SMA – F5TR.

Customer Information

Mauritania

AGREE PAR L'ANEMAURITANIE
Numéro d'agrément : 0985/ARE/2021
Date d'agrément : 24/08/2021

Paraguay



NR: 2020-10-I-0753

Mexico

IFETEL: RCPAPF520-0480

Singapore

Morocco

AGREE PAR L'ANRT MAROC
Nu méro d'agrément : MR00030033ANRT2021
Date d'agrément : 16/09/2021

Complies with IMDA Standards

DA 00461

South Africa



Customer Information

South Korea



Thailand

- (1) ชื่อบริษัทและรูปแบบนี้ มีความสอดคล้องพจนานุกรมของ กทข.
- (2) ชื่อวีดิทัศน์และวีดิทัศน์การเคลื่อนย้ายสินค้าเพื่อส่งมอบตามความสามารถของข้อมูลภาพของระบบซึ่งทำการใช้ชื่อวีดิทัศน์และรูปแบบการปฏิบัติงานที่สอดคล้องกับข้อกำหนด

Taiwan



Ukraine



United Arab Emirates (U.A.E.)



Customer Information

United Kingdom



This device complies with Part 15 of the FCC Rules and with Innovation, Science and Economic Development Canada's licence-exempt RSS(s). Operation is subject to the following two conditions:

1. This device may not cause harmful interference, and
2. This device must accept any interference received, including interference that may cause undesired operation.

L'émetteur/récepteur exempt de licence contenu dans le présent appareil est conforme aux CNR d'Innovation, Sciences et Développement économique Canada applicables aux appareils radio exempts de licence. L'exploitation est autorisée aux deux conditions suivantes:

1. L'appareil ne doit pas produire de brouillage;
2. L'appareil doit accepter tout brouillage radioélectrique subi, même si le brouillage est susceptible d'en compromettre le fonctionnement.

Note: Changes or modifications not expressly approved by the party responsible for compliance could void the user's authority to operate the equipment.

Nota: Tout changement apporté au dispositif sans l'approbation expresse des autorités compétentes pourrait révoquer le droit de l'utilisateur d'en faire usage.

Vietnam



Customer Information

BODY CONTROL MODULE

Device	Supplier	Type Designation
BCM GEN3	Continental	M3NA2C780107

Argentina



H-29805

Brazil



Este equipamento não tem direito à proteção contra interferência prejudicial e não pode causar interferência em sistemas devidamente autorizados.

19120-23-16195

European Union EU

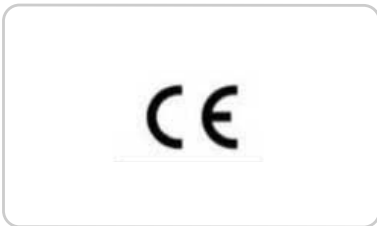

Jamaica

This product has been Type Approved by Jamaica: M3NA2C780107

Israel

1. מספר אישור התאמה מטעם משרד התקשורת: 5I-87448
2. חל אישור לבצע עיבודים כספרי ישו בלבד לצמח את כוונותיו האלחוטיות של המכשיר, ובכלל זה שינוי תכונה, החלפת אנטנה סקריות או הספת אפשרות לייבו לראשונה ייצוגית, בלא קבלת אישור משרד התקשורת, בשל החשש להפרעת אלחוטיות.

Malaysia



HIDF16000009

Customer Information

Mexico



IFT: ROCOM323-07072

Moldova



Morocco

AGREE PAR L'ANRT MAROC

Numéro d'agrément:
MR00034975ANRT2022

Date d'agrément: 21/10/2022

Paraguay



NR: 2023-08-I-0556

Serbia



Singapore

Complies with IMDA Standards

DA 00461

Customer Information

South Africa



Taiwan



CCAB22LP1250T4
CCAB22LP1260T7

Thailand



เครื่องวิทยุคมนาคมนี้ ได้รับยกเว้น ไม่ต้องได้รับใบอนุญาตให้มี ใช้ซึ่งเครื่องวิทยุคมนาคมหรือตั้งสถานีวิทยุคมนาคมตามประกาศ กสทช. เรื่อง เครื่องวิทยุคมนาคม และสถานีวิทยุคมนาคมที่ได้รับยกเว้นไม่ต้องได้รับใบอนุญาตวิทยุคมนาคม ตามพระราชบัญญัติวิทยุคมนาคม พ.ศ. 2498



nabp. โทรคมนาคม
กำกับดูแลเพื่อประชาชน
Call Center 1200 (InSW)

The image is a rectangular box containing information for Thailand. At the top is the logo for nabp (National Administrative Office of Broadcasting and Telecommunications), which features a red bird-like emblem above the text 'nabp.'. Below the logo is a paragraph of Thai text explaining that the radio equipment is exempt from license requirements. To the left of the bottom text is a QR code. To the right is the nabp. logo and contact information: 'โทรคมนาคม กำกับดูแลเพื่อประชาชน Call Center 1200 (InSW)'.

Ukraine



Customer Information

United Arab Emirates (U.A.E.)

TDRA

ER12810/22
United Arab Emirates



United Kingdom

**UK
CA**

United States and Canada

FCC ID: M3NA2C780107

IC: 7812A-A2C780107

This device complies with Part 15 of the FCC Rules and with Innovation, Science and Economic Development Canada's licence-exempt RSS(s). Operation is subject to the following two conditions:

1. This device may not cause harmful interference, and
2. This device must accept any interference received, including interference that may cause undesired operation.

L'émetteur/récepteur exempt de licence contenu dans le présent appareil est conforme aux CNR d'Innovation, Sciences et Développement économique Canada applicables aux appareils radio exempts de licence. L'exploitation est autorisée aux deux conditions suivantes:

1. L'appareil ne doit pas produire de brouillage;
2. L'appareil doit accepter tout brouillage radioélectrique subi, même si le brouillage est susceptible d'en compromettre le fonctionnement.

Note: Changes or modifications not expressly approved by the party responsible for compliance could void the user's authority to operate the equipment.

Nota: Tout changement apporté au dispositif sans l'approbation expresse des autorités compétentes pourrait révoquer le droit de l'utilisateur d'en faire usage.

Customer Information

CRUISE CONTROL MODULE

Device	Supplier	Type Designation
MRR3 Medium Range Radar	Aptiv	F3TR

Argentina



Djibouti

AGREE PAR LE MCPT (REPUBLIQUE DE DJIBOUTI)
Numéro d'agrément : 059/DDTIC/2020
Date d'agrément : 01/10/2020

Brazil



EAC Marking - Russia, Belarus, Kazakhstan



Europe Union EU

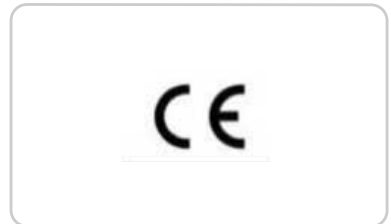

Customer Information

Ghana

NCA APPROVED: SRO-1M-7E4-X13

Israel

1. מספר אישור התאמת מטעם משרד התקשורת: 51-95979
2. תל איסור לבצע פעולות במכשיר שיש בו כדי לפגוע את חבונותי האלחוטיות של המכשיר, וכלל זה שנייה תוכנה, החלפת אנטנה מקרית או הוספת אפשרות לחיבור לאנטנה חיצונית, בלא קבלת אישור משרד התקשורת, בשל החשש להפרעות אלחוטיות.

Jamaica

This product has been Type Approved by Jamaica: SMA – F3TR.

Independent State Of Samoa



Malaysia



HIDF16000009

Indonesia

Sertifikat Nomor: 90714/SDPPI/2023
PLG ID: 13493



Customer Information

Mauritania

AGREE PAR L'ANE MAURITANIE
Numéro d'agrément : 0835/ARE/2020
Date d'agrément : 31/08/2020

Pakistan



Mexico

IFT: RCPAPF320-0479

Moldova



Paraguay



Morocco

AGREE PAR L'ANRT MAROC

Numéro d'agrément:
MR00030034ANRT2021

Date d'agrément: 16/09/2021

Customer Information

South Africa

NR: 2020-10-I-0752

Sierra Leone



South Korea

TAN: 2021-002-0028

Singapore

Complies with IMDA Standards

DA 00461



R-C-1Ap-F3TR

Taiwan



Customer Information

Thailand

- (1) เครื่องโทรคมนาคมและอุปกรณ์นี้ มีความสอดคล้องตามข้อกำหนดของ กทท.
- (2) เครื่องโทรคมนาคมและอุปกรณ์นี้ได้รับการแก้ไขข้อบกพร่องที่สอดคล้องตามมาตรฐานความปลอดภัยของอุตสาหกรรมอย่างถูกต้องแล้ว เครื่องโทรคมนาคมและอุปกรณ์นี้ได้รับการแก้ไขที่โรงงานผลิตของบริษัทผู้ผลิต

Ukraine



Unites Arab Emirates (U.A.E.)

TDR[^]

ER19344/23
United Arab Emirates



United Kingdom



United States and Canada

FCC ID: L2CF3TR
IC: 3432A-F3TR

Customer Information

This device complies with Part 15 of the FCC Rules and with Innovation, Science and Economic Development Canada's licence-exempt RSS(s). Operation is subject to the following two conditions:

1. This device may not cause harmful interference, and
2. This device must accept any interference received, including interference that may cause undesired operation.

L'émetteur/récepteur exempt de licence contenu dans le présent appareil est conforme aux CNR d'Innovation, Sciences et Développement économique Canada applicables aux appareils radio exempts de licence. L'exploitation est autorisée aux deux conditions suivantes:

1. L'appareil ne doit pas produire de brouillage;
2. L'appareil doit accepter tout brouillage radioélectrique subi, même si le brouillage est susceptible d'en compromettre le fonctionnement.

Note: Changes or modifications not expressly approved by the party responsible for compliance could void the user's authority to operate the equipment.

Nota: Tout changement apporté au dispositif sans l'approbation expresse des autorités compétentes pourrait révoquer le droit de l'utilisateur d'en faire usage.

Zambia



INTEGRATED KEYHEAD TRANSMITTER

Device	Supplier	Type Designation
Integrated Keyhead Transmitter (IKT)	Valeo	A08TBB

Customer Information

Argentina



H-13305



Indonesia

Sertifikat Nomor: 90413/SDPPI/2023
PLG ID: 13493



Israel

1. מספר אישור התאמה מסעם משרד התקשורת: 51-96885
2. חל אישור לכצע פעולות במסגרת שיש בהן כדי לשנות את תכונותיו האלקטרוניות של המכשיר, ובכלל זה שינוי תוכנה, החלפת אנטנה מקינרת או הוספת אפשרות להרכיב לראשונה חיצונית, בלא קבלת אישור משרד התקשורת, כשל החשש להפרעת אלקטרוניות.

Malaysia



Democratic Republic of Congo

Agréé par l'ARPTC

N° d'homologation: HIR - 00135/2014

Date d'homologation: 29/01/2015

Djibouti

AGREE PAR LE MCPT (REPUBLIQUE DE DJIBOUTI)

Numéro d'agrément:

127/DDTIC/2021

Date d'agrément:

07/09/2021

Customer Information

HIDF16000009

Mauritania

AGREE PAR L'ANE MAURITANIE

Numéro d'agrément: 0858/ARE/2020

Date d'agrément: 02/11/2020

Mexico



IFT: RLVVAA017-0749

Moldova



Morocco

AGREE PAR L'ANRT MAROC

Numéro d'agrément:

MR 00041096 ANRT 2023

Date d'agrément:

25/12/2023

Pakistan



Paraguay



Customer Information

NR: 2017-10-I-0334

NR: 2022-60-I-0397

Serbia



South Africa



E272859

United Arab Emirates (U.A.E)



Taiwan



Thailand

- (1) คือชื่อหน่วยงานและอุปกรณ์นี้ มีความสอดคล้องพจนานุกรมของ กทท.
- (2) คือชื่อวิทยุคมนาคมหรือระดับการเดินคลื่นแม่เหล็กไฟฟ้าที่สอดคล้องพจนานุกรมตามใบอนุญาตของกรมอุตุนิยมวิทยาหรือชื่อวิทยุคมนาคมที่คณะกรรมการกิจการโทรคมนาคมแห่งชาติประกาศ

Ukraine



Customer Information

Vietnam

Zambia



E272868

INTEGRATED KEYHEAD TRANSMITTER

Device	Supplier	Type Designation
Integrated Keyhead Transmitter (IKT)	Valeo	A08TBLP

IC: 3248A-A08TBLP

Jamaica

This product has been Type Approved by Jamaica: N5F – A08TBLP.

United States and Canada

FCC ID: N5F-A08TBLP

Customer Information

This device complies with Part 15 of the FCC Rules and with Innovation, Science and Economic Development Canada's licence-exempt RSS(s). Operation is subject to the following two conditions:

1. This device may not cause harmful interference, and
2. This device must accept any interference received, including interference that may cause undesired operation.

L'émetteur/récepteur exempt de licence contenu dans le présent appareil est conforme aux CNR d'Innovation, Sciences et Développement économique Canada applicables aux appareils radio exempts de licence. L'exploitation est autorisée aux deux conditions suivantes:

1. L'appareil ne doit pas produire de brouillage;
2. L'appareil doit accepter tout brouillage radioélectrique subi, même si le brouillage est susceptible d'en compromettre le fonctionnement.

Note: Changes or modifications not expressly approved by the party responsible for compliance could void the user's authority to operate the equipment.

Nota: Tout changement apporté au dispositif sans l'approbation expresse des autorités compétentes pourrait révoquer le droit de l'utilisateur d'en faire usage.

PASSIVE ANTI-THEFT SYSTEM

Device	Supplier	Type Designation
ITM	Omron/Nidec	OUC11545917

Argentina



Brazil



Customer Information

0106-14-03199

Ghana

NCA APPROVED: NCA/TA/16/22

Canada and United States of America



WARNING: Changes or modifications not expressly approved by the party responsible for compliance could void the user's authority to operate the equipment. The term "IC:" before the radio certification number only signifies that Industry Canada technical specifications were met.

FCC ID: OUC11545917

IC: OUC11545917

This device complies with Part 15 of the FCC Rules and with Innovation, Science and Economic Development Canada's licence-exempt RSS(s). Operation is subject to the following two conditions:

1. This device may not cause harmful interference, and
2. This device must accept any interference received, including interference that may cause undesired operation.

Indonesia

SERTIFIKAT NOMOR : 44714/SDPPI/2016
PLG ID: 4941

Djibouti

AGREE PAR LE MCPT (REPUBLIQUE DE DJIBOUTI)
Numéro d'agrément: 243/MCPT/SC/16
Date d'agrément: 23/05/16

Jamaica

This product has been Type Approved by Jamaica: SMA- OUC11545917

Customer Information

Malaysia



CIDF18000209

Mauritania

AGREE PAR L'ANE MAURITANIE
Numéro d'agrément: 0231/ARE/2014
Date d'agrément: 14/11/2014

Morocco

AGREE PAR L'ANRT MAROC
Numéro d'agrément: MR 8922 ANRT 2014
Date d'agrément: 04/02/2014

Pakistan



Moldova



Paraguay

NR: 2017-09-10000292



Customer Information

Serbia



U011 16

South Korea



MSIP-RRM-OAC-OUC11541917

Syria

SyTRA
REGISTERED No:
1510/4NK

Singapore

Complies with IMDA Standards

DA 00461

South Africa

TA-2013/1617

APPROVED



Taiwan

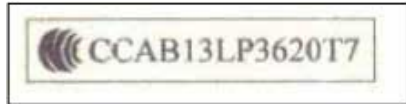

Customer Information

Ukraine



United Arab Emirates (U.A.E.)



Vietnam



Customer Information

PASSIVE KEY

Device	Supplier	Type Designation
Passive Key Transmitter	Continental	A3C108397

Argentina

(RAMATEL Isologotype)



RAMATEL
H-28042

 RAMATEL
H-28042

 RAMATEL H-28042

(RAMATEL Isotype)



H-28042

 H-28042

(RAMATEL Isologotype)



RAMATEL
H-29612

 RAMATEL
H-29612

 RAMATEL H-29612

(RAMATEL Isotype)



H-29612

 H-29612

(RAMATEL Isologotype)



RAMATEL
H-30147

 RAMATEL
H-30147

 RAMATEL H-30417

(RAMATEL Isotype)



H-30147

 H-30147

Customer Information

Brazil



NR: 2022-03-I-0162

Serbia

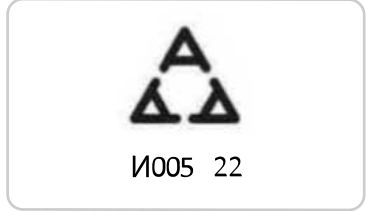

03184-23-06546

Israel

1. מספר אישור התאמת מטעם משרד התקשורת: 51-85634
2. חל אישור לבצע פעולות במכשיר שישי בהן כדי לענות את הכוונתו האלמנטית של המכשיר, ובכלל זה שינויי תכונה, החלפת אנטנה מקורית או הוספת אישורת לחיבור לאנטנה הישנית, בלא קבלת אישור משרד התקשורת, בעל הוויסא לרפורמת אלמנטית.

Singapore

Complies with IMDA Standards

Dealer License Number:

DA 00461

Jamaica

This product has been Type Approved by Jamaica: SMA – M3N-A3C108397

South Africa



Paraguay



Taiwan



CCAB22LP1030T3

Customer Information

Thailand

(1) เครื่องใช้โทรคมนาคมและอุปกรณ์นี้ มีความสอดคล้องตามข้อกำหนดของ กทช.

(2) เครื่องใช้โทรคมนาคมและอุปกรณ์นี้ได้รับการแก้ไขข้อบกพร่องที่พบที่สอดคล้องตามมาตรฐานความปลอดภัยข้อสุดท้ายของกรมอุตุนิยมวิทยาการแจ้ง เพื่อช่วยเหลือคนพิการที่ประสบความยากลำบากในการใช้งานโทรคมนาคมแห่งชาติประเทศไทย

United Arab Emirates (U.A.E.)



United Kingdom



United States and Canada

FCC ID: M3N-A3C108397

IC ID: 7812A-A3C108397

Customer Information

This device complies with Part 15 of the FCC Rules and with Innovation, Science and Economic Development Canada's licence-exempt RSS(s). Operation is subject to the following two conditions:

1. This device may not cause harmful interference, and
2. This device must accept any interference received, including interference that may cause undesired operation.

L'émetteur/récepteur exempt de licence contenu dans le présent appareil est conforme aux CNR d'Innovation, Sciences et Développement économique Canada applicables aux appareils radio exempts de licence. L'exploitation est autorisée aux deux conditions suivantes:

1. L'appareil ne doit pas produire de brouillage;
2. L'appareil doit accepter tout brouillage radioélectrique subi, même si le brouillage est susceptible d'en compromettre le fonctionnement.

Note: Changes or modifications not expressly approved by the party responsible for compliance could void the user's authority to operate the equipment.

Note: Tout changement apporté au dispositif sans l'approbation expresse des autorités compétentes pourrait révoquer le droit de l'utilisateur d'en faire usage.

RADIO TRANSCEIVER MODULE

Device	Supplier	Type Designation
Radio Transceiver Module (RTM)	Aptiv	FO2-RX433UDA

Democratic Republic of Congo

Agréé par l'ARPTC

N° d'homologation:

HER - 0151/Septembre/2022

Date d'homologation:

22/09/2022

Djibouti

AGREE PAR LE MCPT (REPUBLIQUE DE DJIBOUTI)

Numéro d'agrément:

033/DDTIC/2020

Date d'agrément:

07/06/2020

Customer Information

Europe Union EU

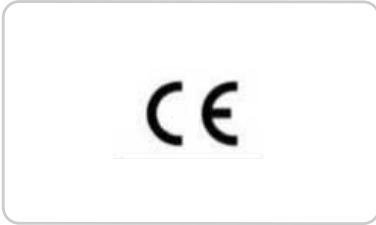

Israel

1. מספר אישור התאמה מטעם משרד התקשורת: 56-03001
2. חל אישור לבצע פעולות במכשיר שיש בהן כדי לשנות את תכונותיו האלחוטיות של המכשיר, ובכלל זה שינוי תוכנה, החלפת אנטנה מקורית או הוספת אפשרות לחיבור לאנטנה חיצונית, כלא קבלת אישור משרד התקשורת, כשל החשש להפרעת אלחוטיות.

Ghana

NCA PRODUCT IDENTIFIERS: SRO-1M-7E4-108

1. מספר אישור התאמה מטעם משרד התקשורת: 56-03001
2. חל אישור לבצע פעולות במכשיר שיש בהן כדי לשנות את תכונותיו האלחוטיות של המכשיר, ובכלל זה שינוי תוכנה, החלפת אנטנה מקורית או הוספת אפשרות לחיבור לאנטנה חיצונית, כלא קבלת אישור משרד התקשורת, כשל החשש להפרעת אלחוטיות.

Jamaica

This product has been Type Approved by Jamaica: SMA – FO2-RX433UDA

Malaysia

Independent State of Samoa



HIDF16000009

Customer Information

Mauritania

AGREE PAR L'ANE MAURITANIE

Numéro d'agrément:

0803/ARE/2020

Date d'agrément:

03/06/2020

Morocco

AGREE PAR L'ANE MAROC
Numéro d'agrément : MR 24102 ANRT 2020
Date d'agrément : 18/05/2020

Mexico



IFT: RCPAPFO21-0004

Pakistan



Moldova



Serbia



Customer Information

South Africa



Ukraine



Taiwan



CCAB22LP1370T1

Thailand

United Kingdom



เครื่องหมายการค้าและสัญลักษณ์นี้ มีความสอดคล้องตามข้อกำหนดของ กทท.

United Arab Emirates (U.A.E.)



Customer Information

Zambia



SYNC

Device	Supplier	Type Designation
SYNC	Ford	SYNC-G4 SYNC-G4L

Argentina



Customer Information

Brazil



08657-19-01505

**Este equipamento não tem direito à proteção
contra interferência prejudicial e não pode causar
interferência em sistemas devidamente autorizados.**



08658-19-01505

**Este equipamento não tem direito à proteção
contra interferência prejudicial e não pode causar
interferência em sistemas devidamente autorizados.**

AGREE PAR LE MCPT (REPUBLIQUE DE DJIBOUTI)
Numéro d'agrément : 125/DDTIC/2019
Date d'agrément : 07/08/2019

European Union EU



Ghana

Djibouti

AGREE PAR LE MCPT (REPUBLIQUE DE DJIBOUTI)
Numéro d'agrément : 124/DDTIC/2019
Date d'agrément : 07/08/2019

NCA APPROVED: ZRO-1H-7E3-182

NCA APPROVED: ZRO-1H-7E3-180

Customer Information

Indonesia

Model: SYNC-G4
Sertifikat Nomor: 80700/SDPPI/2022
PLG ID: 13493



This product has been Type Approved by Jamaica: SMA – SYNC-G4L

Malaysia

Model: SYNC-G4L
Sertifikat Nomor: **81116**/SDPPI/2022
PLG ID: 13493



Jamaica

This product has been Type Approved by
Jamaica: SMA – SYNC-G4.

HIDF16000009

Mauritania

AGREE PAR L'ANE MAURITANIE
Numéro d'agrément : 0692/ARE/2018
Date d'agrément : 08/08/2019

Customer Information

AGREE PAR L'ANEMAURITANIE
Numéro d'agrément : 0691/ARE/2018
Date d'agrément : 08/08/2019

AGREE PAR L'ANRT MAROC
N° D'AGRÉMENT: MR 20606 ANRT 2019
07 AOUT 2019

Moldova



Pakistan



Morocco

AGREE PAR L'ANRT MAROC
N° D'AGRÉMENT: MR 20608 ANRT 2019
07 AOUT 2019

Paraguay



2020-03-I-00192
2020-03-I-00193

Customer Information

Serbia

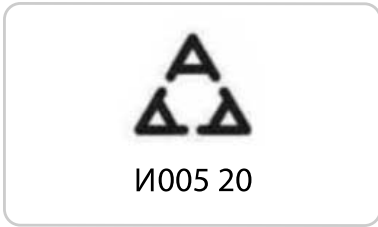

Singapore

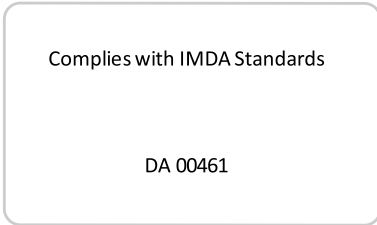

South Korea



South Africa



Taiwan

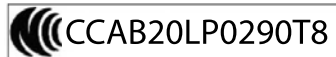

Customer Information

Ukraine

 CCAB20LP0300T1



United Arab Emirates (U.A.E.)

 <p>ER74903/19 United Arab Emirates</p>	
--	---

 <p>ER74902/19 United Arab Emirates</p>	
---	--

Customer Information

United Kingdom



This device complies with Part 15 of the FCC Rules and with Innovation, Science and Economic Development Canada's licence-exempt RSS(s). Operation is subject to the following two conditions:

1. This device may not cause harmful interference, and
2. This device must accept any interference received, including interference that may cause undesired operation.

United States and Canada



WARNING: Changes or modifications not expressly approved by the party responsible for compliance could void the user's authority to operate the equipment. The term "IC:" before the radio certification number only signifies that Industry Canada technical specifications were met.

FCC ID: KMH-SYNCG4

FCC ID: KMH-SYNCG4L

IC: 1422A-SYNCG4

IC: 1422A-SYNCG4L

Zambia



Customer Information

TELEMATICS CONTROL UNIT

Device	Supplier	Type Designation
Telematics Control Unit	Ford	FNV3-B6-NA FNV3-B6-ROW FNV3-B6-C FNV3-B6-C-V2X

Argentina



C-29802

China

- CMIIT ID: 2023CJ1792
- CMIIT ID: 2023CJ15969
- CMIIT ID: 2023CJ1792
- CMIIT ID: 2024CJ0557

European Union EU

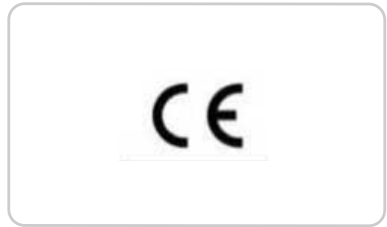

Malaysia



Customer Information

HIDF16000009

NR: 2023-01-I-0047

Mexico



Serbia



South Africa

Paraguay



South Korea



Customer Information

R-C-FDM-FNV3B6ROW



CCA235G0042T9

Taiwan

We recommend that the distance between the antenna of the telematics control unit and the user be greater than 35 cm (14 in) when using the telematics control unit.

United Arab Emirates (U.A.E.)



ER19896/23
United Arab Emirates



United Kingdom



United States and Canada

FCC ID: KMH-14H317-NA1

IC: 1422A-14H317NA1

Customer Information

This device complies with Part 15 of the FCC Rules and with Innovation, Science and Economic Development Canada's licence-exempt RSS(s). Operation is subject to the following two conditions:

1. This device may not cause harmful interference, and
2. This device must accept any interference received, including interference that may cause undesired operation.

L'émetteur/récepteur exempt de licence contenu dans le présent appareil est conforme aux CNR d'Innovation, Sciences et Développement économique Canada applicables aux appareils radio exempts de licence. L'exploitation est autorisée aux deux conditions suivantes:

1. L'appareil ne doit pas produire de brouillage;
2. L'appareil doit accepter tout brouillage radioélectrique subi, même si le brouillage est susceptible d'en compromettre le fonctionnement.

Note: Changes or modifications not expressly approved by the party responsible for compliance could void the user's authority to operate the equipment.

Nota: Tout changement apporté au dispositif sans l'approbation expresse des autorités compétentes pourrait révoquer le droit de l'utilisateur d'en faire usage.

Vietnam



TIRE PRESSURE MONITORING SYSTEM SENSORS

Device	Supplier	Type Designation
434 Faraday TPMS Sensor	Schrader/Sensata	AG2SZ4

Customer Information

Argentina



Democratic Republic of Congo

Agréé par l'ARPTC

N° d'homologation: HIR -0051/4/2014

Date d'homologation: 16/4/2014

Djibouti

AGREE PAR LE MCPT (REPUBLIQUE DE DJIBOUTI)

Numéro d'agrément : 198/MCPT/DDTCC

Date d'agrément : 7/9/2021

Brazil



18962-22-08001

China

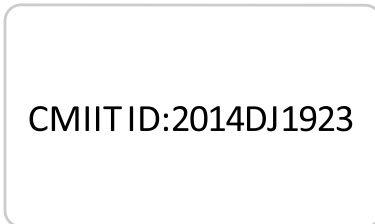

European Union (EU)

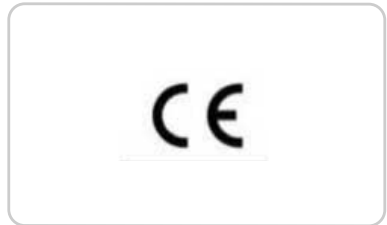

Customer Information

The RED 2014/53/EU (replacing R&TTE Directive 1999/5/EC on 13 June 2016) explicitly states that instructions for intentional radiators include reference to "(a) frequency band(s) in which the radio equipment operates; and (b) maximum radio-frequency power transmitted in the frequency band(s) in which the radio equipment operates," in addition to carrying over the general operational instruction and Declaration of Conformity inclusion requirements from the R&TTE Directive.

Hereby, Schrader Electronics Ltd. declares that the radio equipment type AG2SZ4 is in compliance with Directive 2014/53/EU. The full text of the EU declaration of conformity is available at the following internet address:

<https://www.schradertpms.com/en-gb/downloads>

f=433.92MHz

P<10mW (e.i.r.p)

Schrader Electronics Ltd. 11 Technology Park, Belfast Road, Antrim BT41 IQS, Northern Ireland United Kingdom.

Ghana

NCA APPROVED: 3R88M14030

Independent State of Samoa



Indonesia

Sertifikat Nomor: 90379/SDPPI/2023
PLG ID: 13493



Customer Information

Israel

1. מספר אישור התאמה מסעם משרד התקשורת: 51-88668
2. הול איסור לבצע פעולות במכשיר שיש בהן כדי לשנות את תכונותיו האלחוטיות של המכשיר, ובכלל זה שינוי תוכנה, החלפת אנטנה שקרית או הוספת אפשרות לחיבור לאנטנה חיצונית, בלא קבלת אישור משרד התקשורת, בעל החשב להפרצות אלו.

Mauritania

AGREE PAR L'ANEMAURITANIE
Numéro d'agrément : 0842/ARE/2020
Date d'agrément : 21/09/2020

Jamaica

This product has been Type Approved by
Jamaica: SMA - AG2SZ4

Malaysia



HIDF16000009

Mexico

IFT: RLVSCMR15-1238

Moldova



Morocco

AGREE PAR L'ANRT MAROC
Numéro d'agrément: MR9098
ANRT 2014
Date d'agrément: 14/03/2014

Customer Information

Nigeria

NR: 2022-01-I-0032

Connection and use of this communications equipment is permitted by the Nigerian Communications Commission

Pakistan



Oman

OMAN TRA
TA-R/1752/14
D090258

Russia



Paraguay



Sierra Leone



Customer Information

TAN: 2017-002-0035

Serbia



South Korea



MSIP-CRM-SRD-AG2SZ4

Singapore

Complies with IMDA Standards
DA 00461

Taiwan

South Africa



TA-2014/064
Approved



CCAM14LP0090T3

Thailand

- (1) เครื่องใช้โทรคมนาคมและอุปกรณ์นี้ ingsห้ามแสดงคือพามาข้อกำหนดของ กทท.
- (2) เครื่องใช้โทรคมนาคมนี้จะมีระดับการแผ่คลื่นแม่เหล็กไฟฟ้าที่สอดคล้องขงมาตรฐานความร่อดงข้อศูขง กทท.ของระบุมุข้กการำใช้ เพื่อรักษาความพรมที่คดงการร่อกการใ้โทรคมนาคมแห่งชาติประเทศไทย

Customer Information

Ukraine



United Arab Emirates (U.A.E)



United Kingdom



United States and Canada

FCC ID: MRXAG2SZ4

IC: 2546A-AG2SZ4

Customer Information

This device complies with Part 15 of the FCC Rules and with Innovation, Science and Economic Development Canada's licence-exempt RSS(s). Operation is subject to the following two conditions:

1. This device may not cause harmful interference, and
2. This device must accept any interference received, including interference that may cause undesired operation.

L'émetteur/récepteur exempt de licence contenu dans le présent appareil est conforme aux CNR d'Innovation, Sciences et Développement économique Canada applicables aux appareils radio exempts de licence. L'exploitation est autorisée aux deux conditions suivantes:

1. L'appareil ne doit pas produire de brouillage;
2. L'appareil doit accepter tout brouillage radioélectrique subi, même si le brouillage est susceptible d'en compromettre le fonctionnement.

Note: Changes or modifications not expressly approved by the party responsible for compliance could void the user's authority to operate the equipment.

Nota: Tout changement apporté au dispositif sans l'approbation expresse des autorités compétentes pourrait révoquer le droit de l'utilisateur d'en faire usage.

Vietnam



Zambia



TIRE PRESSURE MONITORING SYSTEM SENSORS

Device	Supplier	Type Designation
434 Steel Carcass TPMS Sensor	Schrader/Sensata	AG2FSC4

Customer Information

United States and Canada

 **WARNING:** Changes or modifications not expressly approved by the party responsible for compliance could void the user's authority to operate the equipment. The term "IC:" before the radio certification number only signifies that Industry Canada technical specifications were met.

FCC ID: MRXAG2FSC4

IC: 2546A-AG2FSC4

This device complies with Part 15 of the FCC Rules and with Innovation, Science and Economic Development Canada's licence-exempt RSS(s). Operation is subject to the following two conditions:

1. This device may not cause harmful interference, and
2. This device must accept any interference received, including interference that may cause undesired operation.

TIRE PRESSURE MONITORING SYSTEM SENSORS

Device	Supplier	Type Designation
Burnell TPM Sensor	Schrader/Sensata	BG2BP4

Argentina

CNC ID: H-28035



Brazil



Customer Information

13309-22-08001

European Union EU



The RED 2014/53/EU (replacing R&TTE Directive 1999/5/EC on 13 June 2016) explicitly states that instructions for intentional radiators include reference to "(a) frequency band(s) in which the radio equipment operates; and (b) maximum radio-frequency power transmitted in the frequency band(s) in which the radio equipment operates," in addition to carrying over the general operational instruction and Declaration of Conformity inclusion requirements from the R&TTE Directive.

Hereby, Schrader Electronics Ltd. declares that the radio equipment type BG2BP4 is in compliance with Directive 2014/53/EU. The full text of the EU declaration of conformity is available at the following internet address:

<https://www.schradertpms.com/en-gb/downloads>

f=433.92MHz

P<10mW (e.i.r.p)

Schrader Electronics Ltd. 11 Technology Park, Belfast Road, Antrim BT41 1QS, Northern Ireland United Kingdom.

Israel

Jamaica

This product has been Type Approved by Jamaica: SMA - BG2BP4.

1. מספר אישור התאמה מסעם משרד התקשורת: 51-86230
2. חל אישור לבצע פעולות במכשיר שיש בהן כדי לשנות את תכונותיו האלחוטיות של המכשיר, ובכלל זה שינוי תוכנה, החלפת אנטנה מקורית או הוספת אפשרות לתיבור לאנטנה חיצונית, בלא קבלת אישור משרד התקשורת, בשל החשש להפרעות אלחוטיות.

Customer Information

Malaysia



HIDF16000009

Mexico

IFT: RLVSCBG22-2502

Moldova



Morocco

AGREE PAR L'ANRT MAROC

Numéro d'agrément:
MR00034968ANRT2022

Date d'agrément: 21/12/2022

Paraguay



NR: 2022-05-I-0000331

Serbia



Customer Information

Singapore

Complies with IMDA Standards

DA 00461

MSIP-R-C-SRD-BG2BP4

Taiwan



CCAB22LP0730T0

South Africa



Thailand

- (1) เครื่องใช้โทรคมนาคมและอุปกรณ์นี้ มีความสอดคล้องตามข้อกำหนดของ กทท.
- (2) เครื่องใช้โทรคมนาคมและอุปกรณ์นี้ได้รับการแนบมาเพื่อให้ผู้ที่สอดคล้องของกรมการสื่อสารโทรคมนาคมตรวจสอบคุณภาพของมนุษย์ ากการรับใช้ หรือรับข้อมูลนามที่คณะกรรมการกิจการโทรคมนาคมแห่งชาติประกาศ

South Korea



Ukraine



Customer Information

Unites Arab Emirates (U.A.E.)



United Kingdom



United States and Canada

FCC ID: MRXBG2BP4

IC: 2546A-BG2BP4

This device complies with Part 15 of the FCC Rules and with Innovation, Science and Economic Development Canada's licence-exempt RSS(s). Operation is subject to the following two conditions:

1. This device may not cause harmful interference, and
2. This device must accept any interference received, including interference that may cause undesired operation.

L'émetteur/récepteur exempt de licence contenu dans le présent appareil est conforme aux CNR d'Innovation, Sciences et Développement économique Canada applicables aux appareils radio exempts de licence. L'exploitation est autorisée aux deux conditions suivantes:

1. L'appareil ne doit pas produire de brouillage;
2. L'appareil doit accepter tout brouillage radioélectrique subi, même si le brouillage est susceptible d'en compromettre le fonctionnement.

Note: Changes or modifications not expressly approved by the party responsible for compliance could void the user's authority to operate the equipment.

Nota: Tout changement apporté au dispositif sans l'approbation expresse des autorités compétentes pourrait révoquer le droit de l'utilisateur d'en faire usage.

Customer Information

TIRE PRESSURE MONITORING SYSTEM SENSORS

Device	Supplier	Type Designation
434 Faraday Gen 6 TPMS Sensor	Schrader/Sensata	FP4

Argentina



China

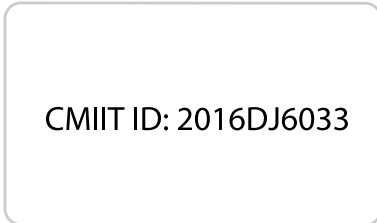

Democratic Republic of Congo

Agréé par l'ARPTC

N° d'homologation: HIR-0099/09/2016

Date d'homologation: 15/09/2016

Djibouti



European Union (EU)

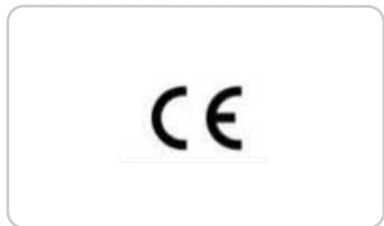

Customer Information

The RED 2014/53/EU (replacing R&TTE Directive 1999/5/EC on 13 June 2016) explicitly states that instructions for intentional radiators include reference to "(a) frequency band(s) in which the radio equipment operates; and (b) maximum radio-frequency power transmitted in the frequency band(s) in which the radio equipment operates," in addition to carrying over the general operational instruction and Declaration of Conformity inclusion requirements from the R&TTE Directive.

Hereby, Schrader Electronics Ltd. declares that the radio equipment type FP4 is in compliance with Directive 2014/53/EU. The full text of the EU declaration of conformity is available at the following internet address:

<https://www.schradertpms.com/en-gb/downloads>

f=433.92MHz

P<10mW (e.i.r.p)

Schrader Electronics Ltd. 11 Technology Park, Belfast Road, Antrim BT41 IQS, Northern Ireland United Kingdom.

Ghana

Israel

NCA APPROVED: 2R9-8M-7E0-0BE

1. מספר אישור התאמה מסוג שרדר התקשורת: 51-83847
2. חל אישור לבצע פעולות במכשיר שיש בו כדי לשנות את תכונותיו האלחוטיות של המכשיר, ובכלל זה שינוי תוכנה, החלפת אנטנה מקבוצת או הוספת אפשרות לתיבור לאנטנה חיצונית, בלא קבלת אישור משרד התקשורת, בשל החשש להפרעת אלחוטיות.

Independent State of Samoa



Customer Information

Jamaica

This product has been Type Approved by
Jamaica: SMA - FP4.

Mauritania

AGREE PAR L'ANE MAURITANIE
Numéro d'agrément : 0358/ARE/2016
Date d'agrément : 04/10/2016

Moldova



Nigeria

Connection and use of this
communications
equipment is permitted by the Nigerian
Communications Commission

Oman

OMAN TRA
TA-R/3591/16
D080134

Pakistan

Pakistan Telecommunication Authority



Approved by PTA 2016

Paraguay



Customer Information

Serbia

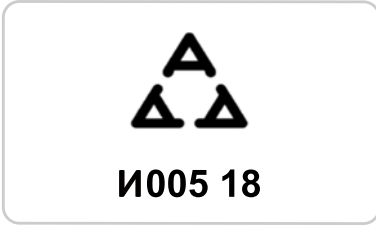

TAN: 2016-002-0035

South Korea



Ukraine



Sierra Leone



Unites Arab Emirates (U.A.E.)



Customer Information

United Kingdom



United States and Canada

FCC ID: MRXFP4

IC: 2546A-FP4

This device complies with Part 15 of the FCC Rules and with Innovation, Science and Economic Development Canada's licence-exempt RSS(s). Operation is subject to the following two conditions:

1. This device may not cause harmful interference, and
2. This device must accept any interference received, including interference that may cause undesired operation.

L'émetteur/récepteur exempt de licence contenu dans le présent appareil est conforme aux CNR d'Innovation, Sciences et Développement économique Canada applicables aux appareils radio exempts de licence. L'exploitation est autorisée aux deux conditions suivantes:

1. L'appareil ne doit pas produire de brouillage;
2. L'appareil doit accepter tout brouillage radioélectrique subi, même si le brouillage est susceptible d'en compromettre le fonctionnement.

Note: Changes or modifications not expressly approved by the party responsible for compliance could void the user's authority to operate the equipment.

Nota: Tout changement apporté au dispositif sans l'approbation expresse des autorités compétentes pourrait révoquer le droit de l'utilisateur d'en faire usage.

WIRELESS ACCESSORY CHARGING MODULE

Device	Supplier	Type Designation
Wireless Charger (WCM)	LG/BH EVS	WC FDM00N2A1
		WC FDM00N2A3
		WC FDM00N2A5

Customer Information

Argentina



Brazil



Democratic Republic of Congo

Agréé par l'ARPTC

N° d'homologation: HER-062/Avril/2023

Date d'homologation: 28/4/2023

European Union

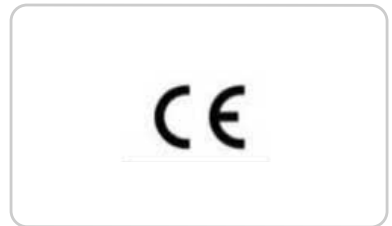

Ghana

NCA APPROVED: 7ES-7M-XB1-RDR

Customer Information

Indonesia

Model: WCFDM00N2A1
Sertifikat Nomor: 80110/SDPPI/2022
PLG ID: 13493



Model: WCFDM00N2A3
Sertifikat Nomor: 80111/SDPPI/2022
PLG ID: 13493



Model: WCFDM00N2A5
Sertifikat Nomor: 80112/SDPPI/2022
PLG ID: 13493



Israel

1. מספר אישור התאמה מטעם משרד התקשורת: 51-80014
2. חל אישור לבצע פעולות במבטיר שיש בהן כדי לשנות את תכונותיו האלחוטיות של המכשיר, ובכלל זה שינויי תוכנה, החלפת אנטנה מקורית או הספת אפשרות לחיבור לאנטנה חיצונית, בלא קבלת אישור משרד התקשורת, ביטול ההשגש הפרטות אלחוטיות

1. מספר אישור התאמה מטעם משרד התקשורת: 51-80015
2. חל אישור לבצע פעולות במבטיר שיש בהן כדי לשנות את תכונותיו האלחוטיות של המכשיר, ובכלל זה שינויי תוכנה, החלפת אנטנה מקורית או הספת אפשרות לחיבור לאנטנה חיצונית, בלא קבלת אישור משרד התקשורת, ביטול ההשגש הפרטות אלחוטיות

1. מספר אישור התאמה מטעם משרד התקשורת: 51-80013
2. חל אישור לבצע פעולות במבטיר שיש בהן כדי לשנות את תכונותיו האלחוטיות של המכשיר, ובכלל זה שינויי תוכנה, החלפת אנטנה מקורית או הספת אפשרות לחיבור לאנטנה חיצונית, בלא קבלת אישור משרד התקשורת, ביטול ההשגש הפרטות אלחוטיות

Jamaica

This product has been Type Approved by Jamaica:
SMA - WCFDM00N2A.

Customer Information

Malaysia



AGREE PAR L'ANE MAURITANIE
Numéro d'agrément : 0933/ARE/2021
Date d'agrément : 23/03/2021

HIDF16000009

Mauritania

AGREE PAR L'ANE MAURITANIE
Numéro d'agrément : 0935/ARE/2021
Date d'agrément : 23/03/2021

AGREE PAR L'ANE MAURITANIE
Numéro d'agrément : 0934/ARE/2021
Date d'agrément : 23/03/2021

Moldova



Morocco

AGREE PAR L'ANRT MAROC
Numéro d'agrément : MR 00027924ANRT 2021
Date d'agrément : 25/03/2021

Customer Information

Russia

AGREE PAR L'ANRT MAROC
Numéro d'agrément : MR 00027925ANRT 2021
Date d'agrément : 25/03/2021



Serbia

AGREE PAR L'ANRT MAROC
Numéro d'agrément : MR 00027923ANRT 2021
Date d'agrément : 25/03/2021



W005 21

Sierra Leone

Paraguay



TAN: 2021-002-0099

NR: 2021-04-I-0202

NR: 2021-04-I-0203

NR: 2021-04-I-0204

Customer Information

Singapore

Complies with IMDA Standards

DA 00461

South Korea



R-R-LGE-WCFDM00N2A1

South Africa



Taiwan



CCAB21LP050AT3



CCAB21LP0500T1



CCAB21LP050BT5

品名 (Product name): 無線充電座

型號 (Type Designation): WCFDM00N2A1, WCFDM00N2A3, WCFDM00N2A5 **產地 (Origin):** 馬來西亞

額定電壓 (Input rating): 12V

製造日期 (Approval date): 2021.04.21



R43208
Rolls

申請廠商名稱 (Approval name): 福特六和汽車股份有限公司

申請廠商地址 (Approval address): 桃園市中壢區中華路一段705號

Customer Information

Ukraine



United Kingdom



United Arab Emirates (U.A.E.)



Customer Information

TDRA

ER00421/21
United Arab Emirates



United States and Canada

IC: 2703H-WCFDMOON2A

FCC ID: BEJWCFDMOON2A

This equipment generates, uses, and can radiate radio frequency energy and may cause harmful interference to radio communications. There is no guarantee that interference will not occur in a particular installation. If this equipment does cause harmful interference to radio or television reception, please consult the dealer.

This product is not end-user serviceable.

RF Radiation Exposure Statement: This equipment complies with FCC RF Radiation exposure limits set forth for an uncontrolled environment. This device and its antenna must not be co-located or operating in conjunction with any other antenna or transmitter. This equipment should be installed and operated with a minimum distance of 20cm between the radiator and your body.

This device complies with Part 15 of the FCC Rules and with Innovation, Science and Economic Development Canada's licence-exempt RSS(s). Operation is subject to the following two conditions:

1. This device may not cause harmful interference, and
2. This device must accept any interference received, including interference that may cause undesired operation.

Le présent appareil est conforme aux CNR d'Industrie Canada applicables aux appareils radio exempts de licence. L'exploitation est autorisée aux deux conditions suivantes:

1. *L'appareil ne doit pas produire de brouillage;*
2. *L'appareil doit accepter tout brouillage radioélectrique subi, même si le brouillage est susceptible d'en compromettre le fonctionnement.*

Customer Information

Vietnam



REPLACEMENT PARTS RECOMMENDATION

We have built your vehicle to the highest standards using quality parts. We recommend that you demand the use of genuine Ford and Motorcraft parts whenever your vehicle requires scheduled maintenance or repair. You can clearly identify genuine Ford and Motorcraft parts by looking for the Ford, FoMoCo or Motorcraft branding on the parts or their packaging.

Zambia



Scheduled Maintenance and Mechanical Repairs

One of the best ways for you to make sure that your vehicle provides years of service is to have it maintained in line with our recommendations using parts that conform to the specifications detailed in this Owner's Manual.

Genuine Ford and Motorcraft parts meet or exceed these specifications.

Collision Repairs

We hope that you never experience a collision, but accidents happen sometimes.

Genuine Ford replacement collision parts meet our stringent requirements for fit, finish, structural integrity, corrosion protection and dent resistance. During vehicle development we validate that these parts deliver the intended level of protection as a whole system. A great way to know for sure you are getting this level of protection is to use genuine Ford replacement collision parts.

PERCHLORATE

Certain components in your vehicle such as airbag modules, seatbelt pretensioners and remote control batteries may contain perchlorate material. Special handling may apply for service or vehicle end of life disposal.

For more information visit:
www.dtsc.ca.gov/hazardouswaste/perchlorate.

Warranty on Replacement Parts

Genuine Ford and Motorcraft replacement parts are the only replacement parts that benefit from a Ford Warranty.

Customer Information

The Ford Warranty may not cover damage caused to your vehicle as a result of failed non-Ford parts.

For additional information, refer to the terms and conditions of the Ford Warranty.

MOBILE COMMUNICATIONS EQUIPMENT



WARNING: Driving while distracted can result in loss of vehicle control, crash and injury. We strongly recommend that you use extreme caution when using any device that may take your focus off the road. Your primary responsibility is the safe operation of your vehicle. We recommend against the use of any hand-held device while driving and encourage the use of voice-operated systems when possible. Make sure you are aware of all applicable local laws that may affect the use of electronic devices while driving.

Using mobile communications equipment is becoming increasingly important in the conduct of business and personal affairs. However, you must not compromise your own or others' safety when using such equipment. Mobile communications can enhance personal safety and security when appropriately used, particularly in emergency situations. Safety must be paramount when using mobile communications equipment to avoid negating these benefits. Mobile communication equipment includes, but is not limited to, cellular phones, pagers, portable email devices, text messaging devices and portable two-way radios.

FEDERAL HIGHWAY ADMINISTRATION REGULATION

Regulations such as those issued by the Federal Highway Administration or issued pursuant to the Occupational Safety and Health Act (OSHA), and state and local laws and regulations may require additional equipment for the way you intend to use your vehicle. It is the responsibility of the registered owner to determine the applicability of such laws and regulations to your intended use for the vehicle, and to arrange for the installation of required equipment. The dealer has information about the availability of equipment which can be ordered for your vehicle.

Customer Information

END USER LICENSE AGREEMENT

VEHICLE SOFTWARE END USER LICENSE AGREEMENT (EULA)

- You ("You" or "Your" as applicable) have acquired a vehicle having several devices, including SYNC ® and various control modules, ("DEVICES") that include software licensed or owned by Ford Motor Company and its affiliates ("FORD MOTOR COMPANY"). Those software products of FORD MOTOR COMPANY origin, as well as associated media, printed materials, and "online" or electronic documentation ("SOFTWARE") are protected by international intellectual property laws and treaties. The SOFTWARE is licensed, not sold. All rights reserved.
- The SOFTWARE may interface with and/or communicate with, or may be later upgraded to interface with and/or communicate with additional software and/or systems provided by FORD MOTOR COMPANY.

IF YOU DO NOT AGREE TO THIS END USER LICENSE AGREEMENT ("EULA") DO NOT USE THE DEVICES OR COPY THE SOFTWARE. ANY USE OF THE SOFTWARE, INCLUDING BUT NOT LIMITED TO USE ON THE DEVICES, WILL CONSTITUTE YOUR AGREEMENT TO THIS EULA (OR RATIFICATION OF ANY PREVIOUS CONSENT).

GRANT OF SOFTWARE LICENSE: This EULA grants you the following license:

- You may use the SOFTWARE as installed on the DEVICES and as otherwise interfacing with systems and/or services provide by or through FORD MOTOR COMPANY or its third party software and service providers.

Description of Other Rights and Limitations.

- **Speech Recognition:** If the SOFTWARE includes speech recognition component(s), you should understand that speech recognition is an inherently statistical process and that recognition errors are inherent in the process. Neither FORD MOTOR COMPANY nor its suppliers shall be liable for any damages arising out of errors in the speech recognition process. It is your responsibility to monitor any speech recognition functions included in the system.
- **Limitations on Reverse Engineering, Decompilation and Disassembly:** You may not reverse engineer, decompile, translate, disassemble or attempt to discover any source code or underlying ideas or algorithms of the SOFTWARE nor permit others to reverse engineer, decompile or disassemble the SOFTWARE, except and only to the extent that such activity is expressly permitted by applicable law notwithstanding this limitation or to the extent as may be permitted by the licensing terms governing use of any open source components included with the SOFTWARE.
- **Limitations on Distributing, Copying, Modifying and Creating Derivative Works:** You may not distribute, copy, make modifications to or create derivative works based on the SOFTWARE, except and only to the extent that such activity is expressly permitted by applicable law notwithstanding this limitation or to the extent as may be permitted by the licensing terms governing use of any open source components included with the SOFTWARE.

Customer Information

- **Single EULA:** The end user documentation for the DEVICES and related systems and services may contain multiple EULAs, such as multiple translations and/or multiple media versions (e.g., in the user documentation and in the software). Even if you receive multiple EULAs, you are licensed to use only one (1) copy of the SOFTWARE.
- **SOFTWARE Transfer:** You may permanently transfer your rights under this EULA only as part of a sale or transfer of the DEVICES, provided you retain no copies, you transfer all of the SOFTWARE (including all component parts, the media and printed materials, any upgrades, and, if applicable, the Certificate(s) of Authenticity), and the recipient agrees to the terms of this EULA. If the SOFTWARE is an upgrade, any transfer must include all prior versions of the SOFTWARE.
- **Termination:** Without prejudice to any other rights, FORD MOTOR COMPANY may terminate this EULA if you fail to comply with the terms and conditions of this EULA.
- **Internet-Based Services Components:** The SOFTWARE may contain components that enable and facilitate the use of certain Internet-based services. You acknowledge and agree that FORD MOTOR COMPANY, third party software and service suppliers, its affiliates and/or its designated agent may automatically check the version of the SOFTWARE and/or its components that you are utilizing and may provide upgrades or supplements to the SOFTWARE that may be automatically downloaded to your DEVICES.
- **Additional Software/Services:** The SOFTWARE may permit FORD MOTOR COMPANY, third party software and service suppliers, its affiliates and/or its designated agent to provide or make available to you SOFTWARE updates, supplements, add-on components, or Internet-based services components of the SOFTWARE after the date you obtain your initial copy of the SOFTWARE ("Supplemental Components".) SOFTWARE updates may cause you to incur additional charges from your wireless service provider. If FORD MOTOR COMPANY or third party software and services suppliers provide or make available to you Supplemental Components and no other EULA terms are provided along with the Supplemental Components, then the terms of this EULA shall apply. FORD MOTOR COMPANY, its affiliates and/or its designated agent reserve the right to discontinue without liability any Internet-based services provided to you or made available to you through the use of the SOFTWARE.

Customer Information

- **Links to Third Party Sites:** The SOFTWARE may provide you with the ability to link to third party sites. The third party sites are not under the control of FORD MOTOR COMPANY, its affiliates and/or its designated agent. Neither FORD MOTOR COMPANY nor its affiliates nor its designated agent are responsible for (i) the contents of any third party sites, any links contained in third party sites, or any changes or updates to third party sites, or (ii) webcasting or any other form of transmission received from any third party sites. If the SOFTWARE provides links to third party sites, those links are provided to you only as a convenience, and the inclusion of any link does not imply an endorsement of the third party site by FORD MOTOR COMPANY, its affiliates and/or its designated agent.
- **Obligation to Drive Responsibly:** You recognize your obligation to drive responsibly and keep attention on the road. You will read and abide with the DEVICES operating instructions particularly as they pertain to safety and you agree to assume any risk associated with the use of the DEVICES.

UPGRADES AND RECOVERY MEDIA:

If the SOFTWARE is provided by FORD MOTOR COMPANY separate from the DEVICES on media such as a ROM chip, CD ROM disk(s) or via web download or other means, and is labeled "For Upgrade Purposes Only" or "For Recovery Purposes Only" you may install one (1) copy of such SOFTWARE onto the DEVICES as a replacement copy for the existing SOFTWARE, and use it in accordance with this EULA, including any additional EULA terms accompanying the upgrade SOFTWARE.

INTELLECTUAL PROPERTY RIGHTS:

All title and intellectual property rights in and to the SOFTWARE (including but not limited to any images, photographs, animations, video, audio, music, text and "applets" incorporated into the SOFTWARE), the accompanying printed materials, and any copies of the SOFTWARE, are owned by FORD MOTOR COMPANY, or its affiliates or suppliers. The SOFTWARE is licensed, not sold. You may not copy the printed materials accompanying the SOFTWARE. All title and intellectual property rights in and to the content which may be accessed through use of the SOFTWARE is the property of the respective content owner and may be protected by applicable copyright or other intellectual property laws and treaties. This EULA grants you no rights to use such content outside its intended use. All rights not specifically granted under this EULA are reserved by FORD MOTOR COMPANY, its affiliates, and third party software and service providers and suppliers. Use of any on-line services which may be accessed through the SOFTWARE may be governed by the respective terms of use relating to such services. If this SOFTWARE contains documentation that is provided only in electronic form, you may print one copy of such electronic documentation.

EXPORT RESTRICTIONS: You acknowledge that the SOFTWARE is subject to U.S. and European Union export jurisdiction. You agree to comply with all applicable international and national laws that apply to the SOFTWARE, including the U.S. Export Administration Regulations, as well as end-user, end-use and destination restrictions issued by U.S. and other governments.

Customer Information

TRADEMARKS: This EULA does not grant you any rights in connection with any trademarks or service marks of FORD MOTOR COMPANY, its affiliates, and third party software and service providers.

PRODUCT SUPPORT: Please refer to FORD MOTOR COMPANY instructions provided in the documentation for the DEVICES product support, such as the vehicle owner guide.

Should you have any questions concerning this EULA, or if you desire to contact FORD MOTOR COMPANY for any other reason, please refer to the address provided in the documentation for the DEVICES.

No Liability for Certain Damages: EXCEPT AS PROHIBITED BY LAW, FORD MOTOR COMPANY, ANY THIRD PARTY SOFTWARE OR SERVICES SUPPLIERS, AND THEIR AFFILIATES SHALL HAVE NO LIABILITY FOR ANY INDIRECT, SPECIAL, CONSEQUENTIAL OR INCIDENTAL DAMAGES ARISING FROM OR IN CONNECTION WITH THE USE OR PERFORMANCE OF THE SOFTWARE. THIS LIMITATION SHALL APPLY EVEN IF ANY REMEDY FAILS OF ITS ESSENTIAL PURPOSE. THERE ARE NO WARRANTIES OTHER THAN THOSE THAT MAY BE EXPRESSLY PROVIDED FOR YOUR NEW VEHICLE.

SYNC® Automotive Important Safety Information Read and follow instructions:

- Before using your SYNC® system, read and follow all instructions and safety information provided in this end user manual ("Owner Guide".) Not following precautions found in the Owner Guide can lead to an accident or other serious injuries.

General Operation

- **Voice Command Control:** Certain functions within the SYNC® system may be accomplished using voice commands. Using voice commands while driving helps you to operate the system without removing your hands from the wheel or eyes from the road.
- **Prolonged Views of Screen:** Do not access any function requiring a prolonged view of the screen while you are driving. Pull over in a safe and legal manner before attempting to access a function of the system requiring prolonged attention.
- **Volume Setting:** Do not raise the volume excessively. Keep the volume at a level where you can still hear outside traffic and emergency signals while driving. Driving while unable to hear these sounds could cause an accident.
- **Navigation Features:** Any navigation features included in the system are intended to provide turn by turn instructions to get you to a desired destination. Please make certain all persons using this system carefully read and follow instructions and safety information fully.
- **Distraction Hazard:** Any navigation features may require manual (non-verbal) setup. Attempting to perform such set-up or insert data while driving can distract your attention and could cause an accident or other serious injury. Stop the vehicle in a safe and legal manner before attempting these operations.
- **Let Your Judgment Prevail:** Any navigation features are provided only as an aid. Make your driving decisions based on your observations of local conditions and existing traffic regulations. Any such feature is not a

Customer Information

substitute for your personal judgment. Any route suggestions made by this system should never replace any local traffic regulations or your personal judgment or knowledge of safe driving practices.

- **Route Safety:** Do not follow the route suggestions if doing so would result in an unsafe or illegal maneuver, if you would be placed in an unsafe situation, or if you would be directed into an area that you consider unsafe. The driver is ultimately responsible for the safe operation of the vehicle and therefore, must evaluate whether it is safe to follow the suggested directions.
- **Potential Map Inaccuracy:** Maps used by this system may be inaccurate because of changes in roads, traffic controls or driving conditions. Always use good judgment and common sense when following the suggested routes.
- **Emergency Services:** Do not rely on any navigation features included in the system to route you to emergency services. Ask local authorities or an emergency services operator for these locations. Not all emergency services such as police, fire stations, hospitals and clinics are likely to be contained in the map database for such navigation features.

Your Responsibilities and Assumptions of Risk

- You agree to each of the following:(a) Any use of the SOFTWARE while driving an automobile or other vehicle in violation of applicable law or otherwise driving in an unsafe manner presents a significant risk of distracted driving and should not be attempted under any circumstances;(b) Use of the SOFTWARE at excessive volume poses a significant risk of hearing damage and should not be attempted under any circumstances;(c) The SOFTWARE may not be compatible with new or different versions of an operating system, third party software, or third party services, and the SOFTWARE may potentially cause a critical failure of an operating system, third party software, or third party service.(d) Any third party service accessed by or third party software used with the SOFTWARE (i) may charge an additional fee for access, (ii) may not work correctly, on an uninterrupted basis, or error free, (iii) may change streaming formats or discontinue operation, (iv) may contain adult, profane or offensive content; and (v) may contain inaccurate, false or misleading traffic, weather, financial or safety information or other content; and (e) Use of the SOFTWARE may cause you to incur additional charges from your wireless service provider (WSP) and any data or minute calculators that may be included in the software program are for reference only, are not warranted in any way and should not be relied upon in anyway.
- When using the SOFTWARE, you agree to be responsible for and assume the entire risk to the items set forth in Section (a) – (e) above.

Customer Information

Disclaimer of Warranty

YOU EXPRESSLY ACKNOWLEDGE AND AGREE THAT USE OF THE DEVICES AND SOFTWARE IS AT YOUR SOLE RISK AND THAT THE ENTIRE RISK AS TO SATISFACTORY QUALITY, PERFORMANCE, COMPATIBILITY, ACCURACY AND EFFORT IS WITH YOU. TO THE MAXIMUM EXTENT PERMITTED BY APPLICABLE LAW, THE SOFTWARE AND ANY THIRD PARTY SOFTWARE OR THIRD-PARTY SERVICES ARE PROVIDED "AS IS" AND "AS AVAILABLE", WITH ALL FAULTS AND WITHOUT WARRANTY OF ANY KIND, AND FORD MOTOR COMPANY HEREBY DISCLAIMS ALL WARRANTIES AND CONDITIONS WITH RESPECT TO THE SOFTWARE, THIRD PARTY SOFTWARE, AND THIRD-PARTY SERVICES, EITHER EXPRESS, IMPLIED OR STATUTORY, INCLUDING, BUT NOT LIMITED TO, THE IMPLIED WARRANTIES AND/OR CONDITIONS OF MERCHANTABILITY, OF SATISFACTORY QUALITY, OF FITNESS FOR AN PARTICULAR PURPOSE, OF ACCURACY, OF QUIET ENJOYMENT, AND NON-INFRINGEMENT OF THIRD-PARTY RIGHTS. FORD MOTOR COMPANY DOES NOT WARRANT (a) AGAINST INTERFERENCE WITH YOUR ENJOYMENT OF THE SOFTWARE, THIRD PARTY SOFTWARE, OR THIRD-PARTY SERVICES, (b) THAT THE SOFTWARE, THIRD PARTY SOFTWARE, OR THIRD-PARTY SERVICES WILL MEET YOUR REQUIREMENTS, (c) THAT THE OPERATION OF THE SOFTWARE, THIRD PARTY SOFTWARE, OR THIRD-PARTY SERVICES WILL BE UNINTERRUPTED OR ERROR-FREE, (d) OR THAT DEFECTS IN THE SOFTWARE, THIRD PARTY SOFTWARE, OR THIRD-PARTY SERVICES WILL BE CORRECTED. NO ORAL OR WRITTEN INFORMATION OR ADVICE GIVEN BY FORD MOTOR COMPANY OR ITS AUTHORIZED REPRESENTATIVE SHALL

CREATE A WARRANTY. SHOULD THE SOFTWARE, THIRD PARTY SOFTWARE, OR THIRD-PARTY SERVICES PROVE DEFECTIVE, YOU ASSUME THE ENTIRE COST OF ALL NECESSARY SERVICING, REPAIR OR CORRECTION. SOME JURISDICTIONS DO NOT ALLOW THE DISCLAIMER OF IMPLIED WARRANTIES OR LIMITATIONS ON APPLICABLE STATUTORY RIGHTS OF A CONSUMER, SO THE ABOVE DISCLAIMER MAY NOT FULLY APPLY TO YOU. THE SOLE WARRANTY PROVIDED BY FORD MOTOR COMPANY SHALL BE FOUND IN THE WARRANTY INFORMATION INCLUDING WITH YOUR OWNER GUIDE. TO THE EXTENT THAT THERE IS ANY CONFLICT BETWEEN THE TERMS OF THIS SECTION AND THE WARRANTY BOOKLET, THE WARRANTY BOOKLET SHALL CONTROL.

Applicable Law, Venue, Jurisdiction

- The laws of the State of Michigan govern this EULA and Your use of the SOFTWARE. Your use of the SOFTWARE may also be subject to other local, state, national, or international laws. Any litigation arising out of or related to this EULA shall be brought and maintained exclusively in a court of the State of Michigan located in Wayne County or in the United States District Court for the Eastern District of Michigan. You hereby consent to submit to the personal jurisdiction of a court in the State of Michigan located in Wayne County and the United States District Court for the Eastern District of Michigan for any dispute arising out of or relating to this EULA.

Customer Information

Binding Arbitration and Class Action Waiver

(a) Application. This Section applies to any dispute EXCEPT IT DOES NOT INCLUDE A DISPUTE RELATING TO COPYRIGHT INFRINGEMENT, OR TO THE ENFORCEMENT OR VALIDITY OF YOUR, FORD MOTOR COMPANY, OR ANY OF FORD MOTOR COMPANY'S LICENSORS' INTELLECTUAL PROPERTY RIGHTS. Dispute means any dispute, action, or other controversy between You and FORD MOTOR COMPANY, other than the exceptions listed above, concerning the SOFTWARE (including its price) or this EULA, whether in contract, warranty, tort, statute, regulation, ordinance, or any other legal or equitable basis.

(b) Notice of Dispute. In the event of a Dispute, You or FORD MOTOR COMPANY must give the other a "Notice of Dispute", which is a written statement of the name, address, and contact information of the party giving it, the facts giving rise to the dispute, and the relief requested. You and FORD MOTOR COMPANY will attempt to resolve any dispute through informal negotiation within 60 days from the date the Notice of Dispute is sent. After 60 days, You or FORD MOTOR COMPANY may commence arbitration.

(c) Small claims court. You may also litigate any dispute in small claims court in your county of residence or FORD MOTOR COMPANY'S principal place of business, if the dispute meets all requirements to be heard in the small claims court. You may litigate in small claims court whether or not You negotiated informally first.

(d) Binding arbitration. If You and FORD MOTOR COMPANY, do not resolve any dispute by informal negotiation or in small claims court, any other effort to resolve the dispute will be conducted exclusively by binding arbitration. You are giving up

the right to litigate (or participate in as a party or class member) all disputes in court before a judge or jury. Instead, all disputes will be resolved before a neutral arbitrator, whose decision will be final except for a limited right of appeal under the Federal Arbitration Act. Any court with jurisdiction over the parties may enforce the arbitrator's award.

(e) Class action waiver. Any proceedings to resolve or litigate any dispute in any forum will be conducted solely on an individual basis. Neither you nor FORD MOTOR COMPANY, will seek to have any dispute heard as a class action, as a private attorney general action, or in any other proceeding in which any party acts or proposes to act in a representative capacity. No arbitration or proceeding will be combined with another without the prior written consent of all parties to all affected arbitrations or proceedings.

(f) Arbitration procedure. Any arbitration will be conducted by the American Arbitration Association (the "AAA"), under its Commercial Arbitration Rules. If You are an individual and use the SOFTWARE for personal or vehicle use, or if the value of the dispute is \$75,000 or less whether or not You are an individual or how You use the SOFTWARE, the AAA Supplementary Procedures for Consumer-Related Disputes will also apply. To commence arbitration, submit a Commercial Arbitration Rules Demand for Arbitration form to the AAA. You may request a telephonic or in-person hearing by following the AAA rules. In a dispute involving \$10,000 or less, any hearing will be telephonic unless the arbitrator finds good cause to hold an in-person hearing instead. For more information, see adr.org or call 1-800-778-7879. You agree to commence arbitration only in your county of residence or FORD MOTOR COMPANY'S principal place of business. The arbitrator

Customer Information

may award the same damages to you individually as a court could. The arbitrator may award declaratory or injunctive relief only to you individually, and only to the extent required to satisfy your individual claim.

(g) Arbitration fees and incentives.

- I. Disputes involving \$75,000 or less. FORD MOTOR COMPANY will promptly reimburse your filing fees and pay the AAA's and arbitrator's fees and expenses. If you reject FORD MOTOR COMPANY'S last written settlement offer made before the arbitrator was appointed ("last written offer"), your dispute goes all the way to an arbitrator's decision (called an "award"), and the arbitrator awards you more than the last written offer, FORD MOTOR COMPANY will give you three incentives: (1) pay the greater of the award or \$1,000; (2) pay twice your reasonable attorney's fees, if any; and (3) reimburse any expenses (including expert witness fees and costs) that your attorney reasonably accrues for investigating, preparing, and pursuing your claim in arbitration. The arbitrator will determine the amounts.
- ii. Disputes involving more than \$75,000. The AAA rules will govern payment of filing fees and the AAA's and arbitrator's fees and expenses.
- iii. Disputes involving any amount. In any arbitration you commence, FORD MOTOR COMPANY will seek its AAA or arbitrator's fees and expenses, or Your filing fees it reimbursed, only if the arbitrator finds the arbitration frivolous or brought for an improper purpose. In any arbitration FORD MOTOR COMPANY commences, it will pay all

filing, AAA, and arbitrator's fees and expenses. It will not seek its attorney's fees or expenses from you in any arbitration. Fees and expenses are not counted in determining how much a dispute involves.

(h) Claims or disputes must be filed within one year. To the extent permitted by law, any claim or dispute under this EULA to which this Section applies must be filed within one year in small claims court (Section c) or in arbitration (Section d). The one-year period begins when the claim or dispute first could be filed. If such a claim or dispute is not filed within one year, it is permanently barred.

(i) Severability. If the class action waiver (Section e) is found to be illegal or unenforceable as to all or some parts of a dispute, then that portion of Section e will not apply to those parts. Instead, those parts will be severed and proceed in a court of law, with the remaining parts proceeding in arbitration. If any other provision of that portion Section e is found to be illegal or unenforceable, that provision will be severed with the remainder of Section e remaining in full force and effect.

Telenav Software End User License Agreement

Please read these terms and conditions carefully before you use the TeleNav Software. Your use of the TeleNav Software indicates that you accept these terms and conditions. If you do not accept these terms and conditions, do not break the seal of the package, launch, or otherwise use the TeleNav Software. TeleNav may revise this Agreement and the privacy policy at any time, with or without notice to you. You agree to visit <http://www.telenav.com> from time to time to review the then current version of this Agreement and of the privacy policy.

Customer Information

1. Safe and Lawful Use

You acknowledge that devoting attention to the TeleNav Software may pose a risk of injury or death to you and others in situations that otherwise require your undivided attention, and you therefore agree to comply with the following when using the TeleNav Software:

- (a) observe all traffic laws and otherwise drive safely;
- (b) use your own personal judgment while driving. If you feel that a route suggested by the TeleNav Software instructs you to perform an unsafe or illegal maneuver, places you in an unsafe situation, or directs you into an area that you consider to be unsafe, do not follow such instructions;
- (c) do not input destinations, or otherwise manipulate the TeleNav Software, unless your vehicle is stationary and parked;
- (d) do not use the TeleNav Software for any illegal, unauthorized, unintended, unsafe, hazardous, or unlawful purposes, or in any manner inconsistent with this Agreement;
- (e) arrange all GPS and wireless devices and cables necessary for use of the TeleNav Software in a secure manner in your vehicle so that they will not interfere with your driving and will not prevent the operation of any safety device (such as an airbag).

You agree to indemnify and hold TeleNav harmless against all claims resulting from any dangerous or otherwise inappropriate use of the TeleNav Software in any moving vehicle, including as a result of your failure to comply with the directions above.

2. Account Information

You agree: (a) when registering the TeleNav Software, to provide TeleNav with true, accurate, current, and complete information about yourself, and (b) to inform TeleNav promptly of any changes to such information, and to keep it true, accurate, current and complete.

3. Software License

- Subject to your compliance with the terms of this Agreement, TeleNav hereby grants to you a personal, non-exclusive, non-transferable license (except as expressly permitted below in connection with your permanent transfer of the TeleNav Software license), without the right to sublicense, to use the TeleNav Software (in object code form only) in order to access and use the TeleNav Software. This license shall terminate upon any termination or expiration of this Agreement. You agree that you will use the TeleNav Software only for your personal business or leisure purposes, and not to provide commercial navigation services to other parties.

3.1 License Limitations

- **(a)** reverse engineer, decompile, disassemble, translate, modify, alter or otherwise change the TeleNav Software or any part thereof; **(b)** attempt to derive the source code, audio library or structure of the TeleNav Software without the prior express written consent of TeleNav; **(c)** remove from the TeleNav Software, or alter, any of TeleNav's or its suppliers' trademarks, trade names, logos, patent or copyright notices, or other notices or markings; **(d)**

Customer Information

distribute, sublicense or otherwise transfer the TeleNav Software to others, except as part of your permanent transfer of the TeleNav Software; or **(e)** use the TeleNav Software in any manner that

- i. infringes the intellectual property or proprietary rights, rights of publicity or privacy or other rights of any party,
- ii. violates any law, statute, ordinance or regulation, including but not limited to laws and regulations related to spamming, privacy, consumer and child protection, obscenity or defamation, or
- iii. is harmful, threatening, abusive, harassing, tortuous, defamatory, vulgar, obscene, libelous, or otherwise objectionable; and (f) lease, rent out, or otherwise permit unauthorized access by third parties to the TeleNav Software without advanced written permission of TeleNav.

4. Disclaimers

- To the fullest extent permissible pursuant to applicable law, in no event will TeleNav, its licensors and suppliers, or agents or employees of any of the foregoing, be liable for any decision made or action taken by you or anyone else in reliance on the information provided by the TeleNav Software. TeleNav also does not warrant the accuracy of the map or other data used for the TeleNav Software. Such data may not always reflect reality due to, among other things, road closures, construction, weather, new roads and other changing conditions. You are responsible for the entire risk arising out of your use of the TeleNav Software. For example but without limitation, you agree not to rely on the TeleNav Software for critical navigation in areas where the well-being or survival of you or others

is dependent on the accuracy of navigation, as the maps or functionality of the TeleNav Software are not intended to support such high risk applications, especially in more remote geographical areas.

- TELENAV EXPRESSLY DISCLAIMS AND EXCLUDES ALL WARRANTIES IN CONNECTION WITH THE TELENAV SOFTWARE, WHETHER STATUTORY, EXPRESS OR IMPLIED, INCLUDING ALL WARRANTIES WHICH MAY ARISE FROM COURSE OF DEALING, CUSTOM OR TRADE AND INCLUDING, BUT NOT LIMITED TO, THE IMPLIED WARRANTIES OF MERCHANTABILITY, FITNESS FOR A PARTICULAR PURPOSE AND NON-INFRINGEMENT OF THIRD PARTY RIGHTS WITH RESPECT TO THE TELENAV SOFTWARE.
- Certain jurisdictions do not permit the disclaimer of certain warranties, so this limitation may not apply to you.

5. Limitation of Liability

- TO THE EXTENT PERMITTED UNDER APPLICABLE LAW, UNDER NO CIRCUMSTANCES SHALL TELENAV OR ITS LICENSORS AND SUPPLIERS BE LIABLE TO YOU OR TO ANY THIRD PARTY FOR ANY INDIRECT, INCIDENTAL, CONSEQUENTIAL, SPECIAL OR EXEMPLARY DAMAGES (INCLUDING IN EACH CASE, BUT NOT LIMITED TO, DAMAGES FOR THE INABILITY TO USE THE EQUIPMENT OR ACCESS DATA, LOSS OF DATA, LOSS OF BUSINESS, LOSS OF PROFITS, BUSINESS INTERRUPTION OR THE LIKE) ARISING OUT OF THE USE OF OR INABILITY TO USE THE TELENAV SOFTWARE, EVEN IF TELENAV HAS BEEN ADVISED OF THE POSSIBILITY OF SUCH DAMAGES. NOTWITHSTANDING ANY DAMAGES THAT YOU MIGHT INCUR FOR ANY

Customer Information

REASON WHATSOEVER (INCLUDING, WITHOUT LIMITATION, ALL DAMAGES REFERENCED HEREIN AND ALL DIRECT OR GENERAL DAMAGES IN CONTRACT, TORT (INCLUDING NEGLIGENCE) OR OTHERWISE), THE ENTIRE LIABILITY OF TELENAV AND OF ALL OF TELENAV'S SUPPLIERS SHALL BE LIMITED TO THE AMOUNT ACTUALLY PAID BY YOU FOR THE TELENAV SOFTWARE. SOME STATES AND/OR JURISDICTIONS DO NOT ALLOW THE EXCLUSION OR LIMITATION OF INCIDENTAL OR CONSEQUENTIAL DAMAGES, SO THE ABOVE LIMITATIONS OR EXCLUSIONS MAY NOT APPLY TO YOU.

6. Arbitration and Governing Law

- You agree that any dispute, claim or controversy arising out of or relating to this Agreement or the TeleNav Software shall be settled by independent arbitration involving a neutral arbitrator and administered by the American Arbitration Association in the County of Santa Clara, California. The arbitrator shall apply the Commercial Arbitration Rules of the American Arbitration Association, and the judgment upon the award rendered by the arbitrator may be entered by any court having jurisdiction. Note that there is no judge or jury in an arbitration proceeding and the decision of the arbitrator shall be binding upon both parties. You expressly agree to waive your right to a jury trial. This Agreement and performance hereunder will be governed by and construed in accordance with the laws of the State of California, without giving effect to its conflict of law provisions. To the extent judicial action is necessary in connection with the binding arbitration, both TeleNav and you agree to submit

to the exclusive jurisdiction of the courts of the County of Santa Clara, California. The United Nations Convention on Contracts for the International Sale of Goods shall not apply.

7. Assignment

- You may not resell, assign, or transfer this Agreement or any of your rights or obligations, except in totality, in connection with your permanent transfer of the TeleNav Software, and expressly conditioned upon the new user of the TeleNav Software agreeing to be bound by the terms and conditions of this Agreement. Any such sale, assignment or transfer that is not expressly permitted under this paragraph will result in immediate termination of this Agreement, without liability to TeleNav, in which case you and all other parties shall immediately cease all use of the TeleNav Software. Notwithstanding the foregoing, TeleNav may assign this Agreement to any other party at any time without notice, provided the assignee remains bound by this Agreement.

8. Miscellaneous

8.1

This Agreement constitutes the entire agreement between TeleNav and you with respect to the subject matter hereof.

8.2

Except for the limited licenses expressly granted in this Agreement, TeleNav retains all right, title and interest in and to the TeleNav Software, including without limitation all related intellectual property rights. No licenses or other rights which are not expressly granted in this Agreement are intended to, or shall be, granted or

Customer Information

conferred by implication, statute, inducement, estoppel or otherwise, and TeleNav and its suppliers and licensors hereby reserve all of their respective rights other than the licenses explicitly granted in this Agreement.

8.3

By using the TeleNav Software, you consent to receive from TeleNav all communications, including notices, agreements, legally required disclosures or other information in connection with the TeleNav Software (collectively, "Notices") electronically. TeleNav may provide such Notices by posting them on TeleNav's Website or by downloading such Notices to your wireless device. If you desire to withdraw your consent to receive Notices electronically, you must discontinue your use of the TeleNav Software.

8.4

TeleNav's or your failure to require performance of any provision shall not affect that party's right to require performance at any time thereafter, nor shall a waiver of any breach or default of this Agreement constitute a waiver of any subsequent breach or default or a waiver of the provision itself.

8.5

If any provision herein is held unenforceable, then such provision will be modified to reflect the intention of the parties, and the remaining provisions of this Agreement will remain in full force and effect.

8.6

The headings in this Agreement are for convenience of reference only, will not be deemed to be a part of this Agreement, and will not be referred to in connection with the construction or interpretation of this Agreement. As used in this Agreement, the words "include" and "including" and variations thereof, will not be deemed to be terms of limitation, but rather will be deemed to be followed by the words "without limitation".

9. Other Vendors Terms and Conditions

- The Telenav Software utilizes map and other data licensed to Telenav by third party vendors for the benefit of you and other end users. This Agreement includes end-user terms applicable to these companies (included at the end of this Agreement), and thus your use of the Telenav Software is also subject to such terms. You agree to comply with the following additional terms and conditions, which are applicable to Telenav's third party vendor licensors.

9.1 End User Terms Required by HERE North America, LLC

The data ("Data") is provided for your personal, internal use only and not for resale. It is protected by copyright, and is subject to the following terms and conditions which are agreed to by you, on the one hand, and Telenav ("Telenav") and its licensors (including their licensors and suppliers) on the other hand.

© 2013 HERE. All rights reserved.

The Data for areas of Canada includes information taken with permission from Canadian authorities, including: © Her Majesty the Queen in Right of Canada, © Queen's Printer for Ontario, © Canada Post Corporation, GeoBase®, © Department of Natural Resources Canada.

Customer Information

HERE holds a non-exclusive license from the United States Postal Service® to publish and sell ZIP+4® information.

©United States Postal Service® 2014. Prices are not established, controlled or approved by the United States Postal Service®. The following trademarks and registrations are owned by the USPS: United States Postal Service, USPS, and ZIP+4

The Data for Mexico includes certain data from Instituto Nacional de Estadística y Geografía.

9.2 End User Terms Required by NAV2 (Shanghai) Co., Ltd

The data (“Data”) is provided for your personal, internal use only and not for resale. It is protected by copyright, and is subject to the following terms and conditions which are agreed to by you, on the one hand, and NAV2 (Shanghai) Co., Ltd (“NAV2”) and its licensors (including their licensors and suppliers) on the other hand. 20xx. All rights reserved

Terms and Conditions

Permitted Use. You agree to use this Data together with the Telenav Software solely for the internal business and personal purposes for which you were licensed, and not for service bureau, time-sharing or other similar purposes. Accordingly, but subject to the restrictions set forth in the following paragraphs, you agree not to otherwise reproduce, copy, modify, decompile, disassemble, create any derivative works of, or reverse engineer any portion of this Data, and may not transfer or distribute it in any form, for any purpose, except to the extent permitted by mandatory laws.

Restrictions. Except where you have been specifically licensed to do so by Telenav, and without limiting the preceding paragraph, you may not use this Data (a) with any products, systems, or applications installed or otherwise connected to or in communication with vehicles, capable of vehicle navigation, positioning, dispatch, real time route guidance, fleet management or similar applications; or (b) with or in communication with any positioning devices or any mobile or wireless-connected electronic or computer devices, including without limitation cellular phones, palmtop and handheld computers, pagers, and personal digital assistants or PDAs.

Warning. The Data may contain inaccurate or incomplete information due to the passage of time, changing circumstances, sources used and the nature of collecting comprehensive geographic data, any of which may lead to incorrect results.

No Warranty. This Data is provided to you “as is,” and you agree to use it at your own risk. Telenav and its licensors (and their licensors and suppliers) make no guarantees, representations or warranties of any kind, express or implied, arising by law or otherwise, including but not limited to, content, quality, accuracy, completeness, effectiveness, reliability, fitness for a particular purpose, usefulness, use or results to be obtained from this Data, or that the Data or server will be uninterrupted or error-free.

Disclaimer of Warranty: TELENAV AND ITS LICENSORS (INCLUDING THEIR LICENSORS AND SUPPLIERS) DISCLAIM ANY WARRANTIES, EXPRESS OR IMPLIED, OF QUALITY, PERFORMANCE, MERCHANTABILITY, FITNESS FOR A

Customer Information

PARTICULAR PURPOSE OR NON-INFRINGEMENT. Some States, Territories and Countries do not allow certain warranty exclusions, so to that extent the above exclusion may not apply to you.

Disclaimer of Liability: TELENAV AND ITS LICENSORS (INCLUDING THEIR LICENSORS AND SUPPLIERS) SHALL NOT BE LIABLE TO YOU: IN RESPECT OF ANY CLAIM, DEMAND OR ACTION, IRRESPECTIVE OF THE NATURE OF THE CAUSE OF THE CLAIM, DEMAND OR ACTION ALLEGING ANY LOSS, INJURY OR DAMAGES, DIRECT OR INDIRECT, WHICH MAY RESULT FROM THE USE OR POSSESSION OF THE INFORMATION; OR FOR ANY LOSS OF PROFIT, REVENUE, CONTRACTS OR SAVINGS, OR ANY OTHER DIRECT, INDIRECT, INCIDENTAL, SPECIAL OR CONSEQUENTIAL DAMAGES ARISING OUT OF YOUR USE OF OR INABILITY TO USE THIS INFORMATION, ANY DEFECT IN THE INFORMATION, OR THE BREACH OF THESE TERMS OR CONDITIONS, WHETHER IN AN ACTION IN CONTRACT OR TORT OR BASED ON A WARRANTY, EVEN IF TELENAV OR ITS LICENSORS HAVE BEEN ADVISED OF THE POSSIBILITY OF SUCH DAMAGES. Some States, Territories and Countries do not allow certain liability exclusions or damages limitations, so to that extent the above may not apply to you.

Export Control. You shall not export from anywhere any part of the Data or any direct product thereof except in compliance with, and with all licenses and approvals required under, applicable export laws, rules and regulations, including but not limited to the laws, rules and regulations administered by the Office of Foreign Assets Control of the U.S. Department of Commerce and the Bureau of Industry and Security of the U.S. Department of Commerce. To the extent that any such

export laws, rules or regulations prohibit HERE from complying with any of its obligations hereunder to deliver or distribute Data, such failure shall be excused and shall not constitute a breach of this Agreement.

Entire Agreement. These terms and conditions constitute the entire agreement between Telenav (and its licensors, including their licensors and suppliers) and you pertaining to the subject matter hereof, and supersedes in their entirety any and all written or oral agreements previously existing between us with respect to such subject matter.

Governing Law. The above terms and conditions shall be governed by the laws of the State of Illinois [insert "Netherlands" where European HERE Data is used], without giving effect to (i) its conflict of laws provisions, or (ii) the United Nations Convention for Contracts for the International Sale of Goods, which is explicitly excluded. You agree to submit to the jurisdiction of the State of Illinois [insert "The Netherlands" where European HERE Data is used] for any and all disputes, claims and actions arising from or in connection with the Data provided to you hereunder.

Government End Users. If the Data is being acquired by or on behalf of the United States government or any other entity seeking or applying rights similar to those customarily claimed by the United States government, this Data is a "commercial item" as that term is defined at 48 C.F.R. ("FAR") 2.101, is licensed in accordance with these End-User Terms, and each copy of Data delivered or otherwise furnished shall be marked and embedded as appropriate with the following "Notice of Use," and shall be treated in accordance with such Notice:

Customer Information

NOTICE OF USE

CONTRACTOR (MANUFACTURER/
SUPPLIER) NAME: HERE

CONTRACTOR (MANUFACTURER/
SUPPLIER) ADDRESS: c/o Nokia, 425
West Randolph Street, Chicago, Illinois
60606

This Data is a commercial item as
defined in FAR 2.101 and is subject to
these End-User Terms under which this
Data was provided.

© 1987 – 2014 HERE – All rights reserved.

If the Contracting Officer, federal government agency, or any federal official refuses to use the legend provided herein, the Contracting Officer, federal government agency, or any federal official must notify HERE prior to seeking additional or alternative rights in the Data.

I. US/Canada Territory

A. United States Data. The End-User Terms for any Application containing Data for the United States shall contain the following notices:

“HERE holds a non-exclusive license from the United States Postal Service® to publish and sell ZIP+4® information.”

“©United States Postal Service® 20XX. Prices are not established, controlled or approved by the United States Postal Service®. The following trademarks and registrations are owned by the USPS: United States Postal Service, USPS, and ZIP+4.”

B. Canada Data. The following provisions apply to the Data for Canada, which may include or reflect data from third party licensors (“Third Party Data”), including Her Majesty the Queen in Right of Canada (“Her Majesty”), Canada Post Corporation (“Canada Post”) and the Department of Natural Resources of Canada (“NRCan”):

1. Disclaimer and Limitation: Client agrees that its use of the Third Party Data is subject to the following provisions:

a. Disclaimer: The Third Party Data is licensed on an “as is” basis. The licensors of such data, including Her Majesty, Canada Post and NRCan, make no guarantees, representations or warranties respecting such data, either express or implied, arising by law or otherwise, including but not limited to, effectiveness, completeness, accuracy or fitness for a particular purpose.

b. Limitation on Liability: The Third Party Data licensors, including Her Majesty, Canada Post and NRCan, shall not be liable: (i) in respect of any claim, demand or action, irrespective of the nature of the cause of the claim, demand or action alleging any loss, injury or damages, direct or indirect, which may result from the use or possession of such Data; or (ii) in any way for loss of revenues or contracts, or any other consequential loss of any kind resulting from any defect in the Data.

Customer Information

2. Copyright Notice: In connection with each copy of all or any portion of the Data for the Territory of Canada, Client shall affix in a conspicuous manner the following copyright notice on at least one of: (i) the label for the storage media of the copy; (ii) the packaging for the copy; or (iii) other materials packaged with the copy, such as user manuals or end user license agreements: "This data includes information taken with permission from Canadian authorities, including © Her Majesty the Queen in Right of Canada, © Queen's Printer for Ontario, © Canada Post Corporation, GeoBase®, © The Department of Natural Resources Canada. All rights reserved!"

3. End-User Terms: Except as otherwise agreed by the parties, in connection with the provision of any portion of the Data for the Territory of Canada to End-Users as may be authorized under the Agreement, Client shall provide such End-Users, in a reasonably conspicuous manner, with terms (set forth with other end user terms required to be provided under the Agreement, or as otherwise may be provided, by Client) which shall include the following provisions on behalf of the Third Party Data licensors, including Her Majesty, Canada Post and NRCan:

The Data may include or reflect data of licensors, including Her Majesty the Queen in the Right of Canada ("Her Majesty"), Canada Post Corporation ("Canada Post") and the Department of Natural Resources Canada ("NRCan"). Such data is licensed on an "as is" basis. The licensors, including Her Majesty, Canada Post and NRCan, make no guarantees, representations or warranties respecting such data,

either express or implied, arising by law or otherwise, including but not limited to, effectiveness, completeness, accuracy or fitness for a particular purpose. The licensors, including Her Majesty, Canada Post and NRCan, shall not be liable in respect of any claim, demand or action, irrespective of the nature of the cause of the claim, demand or action alleging any loss, injury or damages, direct or indirect, which may result from the use or possession of the data or the Data. The licensors, including Her Majesty, Canada Post and NRCan, shall not be liable in any way for loss of revenues or contracts, or any other consequential loss of any kind resulting from any defect in the data or the Data.

End User shall indemnify and save harmless the licensors, including Her Majesty, Canada Post and NRCan, and their officers, employees and agents from and against any claim, demand or action, irrespective of the nature of the cause of the claim, demand or action, alleging loss, costs, expenses, damages or injuries (including injuries resulting in death) arising out of the use or possession of the data or the Data.

4. Additional Provisions: The terms contained in this Section are in addition to all of the rights and obligations of the parties under the Agreement. To the extent that any of the provisions of this Section are inconsistent with, or conflict with, any other provisions of the Agreement, the provisions of this Section shall prevail.

Customer Information

II. Mexico. The following provision applies to the Data for Mexico, which includes certain data from the Instituto Nacional de Estadística y Geografía (“INEGI”):

A. Any and all copies of the Data and/or packaging containing Data for Mexico shall contain the following notice: “Fuente: INEGI (Instituto Nacional de Estadística y Geografía)”

III. Latin America Territory

A. Third Party Notices. Any and all copies of the Data and/or packaging relating thereto shall include the respective Third Party Notices set forth below and used as described below corresponding to the Territory (or portion thereof) included in such copy:

Territory Notice

Argentina IGN “INSTITUTO GEOGRAFICO NACIONAL ARGENTINO”

Ecuador “INSTITUTO GEOGRAFICO MILITAR DEL ECUADOR AUTORIZACION N° IGM-2011-01- PCO-01 DEL 25 DE ENERO DE 2011”
“source: © IGN 2009 - BD TOPO ®”

Guadeloupe, French Guiana and Martinique Mexico “Fuente: INEGI (Instituto Nacional de Estadística y Geografía)”

IV. Middle East Territory

A. Third Party Notices. Any and all copies of the Data and/or packaging relating thereto shall include the respective Third Party Notices set forth below and used as described below corresponding to the Territory (or portion thereof) included in such copy:

Country Notice

Jordan “© Royal Jordanian Geographic Centre”. The foregoing notice requirement for Jordan Data is a material term of the Agreement. If Client or any of its permitted sublicensees (if any) fail to meet such requirement, HERE shall have the right to terminate Client’s license with respect to the Jordan Data.

B. Jordan Data. Client and its permitted sublicensees (if any) are restricted from licensing and/or otherwise distributing HERE’s database for the country of Jordan (“Jordan Data”) for use in Enterprise Applications to (i) non-Jordanian entities for use of the Jordan Data solely in Jordan or (ii) Jordan-based customers. In addition, Client, its permitted sublicensees (if any) and End-Users are restricted from using the Jordan Data in Enterprise Applications if such party is (i) a non-Jordanian entity using the Jordan Data solely in Jordan or (ii) a Jordan-based customer. For purposes of the foregoing, “Enterprise Applications” shall mean Geomarketing applications, GIS applications, mobile business asset management applications, call center applications, telematics applications, public organization Internet applications or for providing geocoding services.

Customer Information

V. Europe Territory

A. Use of Certain Traffic Codes in Europe

1. General Restrictions Applicable to Traffic Codes. Client acknowledges and agrees that in certain countries of the Europe Territory, Client will need to obtain rights directly from third party RDS-TMC code providers to receive and use the Traffic Codes in the Data and to deliver to End-Users Transactions in any way derived from or based on such Traffic Codes. For such countries, HERE shall deliver the Data incorporating Traffic Codes to Client only after receiving certification from Client of its having obtained such rights.

2. Display of Third Party Rights Legends for Belgium. Client shall, for each Transaction that uses Traffic Codes for Belgium, provide the following notice to the End-User: "Traffic Codes for Belgium are provided by the Ministerie van de Vlaamse Gemeenschap and the Ministère de l'Équipement et des Transports."

B. Paper Maps. With respect to any license granted to Client relating to making, selling or distributing paper maps (i.e., a map fixed on a paper or paper-like medium): (a) such license with respect to Data for the Territory of Great Britain is conditioned on Client's entering into and complying with a separate written agreement with the Ordnance Survey ("OS") to create and sell paper maps, Client's paying to the OS any and all applicable paper map royalties, and Client's complying with the OS copyright notice requirements; (b) such license for selling or otherwise distributing for charge with respect to Data for the Territory of Czech Republic

is conditioned on Client's obtaining prior written consent from Kartografie a.s.; (c) such license for selling or distributing with respect to Data for the Territory of Switzerland is conditioned on Client's obtaining a permit from Bundesamt für Landestopografie of Switzerland; (d) Client is restricted from using Data for the Territory of France to create paper maps with a scale between 1:5,000 and 1:250,000; and (e) Client is restricted from using any Data to create, sell or distribute paper maps that are the same or substantially similar, in terms of data content and specific use of color, symbols and scale, to paper maps published by the European national mapping agencies, including without limitation, Landvermessungämter of Germany, Topografische Dienst of the Netherlands, Nationaal Geografisch Instituut of Belgium, Bundesamt für Landestopografie of Switzerland, Bundesamt für Eich-und Vermessungswesen of Austria, and the National Land Survey of Sweden.

C. OS Enforcement. Without limiting Section IV(B) above, with respect to Data for the Territory of Great Britain, Client acknowledges and agrees that the Ordnance Survey ("OS") may bring a direct action against Client to enforce compliance with the OS copyright notice (see Section IV(D) below) and paper map requirements (see Section IV(B) above) contained in this Agreement.

D. Third Party Notices. Any and all copies of the Data and/or packaging relating thereto shall include the respective Third Party Notices set forth below and used as described below corresponding to the Territory (or portion thereof) included in such copy:

Country(ies) Notice

Customer Information

Austria “© Bundesamt für Eich- und Vermessungswesen”

Croatia
Cyprus,
Estonia,
Latvia,
Lithuania,
Moldova,
Poland,
Slovenia
and/or
Ukraine

“© EuroGeographics”

France “source: © IGN 2009 – BD TOPO ®”

Germany “Die Grundlagendaten wurden mit Genehmigung der zuständigen Behörden entnommen”

Great Britain “Contains Ordnance Survey data © Crown copyright and database right 2010 Contains Royal Mail data © Royal Mail copyright and database right 2010”

Greece “Copyright Geomatics Ltd.”

Hungary “Copyright © 2003; Top-Map Ltd.”

Italy “La Banca Dati Italiana è stata prodotta usando quale riferimento anche cartografia numerica ed al tratto prodotta e fornita dalla Regione Toscana.”

Norway “Copyright © 2000; Norwegian Mapping Authority”

Portugal “Source: IgeoE – Portugal”

Spain “Información geográfica propiedad del CNIG”

Sweden “Based upon electronic data © National Land Survey Sweden.”

Switzerland “Topografische Grundlage: © Bundesamt für Landestopographie.

E. Respective Country Distribution. Client acknowledges that HERE has not received approvals to distribute map data for the following countries in such respective countries: Albania, Belarus, Kyrgyzstan, Moldova and Uzbekistan. HERE may update such list from time to time. The license rights granted to Client under this TL with respect to the Data for such countries are contingent upon Client’s compliance with all applicable laws and regulations, including, without limitation, any required licenses or approvals to distribute the Application incorporating such Data in such respective countries.

VI. Australia Territory

A. Third Party Notices. Any and all copies of the Data and/or packaging relating thereto shall include the respective Third Party Notices set forth below and used as described below corresponding to the Territory (or portion thereof) included in such copy:

Copyright. Based on data provided under license from PSMA Australia Limited (www.pasma.com.au).

Customer Information

Product incorporates data which is © 20XX Telstra Corporation Limited, GM Holden Limited, Intelomatics Australia Pty Ltd and Continental Pty Ltd.

B. Third Party Notices for Australia. In addition to the foregoing, the End-User Terms for any Application containing RDS-TMC Traffic Codes for Australia shall contain the following notice: “Product incorporates traffic location codes which is © 20XX Telstra Corporation Limited and its licensors.”

AT&T Vehicle Network Carrier Telematics Disclosure

END USER FOR PURPOSES OF THIS SECTION MEANS YOU AND YOUR HEIRS, EXECUTORS, LEGAL PERSONAL REPRESENTATIVES AND PERMITTED ASSIGNS. FOR PURPOSES OF THIS SECTION “UNDERLYING WIRELESS SERVICE CARRIER” INCLUDES ITS AFFILIATES AND CONTRACTORS AND THEIR RESPECTIVE OFFICERS, DIRECTORS, EMPLOYEES, SUCCESSORS AND ASSIGNS. END USER HAS NO CONTRACTUAL RELATIONSHIP WITH THE UNDERLYING WIRELESS SERVICE CARRIER AND END USER IS NOT A THIRD PARTY BENEFICIARY OF ANY AGREEMENT BETWEEN FORD AND UNDERLYING CARRIER. END USER UNDERSTANDS AND AGREES THAT THE UNDERLYING CARRIER HAS NO LEGAL, EQUITABLE, OR OTHER LIABILITY OF ANY KIND TO END USER. IN ANY EVENT, REGARDLESS OF THE FORM OF THE ACTION, WHETHER FOR BREACH OF CONTRACT, WARRANTY, NEGLIGENCE, STRICT LIABILITY IN TORT OR OTHERWISE, END USER'S EXCLUSIVE REMEDY FOR CLAIMS ARISING IN ANY WAY IN CONNECTION WITH THIS AGREEMENT, FOR ANY CAUSE WHATSOEVER, INCLUDING BUT NOT LIMITED TO ANY FAILURE OR

DISRUPTION OF SERVICE PROVIDED HEREUNDER, IS LIMITED TO PAYMENT OF DAMAGES IN AN AMOUNT NOT TO EXCEED THE AMOUNT PAID BY END USER FOR THE SERVICES DURING THE TWO-MONTH PERIOD PRECEDING THE DATE THE CLAIM AROSE.

(ii) END USER AGREES TO INDEMNIFY AND HOLD HARMLESS THE UNDERLYING WIRELESS SERVICE CARRIER AND ITS OFFICERS, EMPLOYEES, AND AGENTS AGAINST ANY AND ALL CLAIMS, INCLUDING WITHOUT LIMITATION CLAIMS FOR LIBEL, SLANDER, OR ANY PROPERTY DAMAGE, PERSONAL INJURY OR DEATH, ARISING IN ANY WAY, DIRECTLY OR INDIRECTLY, IN CONNECTION WITH THIS AGREEMENT OR THE USE, FAILURE TO USE, OR INABILITY TO USE THE DEVICE EXCEPT WHERE THE CLAIMS RESULT FROM THE UNDERLYING CARRIER'S GROSS NEGLIGENCE OR WILLFUL MISCONDUCT. THIS INDEMNITY WILL SURVIVE THE TERMINATION OF THE AGREEMENT.

(iii) END USER HAS NO PROPERTY RIGHT IN ANY NUMBER ASSIGNED TO THE DEVICE.

(iv) END USER UNDERSTANDS THAT FORD AND THE UNDERLYING CARRIER CANNOT GUARANTY THE SECURITY OF WIRELESS TRANSMISSIONS, AND WILL NOT BE LIABLE FOR ANY LACK OF SECURITY RELATING TO THE USE OF THE SERVICES

THE SERVICE IS FOR [END USER'S] USE ONLY AND END USER MAY NOT RESELL THE SERVICE TO ANY OTHER PARTY END USER UNDERSTANDS THAT THE UNDERLYING CARRIER DOES NOT GUARANTEE ANY END USER UNINTERRUPTED SERVICE OR COVERAGE. THE UNDERLYING CARRIER DOES NOT WARRANT THAT END USERS CAN OR WILL BE LOCATED USING THE SERVICE. THE UNDERLYING CARRIER

Customer Information

MAKES NO WARRANTY, EXPRESS OR IMPLIED, OF MERCHANTABILITY OR FITNESS FOR A PARTICULAR PURPOSE, SUITABILITY, OR PERFORMANCE REGARDING ANY SERVICES OR GOODS, AND IN NO EVENT SHALL AT&T BE LIABLE, WHETHER OR NOT DUE TO ITS OWN NEGLIGENCE, FOR ANY: (A) ACT OR OMISSION OF A THIRD PARTY; (B) MISTAKES, OMISSIONS, INTERRUPTIONS, ERRORS, FAILURES TO TRANSMIT, DELAYS, OR DEFECTS IN THE SERVICE PROVIDED BY OR THROUGH THE UNDERLYING CARRIER; (C) DAMAGE OR INJURY CAUSED BY SUSPENSION OR TERMINATION BY THE UNDERLYING CARRIER; OR (D) DAMAGE OR INJURY CAUSED BY A FAILURE OR DELAY IN CONNECTING A CALL TO ANY ENTITY, INCLUDING 911 OR ANY OTHER EMERGENCY SERVICE. TO THE FULL EXTENT ALLOWED BY LAW, THE END USER RELEASES, INDEMNIFIES AND HOLDS THE UNDERLYING CARRIER HARMLESS FROM AND AGAINST ANY AND ALL CLAIMS OF ANY PERSON OR ENTITY FOR DAMAGES OF ANY NATURE ARISING IN ANY WAY FROM OR RELATING TO, DIRECTLY OR INDIRECTLY, SERVICES PROVIDED BY THE UNDERLYING CARRIER OR ANY PERSON'S USE THEREOF, INCLUDING CLAIMS ARISING IN WHOLE OR IN PART FROM THE ALLEGED NEGLIGENCE OF THE UNDERLYING CARRIER.

VII. China Territory

Personal Use Only

You agree to use this Data together with [insert name of Client Application] for the solely personal, non-commercial purposes for which you were licensed, and not for service bureau, time-sharing or other similar purposes. Accordingly, but subject to the restrictions set forth in the following paragraphs, you may copy this Data only as necessary for your personal use to (i)

view it, and (ii) save it, provided that you do not remove any copyright notices that appear and do not modify the Data in any way. You agree not to otherwise reproduce, copy, modify, decompile, disassemble or reverse engineer any portion of this Data, and may not transfer or distribute it in any form, for any purpose, except to the extent permitted by mandatory laws.

Restrictions

Except where you have been specifically licensed to do so by NAV2, and without limiting the preceding paragraph, you may not (a) use this Data with any products, systems, or applications installed or otherwise connected to or in communication with vehicles, capable of vehicle navigation, positioning, dispatch, real time route guidance, fleet management or similar applications; or (b) with or in communication with any positioning devices or any mobile or wireless-connected electronic or computer devices, including without limitation cellular phones, palmtop and handheld computers, pagers, and personal digital assistants or PDAs. You agree to cease using this Data if you fail to comply with these terms and conditions.

Limited Warranty

NAV2 warrants that (a) the Data will perform substantially in accordance with the accompanying written materials for a period of ninety (90) days from the date of receipt, and (b) any support services provided by NAV2 shall be substantially as described in applicable written materials provided to you by NAV2, and NAV2's support engineers will make commercially reasonable efforts to solve any problem issues.

Customer Information

Customer Remedies

NAV2 and its suppliers' entire liability and your exclusive remedy shall be, at NAV2's sole discretion, either (a) return of the price paid, if any, or (b) repair or replacement of the Data that do not meet NAV2's Limited Warranty and that are returned to NAV2 with a copy of your receipt. This Limited Warranty is void if failure of the Data has resulted from accident, abuse, or misapplication. Any replacement Data will be warranted for the remainder of the original warranty period or thirty (30) days, whichever is longer. Neither these remedies nor any product support services offered by NAV2 are available without proof of purchase from an authorized international source.

No Other Warranty:

EXCEPT FOR THE LIMITED WARRANTY SET FORTH ABOVE AND TO THE EXTENT PERMITTED BY APPLICABLE LAW, NAV2 AND ITS LICENSORS (INCLUDING THEIR LICENSORS AND SUPPLIERS) DISCLAIM ANY WARRANTIES, EXPRESS OR IMPLIED, OF QUALITY, PERFORMANCE, MERCHANTABILITY, FITNESS FOR A PARTICULAR PURPOSE, OWNERSHIP OR NON-INFRINGEMENT. Certain warranty exclusions may not be permitted under applicable law, so to that extent the above exclusion may not apply to you.

Limited Liability:

TO THE EXTENT PERMITTED BY APPLICABLE LAW, NAV2 AND ITS LICENSORS (INCLUDING THEIR LICENSORS AND SUPPLIERS) SHALL NOT BE LIABLE TO YOU: IN RESPECT OF ANY CLAIM, DEMAND OR ACTION, IRRESPECTIVE OF THE NATURE OF THE CAUSE OF THE CLAIM, DEMAND OR ACTION ALLEGING ANY LOSS, INJURY OR DAMAGES, DIRECT OR INDIRECT, WHICH MAY RESULT FROM THE USE OR POSSESSION OF THE INFORMATION; OR

FOR ANY LOSS OF PROFIT, REVENUE, CONTRACTS OR SAVINGS, OR ANY OTHER DIRECT, INDIRECT, INCIDENTAL, SPECIAL OR CONSEQUENTIAL DAMAGES ARISING OUT OF YOUR USE OF OR INABILITY TO USE THIS INFORMATION, ANY DEFECT IN THE INFORMATION, OR THE BREACH OF THESE TERMS OR CONDITIONS, WHETHER IN AN ACTION IN CONTRACT OR TORT OR BASED ON A WARRANTY, EVEN IF NAV2 OR ITS LICENSORS HAVE BEEN ADVISED OF THE POSSIBILITY OF SUCH DAMAGES. UNDER NO CIRCUMSTANCES SHALL NAV2'S OR ITS SUPPLIERS' LIABILITY HEREUNDER EXCEED THE PRICE PAID. Certain liability exclusions may not be permitted under applicable law, so to that extent the above exclusion may not apply to you.

Export Control

You agree not to export to anywhere any part of the Data provided to you or any direct product thereof except in compliance with, and with all licenses and approvals required under, applicable export laws, rules and regulations.

IP Protection

The Data are owned by NAV2 or its suppliers and are protected by applicable copyright and other intellectual property law and treaties. The Data are provided solely on the basis of a license to use, not sale.

Entire Agreement

These terms and conditions constitute the entire agreement between NAV2 (and its licensors, including their licensors and suppliers) and you pertaining to the subject matter hereof, and supersedes in their entirety any and all written or oral agreements previously existing between us with respect to such subject matter.

Customer Information

Governing Law.

The above terms and conditions shall be governed by the laws of the People's Republic of China, without giving effect to (i) its conflict of laws provisions, or (ii) the United Nations Convention for Contracts for the International Sale of Goods, which is explicitly excluded. Any dispute arising from or in connection with the Data provided to you hereunder shall be submitted to the Shanghai International Economic and Trade Arbitration Commission for arbitration.

Gracenote® Copyright

CD and music-related data from Gracenote, Inc., copyright©

2000-2007 Gracenote. Gracenote Software, copyright © 2000-2007 Gracenote. This product and service may practice one or more of the following U.S. Patents 5,987,525; 6,061,680; 6,154,773; 6,161,132; 6,230,192; 6,230,207; 6,240,459; 6,330,593 and other patents issued or pending. Some services supplied under license from Open Globe, Inc. for U.S. Patent 6,304,523.

Gracenote and CDDB are registered trademarks of Gracenote. The Gracenote logo and logotype, and the "Powered by Gracenote™" logo are trademarks of Gracenote.

Gracenote® End User License Agreement (EULA)

This device contains software from Gracenote, Inc. of 2000 Powell Street Emeryville, California 94608 ("Gracenote").

The software from Gracenote (the "Gracenote Software") enables this device to do disc and music file identification and obtain music-related information, including name, artist, track, and title information ("Gracenote Data") from online servers

("Gracenote Servers"), and to perform other functions. You may use Gracenote Data only by means of the intended End User functions of this device. This device may contain content belonging to Gracenote's providers. If so, all of the restrictions set forth herein with respect to Gracenote Data shall also apply to such content and such content providers shall be entitled to all of the benefits and protections set forth herein that are available to Gracenote. You agree that you will use the content from Gracenote ("Gracenote Content"), Gracenote Data, the Gracenote Software, and Gracenote Servers for your own personal, non-commercial use only. You agree not to assign, copy, transfer or transmit the Gracenote Content, Gracenote Software or any Gracenote Data (except in a Tag associated with a music file) to any third party. YOU AGREE NOT TO USE OR EXPLOIT GRACENOTE CONTENT, GRACENOTE DATA, THE GRACENOTE SOFTWARE, OR GRACENOTE SERVERS, EXCEPT AS EXPRESSLY PERMITTED HEREIN.

You agree that your non-exclusive licenses to use the Gracenote Content, Gracenote Data, the Gracenote Software, and Gracenote Servers will terminate if you violate these restrictions. If your licenses terminate, you agree to cease any and all use of the Gracenote Content, Gracenote Data, the Gracenote Software, and Gracenote Servers.

Gracenote, respectively, reserve all rights in Gracenote Data, the Gracenote Software, and the Gracenote Servers and Gracenote Content, including all ownership rights. Under no circumstances will either Gracenote become liable for any payment to you for any information that you provide,

Customer Information

including any copyrighted material or music file information. You agree that Gracenote may enforce its respective rights, collectively or separately, under this agreement against you, directly in each company's own name.

Gracenote uses a unique identifier to track queries for statistical purposes. The purpose of a randomly assigned numeric identifier is to allow Gracenote to count queries without knowing anything about who you are. For more information, see the web page at www.gracenote.com for the Gracenote Privacy Policy.

THE GRACENOTE SOFTWARE, EACH ITEM OF GRACENOTE DATA AND THE GRACENOTE CONTENT ARE LICENSED TO YOU "AS IS". NEITHER GRACENOTE MAKES ANY REPRESENTATIONS OR WARRANTIES, EXPRESS OR IMPLIED, REGARDING THE ACCURACY OF ANY GRACENOTE DATA FROM THE GRACENOTE SERVERS OR GRACENOTE CONTENT. GRACENOTE COLLECTIVELY AND SEPARATELY RESERVE THE RIGHT TO DELETE DATA AND/OR CONTENT FROM THE COMPANIES' RESPECTIVE SERVERS OR, IN THE CASE OF GRACENOTE, CHANGE DATA CATEGORIES FOR ANY CAUSE THAT GRACENOTE DEEMS SUFFICIENT. NO WARRANTY IS MADE THAT EITHER GRACENOTE CONTENT OR THE GRACENOTE SOFTWARE OR GRACENOTE SERVERS ARE ERROR-FREE OR THAT THE FUNCTIONING OF THE GRACENOTE SOFTWARE OR GRACENOTE SERVERS WILL BE UNINTERRUPTED. GRACENOTE IS NOT OBLIGATED TO PROVIDE YOU WITH ANY ENHANCED OR ADDITIONAL DATA TYPES THAT GRACENOTE MAY CHOOSE TO PROVIDE IN THE FUTURE AND IS FREE TO DISCONTINUE ITS ONLINE SERVICES AT ANY TIME. GRACENOTE DISCLAIM ALL WARRANTIES EXPRESS OR IMPLIED, INCLUDING, BUT NOT LIMITED TO,

IMPLIED WARRANTIES OF MERCHANTABILITY, FITNESS FOR A PARTICULAR PURPOSE, TITLE, AND NON-INFRINGEMENT. NEITHER GRACENOTE WARRANTS THE RESULTS THAT WILL BE OBTAINED BY YOUR USE OF THE GRACENOTE SOFTWARE OR ANY GRACENOTE SERVER. IN NO CASE WILL GRACENOTE BE LIABLE FOR ANY CONSEQUENTIAL OR INCIDENTAL DAMAGES OR FOR ANY LOST PROFITS OR LOST REVENUES FOR ANY REASON WHATSOEVER. © Gracenote 2007.

Taiwan Territory

According to the "Technical Specifications for Low Power Radio Frequency Equipment" formulated by the National Communications and Communication Committee of the Executive Yuan: 3.8.2. For the low-power radio frequency equipment that has obtained the verification certificate, the company, firm or user shall not change the frequency, increase the power or change the characteristics and functions of the original design without authorization.

The use of low-power radio frequency equipment must not affect flight safety and interfere with legal communications: when the system detects interference, immediately stop using it until there is no interference.

The aforementioned legal communication refers to the wireless communication operated in accordance with the provisions of the Telecommunications Management Law. Low-power radio frequency equipment needs to endure the interference of legal communication or industrial, scientific and medical radio wave radiation electrical equipment.

Customer Information

SUNA TRAFFIC CHANNEL – TERMS AND CONDITIONS

By activating, using and/or accessing the SUNA Traffic Channel, SUNA Predictive or other content or material provided by Intelematics (together, **SUNA Products and/or Services**), you must accept certain terms and conditions. The following is a brief summary of the terms and conditions that apply to you. To view the full terms and conditions relevant to your use of the SUNA Products and/or Services, please consult:

Website
www.sunatrafic.com.au/termsandconditions/

1. Acceptance

By using SUNA Products and/or Services, you will be deemed to have accepted and agreed to be bound by the terms and conditions fully detailed at:

Website
www.sunatrafic.com.au/termsandconditions/

2. Intellectual Property

SUNA Products and/or Services are for your personal use. You may not record, or retransmit the content, nor use the content in association with any other traffic information or route guidance service or device not approved by Intelematics. You obtain no right of ownership in any Intellectual Property Rights (including copyright) in the data that is used to provide SUNA Products and/or Services.

3. Appropriate Use

SUNA Products and/or Services are intended as an aid to personal motoring and travel planning, and do not provide comprehensive or accurate information on all occasions. On occasions, you may experience additional delay as a result of using SUNA Products and/or Services. You acknowledge that it is not intended, or suitable, for use in applications where time of arrival or driving directions may impact the safety of the public or yourself.

4. Use of SUNA Products and Services while driving

You, and other authorized drivers of the vehicle in which SUNA Products and/or Services are available or installed and active, remain at all times responsible for observing all relevant laws and codes of safe driving. In particular, you agree to only actively operate SUNA Products and/or Services when the Vehicle is at a complete stop and it is safe to do so.

5. Service Continuity and Reception of the SUNA Traffic Channel

We will use reasonable endeavors to provide the SUNA Traffic Channel 24 hours a day, 365 days a year. The SUNA Traffic Channel may occasionally be unavailable for technical reasons or for planned maintenance. We will try to perform maintenance at times when congestion is light. We reserve the right to withdraw SUNA Products and/or Services at any time.

Also, we cannot assure the uninterrupted reception of the SUNA Traffic Channel RDS-TMC signal at any particular location.

6. Limitation of Liability

Neither Intelematics (nor its suppliers or the manufacturer of your device (the **"Suppliers"**)) shall be liable to you or to any third party for any damages either direct, indirect, incidental, consequential or otherwise arising out of the use of or inability to use SUNA Products and/or

Customer Information

Services even if Intelematics or a Supplier has been advised of the possibility of such damages. You also acknowledge that neither Intelematics nor any Supplier guarantees nor make any warranties that relate to the availability, accuracy or completeness of SUNA Products and/or Services, and to the extent which it is lawful to do so, both Intelematics and each Supplier excludes any warranties which might otherwise be implied by any State or Federal legislation in relation to SUNA Products and/or Services.

7. Please Note

Great care has been taken in preparing this manual. Constant product development may mean that some information is not entirely up-to-date. The information in this document is subject to change without notice.

EMISSION LAW



WARNING: Do not remove or alter the original equipment floor covering or insulation between it and the metal floor of the vehicle. The floor covering and insulation protect occupants of the vehicle from the engine and exhaust system heat and noise. On vehicles with no original equipment floor covering insulation, do not carry passengers in a manner that permits prolonged skin contact with the metal floor. Failure to follow these instructions may result in fire or personal injury.

U.S. federal laws and certain state laws prohibit removing or rendering inoperative emission control system components. Similar federal or provincial laws may apply in Canada. We do not approve of any vehicle modification without first determining applicable laws.



Tampering with emissions control systems including related sensors or the Diesel Exhaust Fluid system can result in reduced engine power and the illumination of the service engine soon light.

Tampering With a Noise Control System

Federal laws prohibit the following acts:

- Removal or rendering inoperative by any person other than for purposes of maintenance.
- Repair or replacement of any device or element of the design incorporated into a new vehicle for the purpose of noise control prior to its sale or delivery to the ultimate purchaser or while it is in use.
- The use of the vehicle after any person removes or renders inoperative any device or element of the design.

The U.S. Environmental Protection Agency may presume to constitute tampering as follows:

- Removal of hood blanket, fender apron absorbers, fender apron barriers, underbody noise shields or acoustically absorptive material.
- Tampering or rendering inoperative the engine speed governor, to allow engine speed to exceed manufacturer specifications.

If the engine does not start, runs rough, experiences a decrease in engine performance, experiences excess fuel consumption or produces excessive exhaust smoke, check for the following:

- A plugged or disconnected air inlet system hose.
- A plugged engine air filter element.
- Water in the fuel filter and water separator.

Customer Information

- A clogged fuel filter.
- Contaminated fuel.
- Air in the fuel system, due to loose connections.
- An open or pinched sensor hose.
- Incorrect engine oil level.
- Incorrect fuel for climatic conditions.
- Incorrect engine oil viscosity for climactic conditions.

Note: *Some vehicles have a lifetime fuel filter that is integrated with the fuel tank. Regular maintenance or replacement is not needed.*

Note: *If these checks do not help you correct the concern, have your vehicle checked as soon as possible.*

Noise Emissions Warranty, Prohibited Tampering Acts and Maintenance

On January 1, 1978, Federal regulation became effective governing the noise emission on trucks over 4,536 kg (10,000 lb) Gross Vehicle Weight Rating (GVWR). The preceding statements concerning prohibited tampering acts and maintenance, and the noise warranty found in the Warranty Guide, are applicable to complete chassis cabs over 4,536 kg (10,000 lb) GVWR.

EXPORT UNIQUE OPTIONS

For your particular global region, your vehicle may be equipped with features and options that are different from the features and options that are described in this Owner's Manual. A market unique supplement may be supplied that complements this book. By referring to the market unique supplement, if provided, you can properly identify those features, recommendations and specifications that are unique to your vehicle. This Owner's

Manual is written primarily for the U.S. and Canadian markets. Features or equipment listed as standard may be different on units built for export. **Refer to this Owner's Manual for all other required information and warnings.**

WARRANTY INFORMATION

The following warranties may apply to your vehicle:

- New vehicle limited warranties.
- Emissions warranties, if applicable. (Note: Fully-electric vehicles are not eligible for emissions warranties.)
- Other warranties, if applicable.

Detailed warranty information specific to your vehicle can be found in the Warranty Guide at www.owner.ford.com.

The following California Warranty Statement, required by California regulations, applies to vehicles certified to California emissions standards and registered in a state that requires California emissions warranty. If applicable, additional California Emissions Warranties can be found in the Warranty Guide at www.owner.ford.com.

CALIFORNIA EMISSION CONTROL WARRANTY STATEMENT

YOUR WARRANTY RIGHTS AND OBLIGATIONS

The California Air Resources Board and Ford Motor Company are pleased to explain the emission control system warranty on your (year) vehicle. In California, new motor vehicles must be designated, built and equipped to meet

Customer Information

the State's stringent anti-smog standards. Ford Motor Company must warrant the emission control system on your vehicle for the periods of time listed below provided there has been no abuse, neglect or improper maintenance of your vehicle.

Your emission control system may include parts such as the carburetor or fuel-injection system, the ignition system, catalytic converter and engine computer. Also included may be hoses, belts, connectors and other emission-related assemblies. Where a warrantable condition exists, Ford Motor Company will repair your vehicle at no cost to you including diagnosis, parts and labor.

MANUFACTURER'S WARRANTY COVERAGE:

(For 1990 and subsequent model passenger cars, light-duty trucks, and medium-duty vehicles.)

- For 3 years or 50,000 miles (whichever occurs first);

1) If your vehicle fails a Smog Check inspection, all necessary repairs and adjustments will be made by Ford Motor Company to ensure that your emission control system **PERFORMANCE WARRANTY**.

2) If any emission-related part on your vehicle is defective, the part will be repaired or replaced by Ford Motor Company. This is your short-term emission control system **DEFECTS WARRANTY**.

- For 7 years or 70,000 miles (whichever occurs first);

1) If an emission-related part listed in this warranty booklet specially noted with coverage for 7 years or 70,000 miles is defective, the part will be repaired or replaced by Ford Motor Company. This is your long-term emission control system **DEFECTS WARRANTY**.

OWNER'S WARRANTY RESPONSIBILITIES:

- As the vehicle owner, you are responsible for the performance of the required maintenance listed in your owner's manual. Ford Motor Company recommends that you retain all receipts covering maintenance on your vehicle, but Ford Motor Company cannot deny warranty solely for the lack of receipts or for your failure to ensure the performance of all scheduled maintenance.

- You are responsible for presenting your vehicle to a Ford or Lincoln dealer as soon as a problem exists. The warranty repairs should be completed in a reasonable amount of time, not to exceed 30 days.

- As the vehicle owner, you should also be aware that Ford Motor Company may deny you warranty coverage if your vehicle or a part has failed due to abuse, neglect, improper maintenance or unapproved modifications.

If you have any questions regarding your warranty rights and responsibilities, you should contact Ford Customer Service at 1-800-392-3673 or the California Air Resource Board at 4001 Iowa Avenue, Riverside, CA 92507.

New Vehicle Limited Warranty

Your vehicle comes with a New Vehicle Limited Warranty. The express warranties of the New Vehicle Limited Warranty are in substitution for and exclude all other liabilities of any kind whether arising under statute, in tort, by implication of law or otherwise including, to the full extent as may be allowed by law, liability for any other representations respecting the vehicle, statutory warranties or implied warranties or conditions as to its merchantability or fitness.

Customer Information

Download a free electronic copy or order one free printed copy of the most up-to-date Warranty Guide by visiting the Owner Manuals section of owner.ford.com (United States).

For Canada, visit ford.ca/warranty.

For Limo/Livery/Hearse vehicles: View and download your Warranty Guide by visiting the Warranty Information section of the Fleet website, fleet.ford.com/limo (United States only).

Appendices

ELECTROMAGNETIC COMPATIBILITY



WARNING: Do not place objects or mount equipment on or near the airbag cover, on the side of the front or rear seatbacks, or in areas that may come into contact with a deploying airbag. Failure to follow these instructions may increase the risk of personal injury in the event of a crash.



WARNING: Keep antenna and power cables at least 10 cm (4 in) from any electronic modules and airbags.

Note: We test and certify your vehicle to meet electromagnetic compatibility legislation. It is your responsibility to make sure that any equipment an authorized dealer installs on your vehicle complies with applicable local legislation and other requirements. Installation of some aftermarket electronic devices could degrade the performance of vehicle functions, which use radio frequency signals such as broadcast radio receiver, tire pressure monitoring system, push button start, **Bluetooth®** connectivity or satellite navigation.

Note: Any radio frequency transmitter equipment in your vehicle, such as, cellular telephones and amateur radio transmitters, must keep to the parameters in the following illustrations and table. We do not provide any other special provisions or conditions for installations or use.

Car

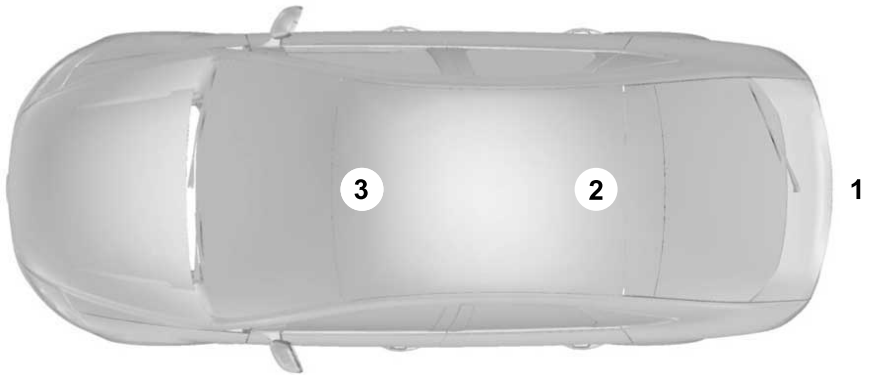

Appendices

Van



Truck

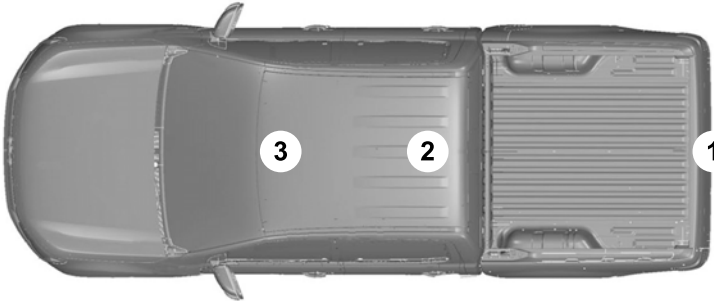

Appendices

Frequency Band MHz	Maximum Output Power Watt (Peak RMS)	Antenna Positions
1-30	50	1
50-54	50	2, 3
68-88	50	2, 3
142-176	50	2, 3
380-512	50	2, 3
806-870	10	2, 3

Index

1

12V Battery.....	470
12V Battery Precautions.....	470
Battery Management System	
Limitations.....	471
Changing the 12V Battery.....	471
How Does the Battery Management	
System Work.....	471
Recycling and Disposing of the 12V	
Battery.....	472
Resetting the Battery Sensor.....	472
What Is the Battery Management	
System.....	471
12V Battery – Troubleshooting.....	473
12V Battery – Information Messages.....	473
12V Battery – Warning Lamps.....	473

3

360 Degree Camera.....	289
360 Degree Camera Settings.....	291
360 Degree Camera Guide Lines.....	290
360 Degree Camera Precautions.....	289
360 Degree Camera Settings.....	291
Switching the 360 Degree Camera On and	
Off.....	291
Switching the 360 Degree Camera	
View.....	291

4

4WD	
See: Four-Wheel Drive.....	231

9

911 Assist.....	65
911 Assist Videos.....	66

A

A/C

See: Climate Control - Vehicles With:	
Automatic Temperature Control.....	138
See: Climate Control - Vehicles With: Manual	
Temperature Control.....	143
About This Publication.....	19

ABS

See: Brakes.....	251
Accessing Navigation.....	575
Accessing the Passive Key Backup	
Position.....	196
Accessing the Trip Computer - Vehicles	
With: 12 Inch Screen.....	134
Accessing the Trip Computer - Vehicles	
With: 4.2 Inch Screen.....	134
Accessories.....	581
Adaptive Cruise Control.....	295
Adaptive Cruise Control –	
Troubleshooting.....	308
Lane Centering.....	302
Lane Centering – Troubleshooting.....	305
Predictive Speed Assist.....	306
Predictive Speed Assist –	
Troubleshooting.....	308
Adaptive Cruise Control Automatic	
Cancellation.....	298
Adaptive Cruise Control Indicators.....	302
Adaptive Cruise Control	
Limitations.....	296
Adaptive Cruise Control	
Precautions.....	295
Adaptive Cruise Control –	
Troubleshooting.....	308
Adaptive Cruise Control – Information	
Messages.....	308
Adaptive Cruise Control Videos.....	309
Adaptive Front Lighting.....	117
How Does Adaptive Front Lighting	
Work.....	117
Adjustable Pedals.....	104
Adjusting the Exterior Mirrors.....	124
Adjusting the Headlamps.....	473
Adjusting the Instrument Panel Lighting	
Brightness.....	119
Adjusting the Integrated Trailer Brake	
Controller Mode.....	375
Adjusting the Map.....	575
Changing the Format of the Map.....	575
Zooming the Map In and Out.....	575
Adjusting the Pedals.....	104
Adjusting the Seatbelt Height.....	51
Adjusting the Seatbelt Length.....	52
Adjusting the Seatbelts During	
Pregnancy.....	51

Index

Adjusting the Sound Settings.....	549
Adjusting the Steering Wheel - Vehicles With: Manual Adjustable Steering Column.....	101
Adjusting the Steering Wheel - Vehicles With: Power Adjustable Steering Column.....	101
Adjusting the Volume.....	549
After Driving Your Vehicle	
Off-Road.....	416
Aid Mode.....	318
How Does Aid Mode Work.....	318
What Is Aid Mode.....	318
Airbag Precautions.....	57
Airbags.....	55
Air Conditioning	
See: Climate Control - Vehicles With: Automatic Temperature Control.....	138
See: Climate Control - Vehicles With: Manual Temperature Control.....	143
Air Conditioning System	
Refrigerant.....	141
Alarm	
See: Connecting a Trailer.....	362
Alert and Aid Mode.....	318
How Does Alert and Aid Mode Work.....	318
What Is Alert and Aid Mode.....	318
Alert Mode.....	317
How Does Alert Mode Work.....	318
What Is Alert Mode.....	317
Alexa Built-In.....	564
Alexa Built-In Requirements.....	564
Alexa Built-In Settings.....	564
AM/FM Radio.....	550
AM/FM Radio Limitations.....	550
Selecting a Radio Station.....	550
Ambient Lighting.....	119
Adjusting Ambient Lighting.....	119
Switching Ambient Lighting On and Off.....	119
Anti-Lock Braking System.....	251
Anti-Lock Braking System Limitations.....	251
Anti-Theft Alarm System.....	96
Arming the Anti-Theft Alarm System.....	96
Disarming the Anti-Theft Alarm System.....	96
How Does the Anti-Theft Alarm System Work.....	96
What Is the Anti-Theft Alarm System.....	96
What Is the Perimeter Alarm.....	96
Appendices.....	697
Applying the Electric Parking Brake.....	255
Applying the Electric Parking Brake in an Emergency.....	255
Approach Detection	
See: Switching Welcome Lighting On and Off.....	113
Audio System.....	548
AM/FM Radio.....	550
Audio System – Troubleshooting.....	554
Digital Radio.....	550
Satellite Radio.....	551
Audio System Precautions.....	548
Audio System – Troubleshooting.....	554
Audio System – Information Messages.....	554
Auto-Dimming Interior Mirror.....	123
Auto-Dimming Interior Mirror Limitations.....	123
What Is the Auto-Dimming Interior Mirror.....	123
Autolamps.....	110
Autolamp Settings.....	110
What Are Autolamps.....	110
Autolock.....	76
Autolock Requirements.....	76
What Is Autolock.....	76
Automatically Releasing the Electric Parking Brake.....	256
Automatic Crash Shutoff.....	427
Automatic Crash Shutoff Precautions.....	427
Re-Enabling Your Vehicle.....	427
What Is Automatic Crash Shutoff.....	427
Automatic Emergency Braking.....	342
Switching Automatic Emergency Braking On and Off.....	342
What Is Automatic Emergency Braking.....	342
Automatic Engine Stop.....	195
How Does Automatic Engine Stop Work.....	195
Overriding Automatic Engine Stop.....	196

Index

Switching Automatic Engine Stop On and Off.....	195
What Is Automatic Engine Stop.....	195
Automatic High Beam Control.....	114
Automatic High Beam Control Indicators.....	116
Automatic High Beam Control Limitations.....	115
Automatic High Beam Control Precautions.....	115
Automatic High Beam Control Requirements.....	115
How Does Automatic High Beam Control Work.....	114
Overriding Automatic High Beam Control.....	116
Switching Automatic High Beam Control On and Off.....	116
Automatic High Beam Control – Troubleshooting.....	116
Automatic High Beam Control – Information Messages.....	116
Automatic Locking Mode.....	50
Disengaging Automatic Locking Mode.....	51
Engaging Automatic Locking Mode.....	50
What Is Automatic Locking Mode.....	50
When to Use Automatic Locking Mode.....	50
Automatic Transmission Audible Warnings.....	229
Automatic Transmission.....	226
Automatic Transmission Positions.....	226
Automatic Transmission Fluid Capacity and Specification.....	229
Automatic Transmission Positions.....	226
Automatic Transmission Position Indicators.....	227
Automatic Transmission Precautions.....	226
Drive (D).....	227
Manual (M).....	227
Neutral (N).....	227
Park (P).....	226
Reverse (R).....	227
Shifting Your Vehicle Into Gear.....	226
Auto Mode.....	140
Switching Auto Mode On and Off.....	140
Switching Dual Mode On and Off.....	140
Autounlock.....	76
Autounlock Requirements.....	76
Switching Autounlock On and Off.....	76
What Is Autounlock.....	76
Autowipers.....	105
Adjusting the Sensitivity of the Rain Sensor.....	105
Autowipers Settings.....	105
What Are Autowipers.....	105
Auxiliary Switches.....	582

B

Basic Off-Road Driving Techniques.....	414
Battery Fuse Box.....	439
Accessing the Battery Fuse Box.....	439
Identifying the Fuses in the Battery Fuse Box.....	440
Locating the Battery Fuse Box.....	439
Blind Spot Assist.....	319
Blind Spot Assist Limitations.....	320
How Does Blind Spot Assist Work.....	319
What Is Blind Spot Assist.....	319
Blind Spot Assist with Trailer Coverage.....	320
Blind Spot Assist with Trailer Coverage Indicators.....	321
Blind Spot Assist with Trailer Coverage Limitations.....	321
How Does Blind Spot Assist with Trailer Coverage Work.....	320
What Is Blind Spot Assist with Trailer Coverage.....	320
Blind Spot Information System.....	326
Blind Spot Information System – Troubleshooting.....	329
Blind Spot Information System With Trailer Coverage.....	327
Blind Spot Information System Indicators.....	329
Blind Spot Information System Limitations.....	326
Blind Spot Information System Precautions.....	326
Blind Spot Information System Requirements.....	326

Index

Blind Spot Information System – Troubleshooting.....	329
Blind Spot Information System – Information Messages.....	329
Blind Spot Information System With Trailer Coverage.....	327
Blind Spot Information System With Trailer Coverage Limitations.....	328
Selecting a Trailer.....	329
Setting a Trailer Length.....	328
What Is Blind Spot Information System with Trailer Coverage.....	327
Bluetooth®.....	572
Bonnet Lock See: Opening and Closing the Hood.....	445
Booster Seats.....	45
Brake Fluid Specification.....	252
Brake Over Accelerator.....	251
Brake Precautions.....	251
Brakes.....	251
Anti-Lock Braking System.....	251
Brakes – Troubleshooting.....	252
Brakes – Troubleshooting.....	252
Brakes – Frequently Asked Questions.....	254
Brakes – Information Messages.....	253
Brakes – Warning Lamps.....	252
Breaking-In.....	418
C	
Calculating Payload.....	353
Calculating the Load Limit.....	354
Canceling the Set Speed.....	271
Catalytic Converter.....	225
Catalytic Converter – Troubleshooting.....	225
Catalytic Converter Precautions.....	225
Catalytic Converter – Troubleshooting.....	225
Catalytic Converter – Warning Lamps.....	225
Center Console.....	185
Opening the Center Console.....	185
Center Console Work Surface.....	180
Center Console Work Surface – Troubleshooting.....	181
Center Console Work Surface – Troubleshooting.....	181
Center Console Work Surface – Information Messages.....	181
Center Display.....	558
Center Display Overview.....	558
Changing a Flat Tire.....	530
Changing a Road Wheel.....	530
Changing the Fuel Filter - Diesel.....	467
Changing the Fuel Filter - Gasoline.....	467
Changing the Remote Control Battery - Vehicles With: Flip Key.....	69
Changing the Remote Control Battery - Vehicles With: Push Button Start.....	70
Charging a Device.....	169
Charging a Wireless Device.....	182
Checking the Brake Fluid.....	251
Checking the Seatbelts.....	54
Checking the Selective Catalytic Reduction System Status.....	221
Checking the Tire Pressures.....	510
Checking the Wiper Blades.....	106
Children and Airbags.....	62
Child Restraint Anchor Points.....	35
Locating the Child Restraint Lower Anchor Points.....	35
Locating the Child Restraint Top Tether Anchor Points.....	36
What Are the Child Restraint Anchor Points.....	35
Child Restraints.....	37
Child Restraint Position Information.....	37
Child Restraints Recommendation.....	38
Child Safety.....	34
Child Restraint Anchor Points.....	35
Child Restraints.....	37
Installing Child Restraints.....	38
Child Safety Locks - Crew Cab/ SuperCab.....	47
Child Safety Precautions.....	34
Cleaning Products.....	489
Cleaning the Exterior.....	490
Cleaning Camera Lenses and Sensors.....	492
Cleaning Chrome, Aluminium or Stainless Steel.....	490
Cleaning Headlamps and Rear Lamps.....	490

Index

Cleaning Stripes or Graphics.....	491	Connecting a Trailer.....	362
Cleaning the Engine Compartment.....	491	Connecting a Trailer –	
Cleaning the Exhaust.....	492	Troubleshooting.....	365
Cleaning the Exterior Precautions.....	490	Hitches.....	359
Cleaning the Underbody.....	492	Connecting a Trailer Precautions.....	359
Cleaning Wheels.....	490	Connecting a Trailer –	
Cleaning Windows and Wiper		Troubleshooting.....	365
Blades.....	490	Connecting a Trailer – Information	
Cleaning the Interior.....	493	Messages.....	365
Cleaning Carpets and Floor Mats.....	494	Connecting the Vehicle to a Mobile	
Cleaning Displays and Screens.....	493	Network.....	543
Cleaning Fabric.....	493	Connecting FordPass to the Modem.....	543
Cleaning Glass Roof Tracks.....	494	Enabling and Disabling the Modem.....	543
Cleaning Leather.....	493	What Is the Modem.....	543
Cleaning Plastic.....	493	Connecting the Vehicle to a Wi-Fi	
Cleaning Seatbelts.....	494	Network.....	543
Cleaning the Instrument Panel.....	493	Connecting Your Phone.....	566
Cleaning Vinyl.....	494	Contacting Us.....	17
Climate Control.....	138	Coolant.....	462
Auto Mode.....	140	Adding Coolant.....	462
Climate Control Hints.....	140	Changing the Coolant.....	463
Climate Control Videos.....	141	Checking the Coolant Level.....	462
Closing the Tailgate.....	85	Coolant – Information Messages.....	467
Closing the Tailgate From Inside Your		Coolant – Warning Lamps.....	466
Vehicle.....	85	Cooling System Capacity and	
Closing the Tailgate From Outside Your		Specification.....	464
Vehicle.....	86	Managing the Coolant Temperature.....	464
Closing the Tailgate Using the Remote		Crash and Breakdown	
Control.....	86	Information.....	423
Cold Weather Precautions - 6.7L		Automatic Crash Shutoff.....	427
Diesel.....	417	Fail-Safe Cooling.....	429
Cold Weather Precautions - 6.8L/		Jump Starting the Vehicle.....	424
7.3L.....	417	Post-Crash Alert System.....	426
Connected Navigation.....	575	Recovery Towing.....	428
Connected Vehicle.....	543	Crash Sensors and Airbag Indicator.....	63
Connected Vehicle –		Creating a Personal Profile.....	573
Troubleshooting.....	544	Cross Traffic Alert.....	334
Connecting the Vehicle to a Mobile		Cross Traffic Alert –	
Network.....	543	Troubleshooting.....	337
Connected Vehicle Data.....	29	Cross Traffic Alert Indicators.....	336
Connected Vehicle Limitations.....	543	Cross Traffic Alert Limitations.....	335
Connected Vehicle Requirements.....	543	Cross Traffic Alert Precautions.....	334
Connected Vehicle Settings.....	544	Cross Traffic Alert –	
Connected Vehicle –		Troubleshooting.....	337
Troubleshooting.....	544	Cross Traffic Alert – Information	
Connected Vehicle – Frequently Asked		Messages.....	337
Questions.....	544	Cruise Control.....	293
Connecting a Bluetooth® Device.....	572	Cruise Control Indicators.....	294

Index

Cup Holders.....	184
Cup Holder Precautions.....	184
Customer Information.....	594
Radio Frequency Certification Labels.....	597
Customizing the Instrument Cluster	
Display - Vehicles With: 12 Inch	
Screen.....	133
Customizing the Instrument Cluster	
Display - Vehicles With: 4.2 Inch	
Screen.....	133
D	
Data Privacy.....	27
Deleting a Personal Profile.....	574
Department of Transportation Uniform	
Tire Quality Grades.....	498
Diesel Engine Exhaust Brake.....	258
Diesel Engine Exhaust Brake -	
Troubleshooting.....	259
Diesel Engine Exhaust Brake	
Gauge.....	259
Diesel Engine Exhaust Brake	
Indicators.....	259
Diesel Engine Exhaust Brake -	
Precautions.....	258
Diesel Engine Exhaust Brake -	
Troubleshooting.....	259
Diesel Engine Exhaust Brake - Warning	
Lamps.....	259
Diesel Exhaust Fluid Capacity and	
Specification.....	221
Diesel Exhaust Fluid Gauge.....	131
Diesel Particulate Filter.....	212
Diesel Particulate Filter Manual	
Regeneration.....	213
Diesel Particulate Filter -	
Troubleshooting.....	215
Diesel Particulate Filter Manual	
Regeneration.....	213
Diesel Particulate Filter Manual	
Regeneration Limitations.....	214
Diesel Particulate Filter Manual	
Regeneration Precautions.....	213
Diesel Particulate Filter Manual	
Regeneration Requirements.....	213
Starting Diesel Particulate Filter Manual	
Regeneration.....	214
What Is Diesel Particulate Filter Manual	
Regeneration.....	213
Diesel Particulate Filter	
Precautions.....	212
Diesel Particulate Filter	
Requirements.....	213
Diesel Particulate Filter -	
Troubleshooting.....	215
Diesel Particulate Filter - Information	
Messages.....	215
Diesel Particulate Filter - Warning	
Lamps.....	215
Digital Radio.....	550
Digital Radio Indicators.....	551
Digital Radio Limitations.....	551
How Does Digital Radio Work.....	550
Switching Digital Radio Reception On and	
Off.....	551
What Is Digital Radio.....	550
Dinghy Tow	
See: Recreationally Towing Your Vehicle -	
4x2.....	433
See: Recreationally Towing Your Vehicle -	
4x4.....	431
Directing the Flow of Air.....	140
Disposing of Airbags.....	64
Distance Alert.....	342
Adjusting the Sensitivity of Distance	
Alert.....	342
What Is Distance Alert.....	342
Distance Indication.....	341
Distance Indication Indicator.....	342
What Is Distance Indication.....	341
Doors and Locks Audible Warnings.....	76
Doors and Locks.....	75
Autolock.....	76
Autounlock.....	76
Doors and Locks - Troubleshooting.....	77
Mislock.....	76
Operating the Doors From Inside Your	
Vehicle.....	75
Operating the Doors From Outside Your	
Vehicle.....	75
Doors and Locks - Troubleshooting.....	77
Doors and Locks - Frequently Asked	
Questions.....	78
Doors and Locks - Information	
Messages.....	77

Index

Doors and Locks – Warning Lamps.....	77
Draining the Fuel Filter Water Trap - Diesel.....	459
Drive Belt Routing Overview - 6.7L Diesel, Vehicles With: 110-120V 2kW Pickup Bed Power Outlet/Dual Generators.....	467
Drive Belt Routing Overview - 6.7L Diesel, Vehicles With: Dual Generators.....	468
Drive Belt Routing Overview - 6.7L Diesel, Vehicles With: Single Generator.....	468
Drive Belt Routing Overview - 6.8L, Gasoline, Vehicles With: Dual Generators.....	468
Drive Belt Routing Overview - 6.8L, Gasoline, Vehicles With: Single Generator.....	469
Drive Belt Routing Overview - 7.3L, Gasoline, Vehicles With: Dual Generators.....	469
Drive Belt Routing Overview - 7.3L, Gasoline, Vehicles With: Single Generator.....	470
Drive Mode Control.....	310
Drive Mode Control – Troubleshooting.....	313
Drive Modes.....	310
Drive Mode Control – Troubleshooting.....	313
Drive Mode Control – Frequently Asked Questions.....	315
Drive Mode Control – Information Messages.....	314
Drive Mode Control – Warning Lamps.....	313
Drive Modes.....	310
Eco.....	310
Normal.....	311
Off-Road.....	311
Rock Crawl.....	312
Slippery.....	312
Tow/Haul.....	313
Trail.....	313
Driver Alert.....	349
Driver Alert – Troubleshooting.....	350
Driver Alert Limitations.....	349
Driver Alert Precautions.....	349
Driver Alert – Troubleshooting.....	350
Driver Alert – Information Messages.....	350
Driver Assistance Menu.....	560
Driving Economically.....	418
Driving Hints.....	417
Driving on Snow and Ice.....	417
Driving Through Mud and Water.....	418
Driving Through Water Limitations.....	415
Drowsiness Monitor See: Driver Alert.....	349
E	
Easy Entry and Exit.....	81
Electric Parking Brake Audible Warning.....	256
Electric Parking Brake.....	255
Electric Parking Brake – Troubleshooting.....	256
Electric Parking Brake – Troubleshooting.....	256
Electric Parking Brake – Information Messages.....	257
Electric Parking Brake – Warning Lamps.....	256
Electromagnetic Compatibility.....	697
Electronic Locking Differential.....	247
Electronic Locking Differential – Troubleshooting.....	250
Electronic Locking Differential Indicators.....	249
Electronic Locking Differential Precautions.....	247
Electronic Locking Differential – Troubleshooting.....	250
Electronic Locking Differential – Information Messages.....	250
Emergency Call Limitations.....	66
Emergency Call Requirements.....	65
Emergency Call System Data.....	30
Emergency Towing.....	433
Emission Law.....	693
Enabling Apps on a Mobile Device.....	570
Enabling or Disabling Personal Profiles.....	573
End User License Agreement.....	668
Engine Air Filter.....	457
Changing the Engine Air Filter.....	457

Index

Engine Air Filter – Information	
Messages.....	459
Resetting the Air Filter Reminder.....	458
Engine Block Heater.....	192
Engine Block Heater Precautions.....	192
How Does the Engine Block Heater Work.....	193
Using the Engine Block Heater.....	193
Engine Coolant Temperature Gauge.....	131
Engine Oil.....	449
Adding Engine Oil.....	450
Checking the Engine Oil Level.....	449
Engine Oil Capacity and Specification.....	450
Engine Oil Dipstick Overview.....	449
Intelligent Oil Life Monitor.....	450
Resetting the Intelligent Oil Life Monitor.....	450
Engine Oil Pressure Gauge.....	131
Engine Oil Temperature Gauge.....	131
Engine Specifications - 6.7L Diesel.....	483
Engine Specifications - 6.8L, Gasoline.....	484
Engine Specifications - 7.3L, Gasoline.....	485
Environment.....	31
Evasive Steering Assist.....	343
Evasive Steering Assist Limitations.....	343
Switching Evasive Steering Assist On and Off.....	343
What Is Evasive Steering Assist.....	343
Event Data.....	28
Exit Warning.....	331
Exit Warning – Troubleshooting.....	333
Exit Warning Indicators.....	332
Exit Warning Limitations.....	331
Exit Warning Precautions.....	331
Exit Warning – Troubleshooting.....	333
Exit Warning – Information Messages.....	333
Export Unique Options.....	694
Extending the Exterior Mirrors.....	125
Exterior Bulbs.....	475
Changing a Front Fog Lamp Bulb.....	479
Changing a Front Turn Signal Lamp Bulb.....	478
Changing a Headlamp Bulb.....	477
Changing a High Mounted Stoplamp Bulb.....	481
Changing a License Plate Lamp Bulb.....	481
Changing a Rear Lamp Bulb.....	479
Changing a Rear Turn Signal Lamp Bulb.....	480
Changing a Reversing Lamp Bulb.....	481
Changing a Stoplamp Bulb.....	480
Exterior Bulb Specification Chart.....	475
Removing a Rear Lamp Assembly.....	477
Exterior Lamps.....	111
Exterior Lamps On Audible Warning.....	113
How Do Cornering Lamps Work.....	111
Switching the Cargo Lamps On.....	112
Switching the Daytime Running Lamps On and Off.....	111
Switching the Spot Lamps On and Off.....	112
Switching Welcome Lighting On and Off.....	113
Using the Front Fog Lamps.....	112
Using the Turn Signal Lamps.....	111
Exterior Lighting Control.....	109
Exterior Lighting.....	109
Adaptive Front Lighting.....	117
Autolamps.....	110
Automatic High Beam Control.....	114
Automatic High Beam Control – Troubleshooting.....	116
Exterior Lamps.....	111
Exterior Zone Lighting.....	113
Headlamps.....	109
Headlamps – Troubleshooting.....	110
Exterior Lighting Videos.....	117
Exterior Mirrors.....	124
Exterior Mirrors Videos.....	126
Exterior Overview.....	33
Exterior Zone Lighting.....	113
Exterior Zone Lighting Settings.....	114
Using the Exterior Zone Lighting.....	113
What Is Exterior Zone Lighting.....	113

F

Fail-Safe Cooling.....	429
Driving When Fail-Safe Mode Is Activated.....	430

Index

Fail-Safe Cooling Indicators.....	430
How Does Fail-Safe Cooling Work.....	429
What Is Fail-Safe Cooling.....	429
Fastening and Unfastening the Seatbelts.....	49
Feature Bar.....	559
Federal Highway Administration Regulation.....	667
Filling the Selective Catalytic Reduction System Tank.....	219
Filling the Selective Catalytic Reduction System Tank in Cold Weather.....	219
Filling the Selective Catalytic Reduction System Tank Using a Fuel Station Pump.....	220
Filling the Selective Catalytic Reduction System Tank Using a Portable Container.....	220
Flat Tire See: Changing a Flat Tire.....	530
Flat Tow See: Recreationally Towing Your Vehicle - 4x2.....	433
See: Recreationally Towing Your Vehicle - 4x4.....	431
Floor Mats.....	419
Folding the Exterior Mirrors - Vehicles With: Manual Folding Mirrors.....	124
With: Power Folding Mirrors.....	124
Foot Pedals See: Adjusting the Pedals.....	104
Ford Assistant.....	562
Ford Assistant – Frequently Asked Questions.....	562
Ford Assistant Settings.....	562
Using Ford Assistant.....	562
Ford Protect.....	584
Four-Wheel Drive.....	231
Four-Wheel Drive Modes.....	236
Four-Wheel Drive – Troubleshooting.....	237
Four-Wheel Drive Indicators.....	236
Four-Wheel Drive Limitations.....	233
Four-Wheel Drive Modes.....	236
Four-Wheel Drive High.....	236
Four-Wheel Drive Low.....	236
Two-Wheel Drive High.....	236
Four-Wheel Drive Precautions.....	233
Four-Wheel Drive – Troubleshooting.....	237
Four-Wheel Drive – Information Messages.....	238
Four-Wheel Drive – Warning Lamps.....	237
Four-Wheel Drive Videos.....	239
Four Wheels Down Tow See: Recreationally Towing Your Vehicle - 4x2.....	433
See: Recreationally Towing Your Vehicle - 4x4.....	431
Front Axle Fluid Capacity and Specification.....	240
Front Axle.....	240
Front Parking Aid.....	282
Front Parking Aid Audible Warnings.....	283
Front Parking Aid Limitations.....	282
Locating the Front Parking Aid Sensors.....	283
What is the Front Parking Aid.....	282
Front Seat Precautions.....	148
Front Seats.....	148
Heated Seats.....	155
Manual Seats.....	149
Massage Seats.....	154
Power Seats.....	151
Ventilated Seats.....	156
Fuel and Refueling.....	203
Fuel and Refueling – Troubleshooting.....	210
Fuel Quality.....	203
Refueling.....	207
Running Out of Fuel.....	207
Fuel and Refueling Precautions.....	203
Fuel and Refueling – Troubleshooting.....	210
Fuel and Refueling – Information Messages.....	211
Fuel and Refueling – Warning Lamps.....	210
Fuel Gauge.....	130
Fuel Gauge Limitations.....	131
Locating the Fuel Filler Door.....	131
What Is Distance to Empty.....	131
What Is the Fuel Gauge.....	130
What Is the Low Fuel Reminder.....	131
Fuel Quality.....	203
Selecting the Correct Fuel.....	203

Index

Selecting the Correct Fuel for Cold Weather.....	204
Fuel Tank Capacity - Diesel.....	209
Fuel Tank Capacity - Gasoline.....	210
Fuse Precautions.....	434
Fuses.....	434
Battery Fuse Box.....	439
Fuses – Troubleshooting.....	444
Interior Fuse Box.....	440
Under Hood Fuse Box.....	434
Fuses – Troubleshooting.....	444
Fuses – Frequently Asked Questions.....	444
G	
Garage Door Opener Additional Assistance.....	168
Garage Door Opener.....	165
Garage Door Opener Introduction.....	165
Garage Door Opener Precautions and Frequencies.....	165
General Maintenance Information.....	589
Glasses Holder.....	188
Locating the Glasses Holder.....	188
Glass Roof Bounce-Back.....	128
Overriding Glass Roof Bounce-Back.....	128
What Is Glass Roof Bounce-Back.....	128
Glass Roof.....	127
Glass Roof Bounce-Back.....	128
Global Opening.....	120
Switching Global Opening On and Off.....	121
Using Global Opening.....	121
What Is Global Opening.....	120
Glossary of Tire Terminology.....	504
Glove Compartment.....	184
Locking the Glove Compartment.....	184
Opening the Glove Compartment.....	184
H	
Headlamp Adjusting See: Adjusting the Headlamps.....	473
Headlamps.....	109
Adjusting the Level of the Headlamps.....	109
Headlamp Indicators.....	109
Switching Headlamp Exit Delay On and Off.....	109
Using the High Beam Headlamps.....	109
Headlamps – Troubleshooting.....	110
Headlamps – Frequently Asked Questions.....	110
Head Up Display.....	135
Head Up Display – Troubleshooting.....	136
Head Up Display Settings.....	135
Head Up Display – Troubleshooting.....	136
Head Up Display – Information Messages.....	136
Heated Seats.....	155
Heated Seat Precautions.....	155
Switching the Heated Seats On and Off.....	155
Heating See: Climate Control - Vehicles With: Automatic Temperature Control.....	138
See: Climate Control - Vehicles With: Manual Temperature Control.....	143
Hill Descent Control.....	275
Hill Descent Control – Troubleshooting.....	276
Hill Descent Control Indicator.....	275
Hill Descent Control Precautions.....	275
Hill Descent Control – Troubleshooting.....	276
Hill Descent Control – Information Messages.....	276
Hill Descent Control Videos.....	276
Hill Start Assist.....	264
Hill Start Assist – Troubleshooting.....	264
Hill Start Assist Precautions.....	264
Hill Start Assist – Troubleshooting.....	264
Hill Start Assist – Information Messages.....	264
Hill Start Assist Videos.....	264
Hitches.....	359
Fifth-Wheel Trailer Hitch.....	362
Hooking Up a Trailer Using a Weight-Distributing Hitch.....	360
Installing a Hitch.....	359
Hood Lock See: Opening and Closing the Hood.....	445
Horn.....	102
How Does 911 Assist Work.....	65

Index

How Does Adaptive Cruise Control With Stop and Go Work.....	295
How Does Blind Spot Information System Work.....	326
How Does Cross Traffic Alert Work.....	334
How Does Drive Mode Control Work.....	310
How Does Driver Alert Work.....	349
How Does Easy Entry and Exit Work.....	81
How Does Exit Warning Work.....	331
How Does Four-Wheel Drive Work - Excluding: Tremor.....	231
How Does Four-Wheel Drive Work - Tremor.....	232
How Does Hill Descent Control Work.....	275
How Does Hill Start Assist Work.....	264
How Does Onboard Scales Work.....	387
How Does Pre-Collision Assist Work.....	338
How Does Reverse Brake Assist Work.....	260
How Does Smart Hitch Work.....	385
How Does Speed Sign Recognition Work.....	346
How Does Stability Control Work.....	267
How Does the 360 Degree Camera Work.....	289
How Does the Diesel Particulate Filter Work.....	212
How Does the Electronic Locking Differential Work.....	247
How Does the Lane Keeping System Work.....	316
How Does the Rear Occupant Alert System Work.....	161
How Does the Safety Canopy™ Work.....	56
How Does the Selective Catalytic Reduction System Work.....	217
How Does Traction Control Work.....	265
How Does Trailer Backup Assistance Work.....	389
How Does Trailer Hitching Assistance Work.....	379
How Does Trailer Reverse Guidance Work.....	403
How Does Trailer Sway Control Work.....	378
How Do Personal Profiles Work.....	573
How Do the Front Airbags Work.....	55
How Do the Side Airbags Work.....	55
Hydraulic Power Steering.....	277
Checking the Hydraulic Power Steering Fluid.....	278
Hydraulic Power Steering Guidelines.....	277
Locating the Hydraulic Power Steering Fluid Reservoir.....	278
I	
Icon Glossary See: Symbols Glossary.....	21
Icons See: Symbols Glossary.....	21
Identifying Fuse Types.....	444
Identifying the Audio Unit.....	548
Identifying the Auxiliary Switch Wiring.....	583
Identifying the Climate Control Unit.....	138
Idle Timer.....	195
How Does Idle Timer Work.....	195
Idle Timer Precautions.....	195
Idle Timer Settings.....	195
What is Idle Timer.....	195
Ignition Switch - Vehicles With: Keyed Ignition.....	189
Inflating the Tires.....	510
Information On Demand Screen.....	559
Information on the Tire Sidewall.....	499
Inspecting the Tire for Damage.....	514
Inspecting the Tire for Wear.....	514
Inspecting the Wheel Valve Stems.....	518
Installing Child Restraints.....	38
Attaching the Front Seat Tether Strap.....	43
Attaching the Rear Seat Tether Strap.....	44
Combining the Seatbelt and Lower Anchors for Attaching Child Restraints.....	43
Installing a Child Restraint in a Center Seat.....	42
Using Lower Anchors and Tethers for Children.....	42
Using Seatbelts.....	38
Using Tether Straps.....	43

Index

Instrument Cluster Display.....	132
Instrument Cluster Display Main Menu - Vehicles With: 12 Inch Screen.....	133
Instrument Cluster Display Main Menu - Vehicles With: 4.2 Inch Screen.....	132
Instrument Cluster.....	129
Fuel Gauge.....	130
Instrument Cluster Overview - Vehicles With: 12 Inch Screen.....	130
Instrument Cluster Overview - Vehicles With: 4.2 Inch Screen.....	129
Integrated Trailer Brake Controller.....	373
Integrated Trailer Brake Controller - Troubleshooting.....	376
Integrated Trailer Brake Controller Precautions.....	373
Integrated Trailer Brake Controller - Troubleshooting.....	376
Integrated Trailer Brake Controller - Frequently Asked Questions.....	377
Integrated Trailer Brake Controller - Information Messages.....	376
Interior Air Quality.....	147
Interior Bulbs.....	482
Interior Bulb Specification Chart.....	482
Interior Fuse Box.....	440
Accessing the Interior Fuse Box.....	440
Identifying the Fuses in the Interior Fuse Box.....	441
Locating the Interior Fuse Box.....	440
Interior Lamp Function.....	118
Switching the Interior Lamp Function On and Off.....	118
What Is the Interior Lamp Function.....	118
Interior Lighting.....	118
Ambient Lighting.....	119
Interior Lamp Function.....	118
Interior Lighting - Troubleshooting.....	119
Interior Lighting - Troubleshooting.....	119
Interior Lighting - Frequently Asked Questions.....	119
Interior Mirror.....	123
Auto-Dimming Interior Mirror.....	123
Interior Mirror Precautions.....	123
Interior Overview.....	32
Introduction.....	19

J

Jump Starting the Vehicle.....	424
Jump Starting Precautions.....	424
Jump Starting the Vehicle.....	425
Preparing the Vehicle.....	425

K

Keyless Entry.....	79
Keyless Entry - Troubleshooting.....	80
Keyless Entry Limitations.....	79
Keyless Entry Settings.....	79
Keyless Entry - Troubleshooting.....	80
Keyless Entry - Frequently Asked Questions.....	80
Keyless Entry Videos.....	80
Keys and Remote Controls Audible Warnings - Vehicles With: Flip Key.....	74
Keys and Remote Controls Audible Warnings - Vehicles With: Push Button Start.....	74
Keys and Remote Controls.....	67
Keys and Remote Controls - Troubleshooting.....	74
Keys and Remote Controls - Troubleshooting.....	74
Keys and Remote Controls - Information Messages.....	74

L

Lane Centering.....	302
How Does Lane Centering Work.....	302
Lane Centering Alerts.....	304
Lane Centering Automatic Cancellation.....	304
Lane Centering Indicators.....	305
Lane Centering Limitations.....	303
Lane Centering Manual Cancellation.....	304
Lane Centering Precautions.....	302
Lane Centering Requirements.....	303
Switching Lane Centering On and Off.....	303
Lane Centering - Troubleshooting.....	305
Lane Centering - Information Messages.....	305
Lane Keeping System Indicators.....	319

Index

Lane Keeping System.....	316	Locating the Safety Compliance Certification Labels.....	352
Aid Mode.....	318	Locating the Tire label.....	498
Alert and Aid Mode.....	318	Locating the USB Ports.....	169
Alert Mode.....	317	Locating the Wireless Accessory Charger.....	182
Blind Spot Assist.....	319	Locating Your Vehicle.....	69
Blind Spot Assist with Trailer Coverage.....	320	Locking the Rear Window Controls - Crew Cab/SuperCab.....	121
Lane Keeping System - Troubleshooting.....	323		
Lane Keeping System Limitations.....	316	M	
Lane Keeping System Precautions.....	316	Maintenance.....	445
Lane Keeping System Settings.....	317	12V Battery.....	470
Lane Keeping System - Troubleshooting.....	323	12V Battery - Troubleshooting.....	473
Lane Keeping System - Frequently Asked Questions.....	324	Coolant.....	462
Lane Keeping System - Information Messages.....	323	Engine Air Filter.....	457
Launching or Retrieving a Boat or Personal Watercraft.....	368	Engine Oil.....	449
Limited Slip Differential.....	242	Exterior Bulbs.....	475
Linking or Unlinking a Personal Profile.....	573	Interior Bulbs.....	482
Live Traffic.....	575	Maintenance Precautions.....	445
Switching Live Traffic On and Off.....	575	Making and Receiving a Phone Call.....	568
What Is Live Traffic.....	575	Manually Dimming the Interior Mirror.....	123
Load Carrying.....	351	Manually Releasing the Electric Parking Brake.....	255
Load Carrying Precautions.....	351	Manually Shifting Gears.....	227
Loading Your Trailer.....	367	Manual Seats.....	149
Locating the 360 Degree Cameras.....	289	Adjusting the Head Restraint.....	149
Locating the Auxiliary Switches.....	582	Adjusting the Lumbar Support.....	151
Locating the Auxiliary Switch Wiring.....	582	Adjusting the Seat Backrest.....	151
Locating the Blind Spot Information System Sensors.....	327	Folding the Seats.....	158
Locating the Brake Fluid Reservoir.....	251	Head Restraint Components.....	149
Locating the Cross Traffic Alert Sensors.....	336	Installing the Head Restraint.....	150
Locating the Exit Warning Sensors.....	332	Moving the Seat Backward and Forward.....	150
Locating the Memory Function Buttons.....	164	Removing the Head Restraint.....	150
Locating the Outlets.....	175	Unfolding the Seats.....	158
Locating the Power Outlets.....	171	Massage Seats.....	154
Locating the Pre-Collision Assist Sensors.....	340	Adjusting the Massage Seat Settings.....	155
Locating the Rear View Camera.....	286	Massage Seat Limitations.....	154
		Media Control Buttons.....	548
		Memory Function.....	164
		Memory Function Precautions.....	164
		Mislock.....	76
		Mislock Limitations.....	76
		Switching Mislock On and Off.....	76

Index

What Is Mislock.....	76
Mobile Communications	
Equipment.....	667
Mobile Device Data.....	30
Moonroof	
See: Glass Roof.....	127
Motorcraft Parts - 6.7L Diesel.....	486
Motorcraft Parts - 6.8L, Gasoline.....	487
Motorcraft Parts - 7.3L, Gasoline.....	488
Muting the Audio.....	549

N

Navigation Map Updates.....	575
Navigation.....	575
Adjusting the Map.....	575
Live Traffic.....	575
Route Guidance.....	576
Setting a Destination.....	575
Waypoints.....	576
Neutral Towing	
See: Recreationally Towing Your Vehicle - 4x2.....	433
See: Recreationally Towing Your Vehicle - 4x4.....	431
Neutral Tow	
See: Recreationally Towing Your Vehicle - 4x2.....	433
See: Recreationally Towing Your Vehicle - 4x4.....	431

O

Off-Road Driving.....	414
Onboard Generator Indicators.....	175
Onboard Generator.....	174
Onboard Generator – Troubleshooting.....	178
Onboard Generator Precautions.....	174
Onboard Generator – Troubleshooting.....	178
Onboard Generator – Frequently Asked Questions.....	179
Onboard Generator – Information Messages.....	178
Onboard Scales Limitations.....	387
Onboard Scales.....	387
Opening and Closing the Flip Key.....	68

Opening and Closing the Glass Roof.....	127
Opening and Closing the Hood.....	445
Opening and Closing the Sliding Windows - Vehicles With: Power Sliding Rear Window.....	121
Opening and Closing the Sunshade.....	127
Opening and Closing the Windows.....	120
Opening the Tailgate.....	82
Opening the Tailgate From Inside Your Vehicle.....	85
Opening the Tailgate From Outside Your Vehicle.....	82
Opening the Tailgate Using the Remote Control.....	85
Operating the Doors From Inside Your Vehicle.....	75
Opening the Doors From Inside Your Vehicle.....	75
Unlocking and Locking the Doors Using the Central Locking.....	75
Operating the Doors From Outside Your Vehicle.....	75
Unlocking and Locking the Doors Using the Key Blade.....	75
Unlocking and Locking the Doors Using the Remote Control.....	75
Operating Your Vehicle With a Snowplow.....	420
OTA	
See: Software Update Settings.....	578
See: Vehicle Software Updates.....	578
Overriding Reverse Brake Assist.....	261
Overriding the Set Speed.....	301
Over the air	
See: Software Update Settings.....	578
Over-the-air	
See: Software Update Settings.....	578
See: Vehicle Software Updates.....	578
See: Vehicle Software Updates.....	578

P

Panorama Roof	
See: Glass Roof.....	127
Panoramic Roof	
See: Glass Roof.....	127
Parking Aid Indicators.....	283

Index

Parking Aid Precautions.....	280	Power Running Board Settings.....	99
Parking Aids.....	280	Power Running Boards.....	99
Front Parking Aid.....	282	Power Running Boards –	
Parking Aids – Troubleshooting.....	284	Troubleshooting.....	100
Rear Parking Aid.....	281	Power Running Boards –	
Parking Aids – Troubleshooting.....	284	Troubleshooting.....	100
Parking Aids – Information		Power Running Boards – Frequently Asked	
Messages.....	284	Questions.....	100
Parking Aids Videos.....	285	Power Seats.....	151
Passive Anti-Theft System.....	96	Adjusting the Head Restraint.....	152
How Does the Passive Anti-Theft System		Adjusting the Lumbar Support.....	154
Work.....	96	Adjusting the Seat Backrest.....	153
What Is the Passive Anti-Theft		Adjusting the Seat Cushion.....	153
System.....	96	Adjusting the Seat Height.....	154
Perchlorate.....	666	Head Restraint Components.....	151
Performing a System Reset.....	580	Installing the Head Restraint.....	153
Personal Profiles.....	573	Moving the Seat Backward and	
Phone Menu.....	566	Forward.....	153
Phone.....	566	Removing the Head Restraint.....	152
Phone Precautions.....	566	Power-Up	
Pickup Bed Anchor Points.....	356	See: Software Update Settings.....	578
Locating the Pickup Bed Anchor		See: Vehicle Software Updates.....	578
Points.....	356	Pre-Collision Assist Limitations.....	339
Pickup Bed Anchor Point Load		Pre-Collision Assist Precautions.....	338
Capacities.....	357	Pre-Collision Assist.....	338
Pickup Bed Anchor Point		Automatic Emergency Braking.....	342
Precautions.....	356	Distance Alert.....	342
Pickup Bed.....	356	Distance Indication.....	341
Pickup Bed Anchor Points.....	356	Evasive Steering Assist.....	343
Tailgate Anchor Points.....	357	Pre-Collision Assist –	
Pickup Bed Precautions.....	356	Troubleshooting.....	343
Pickup Bed Videos.....	358	Pre-Collision Assist –	
Playing Media Using Bluetooth®.....	572	Troubleshooting.....	343
Playing Media Using the USB Port.....	169	Pre-Collision Assist – Frequently Asked	
Post-Collision Braking.....	427	Questions.....	345
Post-Crash Alert System.....	426	Pre-Collision Assist – Information	
How Does the Post-Crash Alert System		Messages.....	344
Work.....	427	Pre-Collision Assist – Warning	
Post-Crash Alert System Limitations.....	427	Lamps.....	343
Switching the Post-Crash Alert System		Predictive Speed Assist.....	306
Off.....	427	Adjusting the Set Speed Tolerance.....	307
What Is the Post-Crash Alert		How Does Predictive Speed Assist	
System.....	426	Work.....	306
Power Outlet Indicators.....	172	Predictive Speed Assist Alerts.....	307
Power Outlet Limitations.....	171	Predictive Speed Assist Indicators.....	307
Power Outlet.....	171	Predictive Speed Assist Limitations.....	307
Power Outlet Precautions.....	171	Predictive Speed Assist Precautions.....	306
Power Running Board Precautions.....	99		

Index

Switching Predictive Speed Assist Mode On and Off.....	307
Predictive Speed Assist – Troubleshooting.....	308
Predictive Speed Assist – Information Messages.....	308
Preparing Your Vehicle for Storage.....	496
Programming the Garage Door Opener.....	166
Programming the Remote Control - Vehicles With: Flip Key.....	72
Programming the Remote Control - Vehicles With: Push Button Start.....	73
Properly Adjusting the Driver and Front Passenger Seats.....	62
Protecting the Environment.....	31
Puncture See: Changing a Flat Tire.....	530
Push Button Ignition Switch - Vehicles With: Push Button Start.....	190
R	
Radio Frequency Certification Labels.....	597
Blind Spot Information System Sensors.....	597
Body Control Module.....	605
Cruise Control Module.....	609
Integrated Keyhead Transmitter.....	614
Passive Anti-Theft System.....	619
Passive Key.....	624
Radio Transceiver Module.....	627
SYNC.....	631
Telematics Control Unit.....	638
Tire Pressure Monitoring System Sensors.....	641
Wireless Accessory Charging Module.....	658
Rear Axle Fluid Capacity and Specification.....	242
Rear Axle.....	242
Rear Occupant Alert System Audible Warnings.....	163
Rear Occupant Alert System Indicators.....	162
Rear Occupant Alert System Limitations.....	161
Rear Occupant Alert System Precautions.....	161
Rear Occupant Alert System.....	161
Rear Occupant Alert System Settings.....	162
Rear Parking Aid.....	281
Locating the Rear Parking Aid Sensors.....	281
Rear Parking Aid Audible Warnings.....	282
Rear Parking Aid Limitations.....	281
What is the Rear Parking Aid.....	281
Rear Seats.....	157
Heated Seats.....	159
Manual Seats.....	157
Rear View Camera Guide Lines.....	287
Rear View Camera Precautions.....	286
Rear View Camera.....	286
Rear View Camera Settings.....	287
Rear View Camera Settings.....	287
Switching Rear View Camera Delay On and Off.....	288
Zooming the Rear View Camera In and Out.....	287
Rebooting the Center Display.....	560
Recalling a Preset Position.....	164
Recovery Towing.....	428
Accessing the Front Towing Point.....	428
Recreationally Towing Your Vehicle - 4x2.....	433
Recreationally Towing Your Vehicle - 4x4.....	431
Refueling.....	207
Refueling System Overview.....	207
Refueling Your Vehicle.....	208
Releasing the Electric Parking Brake if the Vehicle Battery Has Run Out of Charge.....	256
Remote Control Limitations.....	67
Remote Start.....	137
Remote Start Settings.....	137
Removing and Installing the Tailgate.....	82
Removing the Key Blade - Vehicles With: Push Button Start.....	68
Removing Your Vehicle From Storage.....	497

Index

Repairing Minor Paint Damage.....	495
Replacement Parts	
Recommendation.....	666
Replacing a Lost Key or Remote Control.....	71
Replacing the Cabin Air Filter.....	147
Replacing the Front Wiper Blades.....	106
Reporting Safety Defects in	
Canada.....	596
Reporting Safety Defects in the United States.....	595
Resetting Ground Fault Detection.....	177
Resetting the Stopping Position - Vehicles With: Power Adjustable Steering Column.....	102
Resetting the Trip Computer.....	134
Resetting Tire Pressure Monitoring System.....	523
Resuming the Set Speed.....	294
Reverse Brake Assist Indicators.....	261
Reverse Brake Assist Precautions.....	260
Reverse Brake Assist.....	260
Reverse Brake Assist - Troubleshooting.....	262
Reverse Brake Assist - Troubleshooting.....	262
Reverse Brake Assist - Frequently Asked Questions.....	263
Reverse Brake Assist - Information Messages.....	262
Roadside Assistance.....	423
Rollover Warning.....	594
Route Guidance.....	576
Adjusting the Guidance Prompt	
Volume.....	576
Canceling Route Guidance.....	577
Repeating an Instruction.....	576
Running-In	
See: Breaking-In.....	418
Running Out of Fuel.....	207
Adding Fuel From a Portable Fuel Container.....	207
Filling a Portable Fuel Container.....	207
S	
Satellite Radio.....	551
Locating the Satellite Radio Identification Number.....	552
Satellite Radio Limitations.....	552
Satellite Radio Settings.....	552
Selecting a Channel.....	552
What Is Satellite Radio.....	551
Saving a Preset Position.....	164
Scheduled Maintenance.....	586
Seatbelt Extensions.....	54
Seatbelt Precautions.....	48
Seatbelt Reminder.....	52
How Does the Seatbelt Reminder Work.....	52
Seatbelt Reminder Audible Warnings.....	53
Seatbelt Reminder Indicators.....	53
Switching the Seatbelt Reminder On and Off.....	53
Seatbelts.....	48
Automatic Locking Mode.....	50
Seatbelt Reminder.....	52
Sensitive Locking Mode.....	50
Security.....	96
Anti-Theft Alarm System.....	96
Passive Anti-Theft System.....	96
Security - Troubleshooting.....	97
Security - Troubleshooting.....	97
Security - Frequently Asked Questions.....	98
Security - Information Messages.....	97
Selecting a Drive Mode.....	310
Selecting a Four-Wheel Drive Mode.....	235
Selecting a Personal Profile.....	574
Selecting the Audio Source.....	548
Selective Catalytic Reduction System Guidelines.....	219
Selective Catalytic Reduction System Precautions.....	217
Selective Catalytic Reduction System Requirements.....	219
Selective Catalytic Reduction System.....	217
Filling the Selective Catalytic Reduction System Tank.....	219

Index

Selective Catalytic Reduction System – Troubleshooting.....	222
Selective Catalytic Reduction System – Troubleshooting.....	222
Selective Catalytic Reduction System – Information Messages.....	223
Selective Catalytic Reduction System – Warning Lamps.....	222
Sending and Receiving a Text Message.....	569
Sensitive Locking Mode.....	50
How Does Sensitive Locking Mode Work.....	50
What is Sensitive Locking Mode.....	50
Service Data.....	28
Setting a Destination.....	575
Setting a Destination Using a Point of Interest.....	576
Setting a Destination Using a Predictive Destination.....	576
Setting a Destination Using a Recent Destination.....	576
Setting a Destination Using a Saved Destination.....	576
Setting a Destination Using the Map Screen.....	576
Setting a Destination Using the Text Entry Screen.....	575
Setting a Memory Preset.....	549
Settings Data.....	29
Settings.....	560
Setting the Adaptive Cruise Control Gap.....	299
Setting the Adaptive Cruise Control Speed.....	298
Setting the Blower Motor Speed.....	139
Setting the Clock and Date.....	549
Setting the Cruise Control Speed.....	293
Setting the Hill Descent Speed.....	275
Setting the Temperature.....	139
Setting the Trail Control Speed.....	270
Setting Up a Vehicle Hotspot.....	546
Setting Up the Trailer Backup Assistance for a Conventional Trailer.....	389
Applying the Trailer Reversing Aid Sticker.....	391
Calibrating the System.....	392
Configuring the Trailer.....	389
Trailer Sensor Installation.....	391
Setting Up the Trailer Backup Assistance for a Fifth-Wheel or Gooseneck Trailer.....	393
Calibrating the System.....	394
Configuring the Trailer.....	393
Trailer Sensor Installation.....	394
Setting Up Trailer Reverse Guidance for a Conventional Trailer.....	403
Applying the Trailer Reverse Aid Sticker.....	405
Calibrating the System.....	406
Configuring the Trailer.....	403
Trailer Sensor Installation.....	405
Signing In to Your Account.....	564
Sitting in the Correct Position.....	148
Smart Hitch Limitations.....	385
Smart Hitch.....	385
Snow Plowing Precautions.....	420
Snow Plowing.....	420
Snowplow Mode - Vehicles With: Snow Plow Mode.....	421
Snowplow Mode - Vehicles With: Snow Plow Mode.....	421
Switching Snowplow Mode On and Off.....	421
What Is Snowplow Mode.....	421
Software Update Indicators.....	579
Software Update Settings.....	578
Software Update	
See: Software Update Settings.....	578
See: Vehicle Software Updates.....	578
Sounding the Panic Alarm.....	69
Speed Control	
See: Cruise Control.....	293
Speedometer.....	130
Speed Sign Recognition Indicators.....	346
Speed Sign Recognition Limitations.....	346
Speed Sign Recognition Precautions.....	346
Speed Sign Recognition Settings.....	347
Speed Sign Recognition.....	346
Speed Sign Recognition – Troubleshooting.....	347

Index

Speed Sign Recognition – Troubleshooting.....	347
Speed Sign Recognition – Frequently Asked Questions.....	348
Speed Sign Recognition – Information Messages.....	347
Stability Control Indicator.....	269
Stability Control.....	267
Starter Switch See: Ignition Switch - Vehicles With: Keyed Ignition.....	189
Starting and Stopping the Engine – Precautions.....	189
Starting and Stopping the Engine.....	189
Automatic Engine Stop.....	195
Engine Block Heater.....	192
Idle Timer.....	195
Starting and Stopping the Engine – Troubleshooting.....	197
Starting the Engine.....	190
Stopping the Engine.....	193
Starting and Stopping the Engine – Troubleshooting.....	197
Starting and Stopping the Engine – Frequently Asked Questions.....	199
Starting and Stopping the Engine – Information Messages.....	198
Starting and Stopping the Engine – Warning Lamps.....	197
Starting the Engine.....	190
Restarting the Engine After Stopping It.....	192
Starting a Diesel Engine.....	191
Starting a Gasoline Engine.....	190
Status Bar.....	558
Steering.....	277
Hydraulic Power Steering.....	277
Steering – Troubleshooting.....	279
Steering – Troubleshooting.....	279
Steering – Information Messages.....	279
Steering Wheel.....	101
Stopping the Engine.....	193
Stopping the Engine When Your Vehicle is Moving.....	194
Stopping the Engine When Your Vehicle is Stationary.....	193
Storage.....	184
Center Console.....	185
Cup Holders.....	184
Glasses Holder.....	188
Glove Compartment.....	184
Under Seat Storage.....	185
Storing Your Vehicle.....	496
Sunroof See: Glass Roof.....	127
Switching Adaptive Cruise Control On and Off.....	298
Switching Air Conditioning On and Off.....	138
Switching All of the Interior Lamps On and Off.....	118
Switching Android Auto™ On and Off.....	571
Switching Apple CarPlay On and Off.....	571
Switching Blind Spot Information System On and Off.....	327
Switching Climate Control On and Off.....	138
Switching Cross Traffic Alert On and Off.....	336
Switching Cruise Control On and Off.....	293
Switching Defrost On and Off.....	138
Switching Driver Alert On and Off.....	350
Switching Easy Entry and Exit On and Off.....	81
Switching Exit Warning On and Off.....	332
Switching Four-Wheel Drive On and Off.....	234
Switching From Adaptive Cruise Control to Cruise Control.....	302
Switching Generator Mode On and Off.....	177
Switching Hill Descent Control On and Off.....	275
Switching Hill Start Assist On and Off.....	264
Switching Maximum Cooling On and Off.....	139
Switching Maximum Defrost On and Off.....	138
Switching Parking Aid On and Off - Vehicles With: Front Parking Aid.....	280

Index

Switching Parking Aid On and Off - Vehicles With: Rear Parking Aid.....	281
Switching Pre-Collision Assist On and Off.....	340
Switching Recirculated Air On and Off.....	138
Switching Reverse Brake Assist On and Off.....	261
Switching Stability Control On and Off.....	268
Switching Text Message Notification On and Off.....	570
Switching the Audio Unit On and Off.....	548
Switching the Electronic Locking Differential On and Off - 4x2.....	249
Switching the Electronic Locking Differential On and Off - 4x4.....	247
Switching the Front Interior Lamps On and Off.....	118
Switching the Hazard Flashers On and Off.....	424
Switching the Head Up Display On and Off.....	135
Switching the Heated Mirrors On and Off.....	139
Switching the Heated Rear Window On and Off.....	139
Switching the Heated Steering Wheel On and Off - Vehicles With: Heated Steering Wheel.....	103
Switching the Lane Keeping System Mode.....	317
Switching the Lane Keeping System On and Off.....	317
Switching the Outlets On and Off.....	176
Switching the Passenger Airbag On and Off.....	58
Switching the Rear Interior Lamps On and Off.....	118
Switching Traction Control On and Off.....	265
Switching Trail Control On and Off.....	270
Switching Trailer Backup Assistance On and Off.....	395
Switching Trailer Hitching Assistance On and Off.....	380

Switching Trailer Reverse Guidance On and Off.....	406
Switching Trailer Sway Control On and Off.....	378
Switching Trail Turn Assist On and Off.....	273
Switching Utility Idle Mode On and Off - Vehicles With: Flip Key.....	177
Symbols Glossary.....	21
Symbols Used On Your Instrument Cluster.....	23
Symbols Used on Your Vehicle.....	21
System Update See: Software Update Settings.....	578
See: Vehicle Software Updates.....	578

T

Tachometer.....	130
Tailgate Anchor Points.....	357
Locating the Tailgate Anchor Points.....	357
Tailgate Anchor Point Load Capacities.....	357
Tailgate Precautions.....	82
Tailgate Step.....	83
Accessing the Tailgate Step.....	83
Stowing the Tailgate Step.....	84
Tailgate.....	82
Closing the Tailgate.....	85
Opening the Tailgate.....	82
Tailgate Step.....	83
Tailgate - Troubleshooting.....	89
Tailgate - Troubleshooting.....	89
Tailgate - Frequently Asked Questions.....	90
Tailgate - Information Messages.....	89
Tailgate - Warning Lamps.....	89
Tailgate Videos.....	84
The Better Business Bureau Auto Line Program.....	594
The Mediation and Arbitration Program.....	595
Third Party Software Copyright Acknowledgment.....	597
Tire Care.....	510
Tire Pressure Monitoring System Limitations.....	522

Index

Tire Pressure Monitoring System Overview.....	521	Trail Control.....	270
Tire Pressure Monitoring System Precautions.....	522	Trail Control – Troubleshooting.....	272
Tire Pressure Monitoring System.....	521	Trail Control – Troubleshooting.....	272
Tire Pressure Monitoring System – Troubleshooting.....	527	Trail Control – Information Messages.....	272
Tire Pressure Monitoring System – Troubleshooting.....	527	Trailer Backup Assistance Precautions.....	389
Tire Pressure Monitoring System – Information Messages.....	529	Trailer Backup Assistance.....	389
Tire Pressure Monitoring System – Warning Lamps.....	527	Setting Up the Trailer Backup Assistance for a Conventional Trailer.....	389
Tire Replacement Requirements.....	505	Setting Up the Trailer Backup Assistance for a Fifth-Wheel or Gooseneck Trailer.....	393
Tire Rotation.....	518	Trailer Backup Assistance – Troubleshooting.....	398
Towing a Trailer Limitations.....	367	Trailer Backup Assistance – Troubleshooting.....	398
Towing a Trailer Precautions.....	366	Trailer Backup Assistance – Frequently Asked Questions.....	400
Towing a Trailer.....	366	Trailer Backup Assistance – Information Messages.....	398
Towing a Trailer – Troubleshooting.....	371	Trailer Brake Precautions.....	366
Towing Weights and Dimensions.....	369	Trailer Hitching Assistance Indicators.....	381
Towing a Trailer – Troubleshooting.....	371	Trailer Hitching Assistance Limitations.....	380
Towing a Trailer – Information Messages.....	371	Trailer Hitching Assistance Precautions.....	379
Towing a Trailer Videos.....	372	Trailer Hitching Assistance.....	379
Towing Weights and Dimensions.....	369	Trailer Hitching Assistance – Troubleshooting.....	383
Calculating the Maximum Loaded Trailer Weight for Your Vehicle.....	370	Trailer Hitching Assistance – Troubleshooting.....	383
Recommended Towing Weights.....	369	Trailer Hitching Assistance – Information Messages.....	383
What Is the Maximum Loaded Trailer Weight.....	370	Trailer Lighting Check.....	363
Towing Your Vehicle Precautions.....	431	Trailer Reverse Guidance Precautions.....	403
Towing Your Vehicle.....	431	Trailer Reverse Guidance.....	403
Towing Your Vehicle – Troubleshooting.....	433	Setting Up Trailer Reverse Guidance for a Conventional Trailer.....	403
Towing Your Vehicle – Troubleshooting.....	433	Trailer Reverse Guidance – Troubleshooting.....	409
Towing Your Vehicle – Information Messages.....	433	Trailer Reverse Guidance – Troubleshooting.....	409
Traction Control Indicator.....	265	Trailer Reverse Guidance – Frequently Asked Questions.....	411
Traction Control.....	265		
Traction Control – Troubleshooting.....	266		
Traction Control – Troubleshooting.....	266		
Traction Control – Information Messages.....	266		
Trail Control Indicators.....	271		
Trail Control Limitations.....	270		

Index

Trailer Reverse Guidance – Information Messages.....	409
Trailer Sway Control Precautions.....	378
Trailer Sway Control.....	378
Trailer Towing Hints.....	368
Trailer Towing Navigation.....	577
Trail Turn Assist Indicators.....	273
Trail Turn Assist Limitations.....	273
Trail Turn Assist Precautions.....	273
Trail Turn Assist.....	273
Trail Turn Assist – Troubleshooting.....	274
Trail Turn Assist – Troubleshooting.....	274
Trail Turn Assist – Frequently Asked Questions.....	274
Trail Turn Assist – Information Messages.....	274
Transfer Case Fluid Capacity and Specification.....	236
Transmission Fluid Temperature Gauge.....	131
Transporting the Vehicle.....	429
Trip Computer.....	134
Trip Data.....	134
Turbo Boost Gauge.....	131
U	
Under Hood Fuse Box.....	434
Accessing the Under Hood Fuse Box.....	434
Identifying the Fuses in the Under Hood Fuse Box.....	435
Locating the Under Hood Fuse Box.....	434
Under Hood Overview – 6.7L Diesel.....	446
Under Hood Overview – 6.8L, Gasoline.....	447
Under Hood Overview – 7.3L, Gasoline.....	448
Under Seat Storage.....	185
Locating the Under Seat Storage Compartment.....	185
USB Ports.....	169
Using Alexa Built-In.....	564
Using a Slide-In Camper.....	352
Using Keyless Entry.....	79
Using Onboard Scales.....	387
Using Power Take-Off.....	228
Using Progressive Range Selection.....	229
Using Remote Start.....	137
Using Smart Hitch.....	385
Using Snow Chains.....	507
Using the Center Console Work Surface.....	180
Using the Diesel Engine Exhaust Brake.....	258
Using the Instrument Cluster Display Controls.....	132
Using the Integrated Trailer Brake Controller.....	373
Using the Remote Control.....	67
Using the Trailer Backup Assistance Controller.....	395
Using the Trailer Backup Assistance Views.....	396
Using This Publication.....	20
Using Trailer Hitching Assistance.....	380
Using Trailer Reverse Guidance Views.....	407
V	
Vehicle Care.....	489
Cleaning the Exterior.....	490
Cleaning the Interior.....	493
Vehicle Care Videos.....	495
Vehicle Hotspot Settings.....	546
Vehicle Hotspot – Troubleshooting.....	547
Vehicle Hotspot – Frequently Asked Questions.....	547
Vehicle Hotspot.....	546
Vehicle Hotspot – Troubleshooting.....	547
Vehicle Identification Number.....	542
Locating the Vehicle Identification Number.....	542
Vehicle Identification Number Overview.....	542
Vehicle Identification.....	542
Vehicle Identification Number.....	542
Vehicle Software Updates.....	578
Vehicle Specifications.....	483
Vehicle System Reset.....	580

Index

Ventilated Seats.....	156	What Is Reverse Brake Assist.....	260
Switching the Ventilated Seats On and Off.....	156	What Is Smart Hitch.....	385
Ventilated Seat Precautions.....	156	What Is Speed Sign Recognition.....	346
Ventilation		What Is the 360 Degree Camera.....	289
See: Climate Control - Vehicles With:		What Is the Cabin Air Filter.....	147
Automatic Temperature Control.....	138	What Is the Catalytic Converter.....	225
See: Climate Control - Vehicles With: Manual Temperature Control.....	143	What Is the Diesel Particulate Filter.....	212
Venting the Glass Roof.....	128	What Is the Electric Parking Brake.....	255
Viewing the Tire Pressures.....	523	What Is the Electronic Locking Differential.....	247
Visual Search.....	32	What Is the Gross Axle Weight Rating.....	352
Voice Interaction.....	562	What Is the Gross Combined Weight Rating.....	353
Ford Assistant.....	562	What Is the Gross Vehicle Weight Rating.....	353
W		What Is the Head Up Display.....	135
Warranty Information.....	694	What Is the Integrated Trailer Brake Controller.....	373
Washers.....	106	What Is the Lane Keeping System.....	316
Adding Washer Fluid.....	107	What Is the Memory Function.....	164
Switching the Courtesy Wipe On and Off.....	107	What Is the Onboard Generator.....	174
Using the Windshield Washer.....	107	What Is the Power Outlet.....	171
Washer Fluid Specification.....	107	What Is the Rear Occupant Alert System.....	161
Washer Precautions.....	106	What Is the Rear View Camera.....	286
Washers		What Is the Selective Catalytic Reduction System.....	217
See: Wipers and Washers.....	105	What Is the Tire Pressure Monitoring System.....	521
Waxing Your Vehicle.....	495	What Is the Wireless Accessory Charger.....	182
Waypoints.....	576	What Is Traction Control.....	265
Adding a Waypoint.....	576	What Is Trail Control.....	270
Editing Waypoints.....	576	What Is Trailer Backup Assistance.....	389
What Are the Auxiliary Switches.....	582	What Is Trailer Hitching Assistance.....	379
What Is 911 Assist.....	65	What Is Trailer Reverse Guidance.....	403
What Is a Connected Vehicle.....	543	What Is Trail Turn Assist.....	273
What Is Alexa Built-In.....	564	What Is Utility Idle Mode - Vehicles With: Flip Key.....	177
What Is Blind Spot Information System.....	326	Wheel and Tire Information.....	498
What Is Cross Traffic Alert.....	334	Wheel Nuts.....	540
What Is Cruise Control.....	293	Wi Fi	
What Is Drive Mode Control.....	310	See: Connecting the Vehicle to a Wi-Fi Network.....	543
What Is Driver Alert.....	349		
What is Exit Warning.....	331		
What Is Ford Protect.....	584		
What Is Generator Mode.....	177		
What Is Hill Descent Control.....	275		
What Is Hill Start Assist.....	264		
What Is Onboard Scales.....	387		
What Is Pre-Collision Assist.....	338		

Index

Window Bounce-Back.....	121
Overriding Window Bounce-Back.....	121
What Is Window Bounce-Back.....	121
Windows Videos.....	122
Windows.....	120
Global Opening.....	120
Window Bounce-Back.....	121
Wipers and Washers –	
Troubleshooting.....	108
Wipers and Washers – Frequently Asked	
Questions.....	108
Wipers and Washers – Warning	
Lamps.....	108
Wipers and Washers Videos.....	108
Wipers and Washers.....	105
Autowipers.....	105
Washers.....	106
Wipers.....	105
Wipers and Washers –	
Troubleshooting.....	108
Wipers.....	105
Switching Windshield Wipers On and	
Off.....	105
Wiper Precautions.....	105
Wireless Accessory Charger	
Precautions.....	182
Wireless Accessory Charger	
Videos.....	183
Wireless Accessory Charger.....	182

