

# Toyota Sienna Hybrid

Northstar® Power Conversion



2024





## OWNER'S MANUAL

**Toyota Sienna Hybrid - 2024**  
**Northstar® Conversion**  
*with Access360®*



<b>Introduction</b>	<b>2</b>
Trademarks	3
Copyright © 2024 Vantage Mobility, LLC	3
Disclaimer	3
Record of Revisions	3
<b>Safety Precautions</b>	<b>4</b>
<b>Equipment Guide</b>	<b>6</b>
Vantage Mobility Installed Equipment	6
Vantage Mobility Dealer Installed Options	6
<b>Control Switch Operation</b>	<b>7</b>
Remote Control Operation	7
OEM Remote Keyless Entry Transmitter	7
Vantage Mobility Ramp Operation Remote	7
Power Sliding Door Overhead & Pillar Buttons	8
Dashboard and Passenger Control Switches	9
Kneel & Ramp Switches	10
LED Interior Lighting Operation	11

**Northstar® Conversion Manual Operation \_\_\_\_\_ 12**

Operate Door Manually ..... 12

Operate Ramp Manually ..... 12

**Seating and Securement \_\_\_\_\_ 14**

Removable Interchangeable Front Seats ..... 14

Wheelchair Restraint System ..... 16

Vehicle Load Capacity ..... 17

Restraint Belt Positioning ..... 19

Restraint System Attachment to Floor Track ..... 21

**Hybrid Safety Procedures \_\_\_\_\_ 23**

Hybrid Battery Service Disconnect Plug ..... 23

Hybrid Battery Placement ..... 23

Regular Battery Placement ..... 23

Running Out of Fuel ..... 23

**Emergency Procedures** ..... **24**

PowerKneel® Override ..... 24

Vehicle Towing Instructions ..... 24

Northstar® Ramp Emergency Manual Operation ..... 25

Emergency Flat Tire Repair ..... 26

**Maintenance and Warranty** ..... **27**

Vantage Mobility Conversion Scheduled Maintenance Plan ..... 28

Hybrid Battery Air Intake Vents and Filters ..... 29

Maintenance Log ..... 30

Vantage Mobility Limited Warranty ..... 38

Vantage Mobility/Toyota Service Information Form ..... 42

---

# INTRODUCTION

**Congratulations on the purchase of your new Toyota Sienna Minivan equipped with the Vantage Mobility Northstar® conversion.**

Vantage Mobility has designed and built your conversion with quality and safety in mind. We expect this new vehicle and conversion to provide you years of enjoyable transportation.

This manual is a supplement to the Toyota Owner's Manual. Please read both manuals as they contain important operational and safety information. We recommend you keep both manuals in your vehicle's glove box.

Your new vehicle may be equipped with special driving controls installed by your Vantage Mobility dealer to meet your individual driving needs. These may include hand controls, power assist brake and accelerator systems, and reduced effort steering and braking systems. Before driving the vehicle, you should obtain professional driver training on the proper use of these controls to understand how these modifications may affect the handling of your vehicle.

The Vantage Mobility conversion carries a limited warranty that covers the conversion modifications and alterations only. The Toyota vehicle carries a separate warranty. If a defect or a failure is a direct result of a Vantage Mobility modification, it will be covered under the Vantage Mobility Limited Warranty. A defect or failure on any original equipment NOT altered by Vantage Mobility is covered under the Toyota warranty. Please refer to the Vantage Mobility conversion maintenance requirements and the limited warranty information in this manual to familiarize yourself with the coverage and exclusions.

**SHOULD YOUR VEHICLE REQUIRE SERVICE OF ANY KIND, PLEASE CONTACT YOUR Vantage Mobility AUTHORIZED MOBILITY EQUIPMENT DEALER. TO LOCATE A DEALER IN YOUR AREA, PLEASE GO TO [VANTAGEMOBILITY.COM](http://VANTAGEMOBILITY.COM).**

**TRADEMARKS**

Product names mentioned in this manual may be trademarks or registered trademarks of their respective companies and are hereby acknowledged.

**COPYRIGHT © 2024  
VANTAGE MOBILITY, LLC**

This manual is proprietary to Vantage Mobility Holdings, LLC (Vantage Mobility) and is intended for the exclusive use of Vantage Mobility customers. No part of this document may in whole or in part, be copied, reproduced, distributed, translated or reduced to any electronic or magnetic storage medium without the express written consent of a duly authorized officer of Vantage Mobility.

**DISCLAIMER**

This manual was reviewed thoroughly for accuracy. All statements, technical information, and recommendations contained herein and in any guides or related documents are believed reliable, but the accuracy and completeness thereof are not guaranteed or warranted. They are not intended to be, nor should they be understood to be, representations or warranties concerning the products described.

Vantage Mobility is constantly improving its products and reserves the right to make changes in the specifications of products or in this manual at any time without notice and without obligation to notify any person of such changes.

**RECORD OF REVISIONS**

<b>Document Number</b>	<b>Revision Level</b>	<b>Date</b>	<b>Reason for Change</b>
DOC4302		April 2024	

## SAFETY PRECAUTIONS

- Read your Vantage Mobility and Toyota Owner's Manuals before operating the vehicle or any of its conversion equipment. There is important safety and operational information you must know to operate this vehicle and its equipment properly. Failure to do so may result in property damage or bodily injury.
- In addition to reading the manuals, you must ensure your Vantage Mobility dealer instructs you on the use of your conversion and its safety features before operating the vehicle or the conversion.
- There must be approximately 8 feet of clearance on the passenger side to allow safe ramp deployment plus an additional 4 feet for the wheelchair occupant to maneuver. Allow additional clearance if assistance is required.
- Before operating the ramp, make sure the vehicle's transmission is in PARK and the parking brake is SET. Failure to do so may result in property damage or bodily injury.
- Do not operate the ramp, load, or unload the vehicle if traffic or road conditions do not allow you to do so safely.
- All wheelchairs and scooters, occupied or not, must be properly restrained prior to vehicle operation. Failure to do so may result in property damage or bodily injury.
- Before activating any of the conversion control switches to close the door and stow the ramp, the ramp and door area must be clear of operator and bystanders. DO NOT operate if any person or object is on the ramp. Doing so may result in property damage or bodily injury.

### WARNING

Please familiarize yourself with the safety information provided in this manual. If you have any question or concerns regarding the proper operation of your vehicle or any of its safety features, please contact your Vantage Mobility dealer or call Vantage Mobility directly at 855-864-VANS (8267).

### WARNING

Beware of ramp slope!

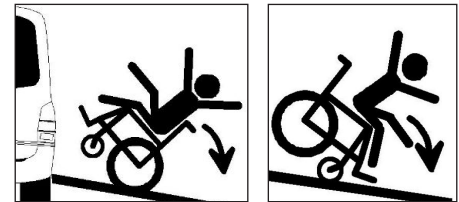

- All occupied wheelchairs **MUST** be facing forward to be properly secured.
- Stowable seats must be properly secured, latched, and locked before occupying seats or operating vehicle.
- Your vehicle has been fitted with a manual wheelchair-strap restraint system. You have been provided one set of four wheelchair restraint straps and one lap/shoulder belt extension strap. Though these restraints are widely used within our industry, they **DO NOT** guarantee successful and safe securement of wheelchairs or scooters.
- **DO NOT** sit in a scooter while the vehicle is in motion. If you plan to occupy a wheelchair while the vehicle is in motion, Vantage Mobility cannot guarantee the restraint system will adequately restrain the occupant and/or wheelchair if an accident occurs at any speed. Vantage Mobility relies solely on the warranties and representations made by the restraint belt set and wheelchair manufacturers.
- Your vehicle's fuel system has been modified by Vantage Mobility. Although the possibility of experiencing problems with the modified fuel system is unlikely, it is important that you be aware that these modifications were performed. If you experience any fuel system problems, contact your Vantage Mobility dealer or Toyota dealer immediately and discontinue the use of your vehicle until the issue is resolved.
- Your new vehicle may be equipped with special driving controls installed by your mobility dealer to meet your individual driving needs. These may include hand controls, power assist brake and accelerator systems, and reduced effort steering and braking systems. Before driving your vehicle, you should obtain professional driver training on the proper use of these controls to understand how these modifications may affect the handling of your vehicle.
- Before exiting the vehicle, the wheelchair occupant **MUST** check to make sure the door is open and the ramp is fully deployed to the ground.
- The wheelchair occupant may require assistance entering and exiting the vehicle, depending on the abilities of the person and the type of wheelchair system (motorized, presence of rear wheels, etc.) or scooter.
- Restraints should not be held away from the body by any obstacles such as wheelchair armrests. Ensure nothing is between the restraints and the occupant.
- Please adhere to all securement related instructions in this manual and the instructions in the restraint kit box before operating the vehicle. Improper use may result in, and may not be limited to, the occupant sliding under the restraints causing severe injury.

---

# EQUIPMENT GUIDE

To help you navigate this owner’s manual, have your mobility dealer indicate the items or options installed on your minivan conversion.

## VANTAGE MOBILITY INSTALLED EQUIPMENT

- Ramp Operation Remote Fab
- PowerKneel® Kneeling System
- Power Northstar® Ramp
- Removable & Interchangeable Front Seats with Bases
- Restraint System and Wheelchair Seating
- White LED lighting to illuminate cabin floor and ramp

## VANTAGE MOBILITY MOBILITY DEALER INSTALLED EQUIPMENT

---

---

---

---

---

---

---

## CONTROL SWITCH OPERATION

### REMOTE CONTROL OPERATION

Your Northstar conversion comes equipped with two separate remote fobs that will control the door and ramp, the OEM remote and a ramp operation remote

### OEM REMOTE KEYLESS ENTRY TRANSMITTER

The OEM key/remote for your vehicle will still operate as originally intended, separate from the accessible conversion key fob..

1. To open the door, press and hold the passenger side door button.
2. To close the door, press and hold the passenger side door button.
3. If the button is pressed while the door is opening or closing, the system will reverse the door.



### VANTAGE MOBILITY RAMP OPERATION REMOTE

The ramp operation remote for your vehicle will control the ramp separately from the door.

1. To deploy the ramp, press OUT.
2. To stow the ramp, press IN.

**NOTE:** The button must be pressed only once for deploying or stowing

**NOTE:** Make sure there is a clear path for the ramp to fully deploy.

**Disclaimer:** Once Ramp has stowed, there will be a six second delay before you are able to re-deploy.

**NOTE:** When remote button is pressed, a small blue LED on the top left will light up, indicating the remote is working and the battery is good. If the ramp doesn't operate, ensure the LED lights up. If not, use the other remote or an interior switch to deploy or stow the ramp, and contact your dealer.



### RAMP OPERATION

Please note that the OEM control system and the one-touch ramp control are separate entities. The following points clarify how the ramp system operates:

- When the ramp is **retracting (going in)**, there is no delay in the operation. Pressing the "OUT" button during this time will have no effect until the ramp is fully stowed.
- When the ramp is **extending (coming out)**, pressing the "IN" button will immediately stop the extension and reverse the ramp's direction, causing it to retract.

These safety features are designed to prevent unintentional ramp deployment or retraction during operation. Please ensure proper use to maintain safe and reliable ramp functionality.

**NOTE:** Allow approximately 8 feet for the ramp to deploy beyond the side of the vehicle plus an additional 4 feet for the wheelchair occupant to maneuver. You may wish to increase this distance if the wheelchair occupant requires assistance from another person.

### WARNING

**Be sure to stow the ramp before attempting to close the sliding door. The door will run into the ramp and may cause damage if the ramp is out.**

### WARNING

**Always make sure the passenger side sliding door is in the "full open position" before deploying the ramp**

### POWER SLIDING DOOR OVERHEAD BUTTON

Unlock Doors. The Power Sliding Door Overhead Button is located on the ceiling mounted switch panel between the front driver and passenger seats.



#### Open Function

Press and release the Power Sliding Door Overhead Button once to open the power sliding door. Press and release the Power Sliding Door Overhead Button once to close the power sliding door.

#### Close Function

If the Power Sliding Door Overhead Button is pressed while the door is opening or closing, the door will stop in place. If pressed again, the door will reverse.

### POWER SLIDING DOOR PILLAR BUTTON

Unlock Doors. The passenger side Power Sliding Door Pillar Button is located on the B Pillar between the front and middle doors. This button activates the sliding door.



#### Open Function

Press and release the Power Sliding Door Pillar Button once to open the power sliding door. Press and release the Power Sliding Door Pillar Button once to close the power sliding door.

#### Close Function

If the Power Sliding Door Pillar Button is pressed while the door is opening or closing, the door will stop in place. If pressed again, the door will reverse.

## DASHBOARD & PASSENGER CONTROL SWITCHES

### Ramp IN/OUT Button

There are two Ramp IN/OUT buttons available for operating the ramp:

1. Dashboard Button: Located on the dashboard to the left of the steering wheel, this button allows for convenient ramp control from the driver's seat.
2. Passenger Side Button: Positioned to the left of the sliding door on the passenger side, this additional interior toggle switch enables ramp operation directly from within the vehicle.

To operate the ramp, press the "OUT" button once to deploy the ramp. To retract the ramp, simply press the "IN" button once. The following guidelines explain how the ramp system functions:

- When the ramp is retracting (going in), there is no delay in the operation. Pressing the "OUT" button during this time will have no effect until the ramp is fully stowed.
- When the ramp is extending (coming out), pressing the "IN" button will immediately stop the extension and reverse the ramp's direction, causing it to retract.

These features ensure smooth and safe ramp operation for both entry and exit.

**NOTE:** Before deploying the ramp, make sure passenger sliding door is OPEN.

**NOTE:** If either of the sliding doors are open when battery power is restored, the door(s) must be closed manually before the conversion control switches will operate properly.



### **Kneel ON/OFF Switch**

The Kneel ON/OFF Switch is located on the dashboard to the left of the steering wheel.

When in the ON position, the vehicle will automatically kneel when any conversion function switch is activated. When in the OFF position, the VM PowerKneel® system is disabled, and the vehicle will not kneel. This should be used when deploying the ramp on a curb 4 inches or higher.

**NOTE:** To avoid damage to the ramp, make sure the Kneel switch is in the OFF position while deploying on the curb.

### **Ramp ON/OFF Switch**

The Ramp ON/OFF Switch is located on the dashboard to the left of the steering wheel.

When in the OFF position, the power ramp and PowerKneel® systems are disabled and only the power door is active. The PowerKneel® and ramp systems will not function when any conversion control switch is pressed; only the power doors will function using the OEM remote.



## LED INTERIOR LIGHTING OPERATION

Additional LED interior lighting may be included on your conversion.

### Light Bar Locations

White lighting is positioned in the following locations:

- A to B pillar, lower passenger side = 16" bar light
- A to B pillar, lower driver side = 16" bar light
- Center console, lower Vantage Mobility panel = 6" bar light
- B pillar, lower passenger side - Small round dome light
- C pillar, lower passenger side - Small round dome light



## Dash 3-Way Switch

Dash 3-way switch is located on the lower, center dash:

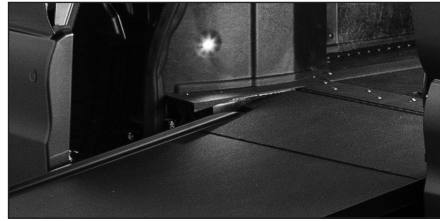

- I - Activated with dome lights
- O - OFF
- II - Activated with ignition on and while driving



# NORTHSTAR CONVERSION MANUAL OPERATION

## OPERATE DOOR MANUALLY

With the ramp in the fully stowed position, the sliding door may be opened or closed manually at any time. In order to open/close the door without power, the OEM power switch must be turned off. Refer to your Toyota Owner's Manual for operating instructions.

## NSTAR - WRENCH

In the event of an emergency or need to deploy the ramp out manually obtain the NSTAR wrench from underneath the rear bench.



### WARNING

**DO NOT** stow the ramp if a person is on the ramp. This could cause ramp system damage or serious bodily injury.

## OPERATE RAMP MANUALLY

Use the wrench to remove the cover plate on the floor by inserting the crank into the access hole and lifting the cover plate to access the wrench receiver.

**NOTE:** This access point is located on the conversion floor near the driver-side sliding door, providing access to the 3/8" square drive receiver.

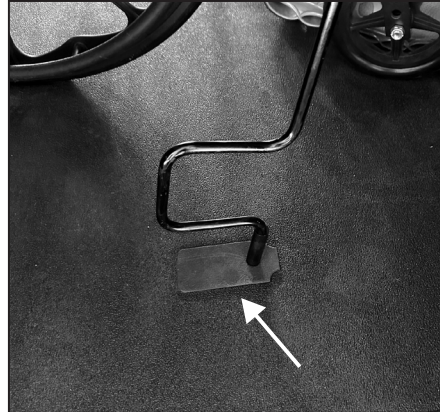

### WARNING

Turn ramp switch to **OFF** before manually operating the ramp. This allows the ramp to deploy without engaging the ramp motor.

**NOTE:** For emergencies or manual use, the in-floor ramp can be pulled out by hand. First, activate the ramp "OFF" button and ensure the operator is outside the vehicle and physically capable of performing the task.

**Deploy the Ramp:**

**Step 1:** Insert the pointed end of the wrench at an angle into the receiver and then pull to the vertical position to engage the gear.

**Step 2:** Push down on the handle as shown while rotating the crank counter-clockwise 90°. Relax your grip and allow the spring in the gear to return the wrench up and return the wrench (only) back 90° to its original starting position.

**Step 3:** Repeat step 2 until the ramp is fully deployed and resting on the ground.

**Retract the Ramp:**

**Step 1:** To retract the ramp, repeat the same process as the ramp deployment but in a clockwise manner until the ramp is fully stowed in the conversion floor and the crank reaches its stop point.

**NOTE:** Before turning the drive either clockwise or counter-clockwise, the 3/8" square drive is spring loaded and must be pushed down to ensure proper engagement

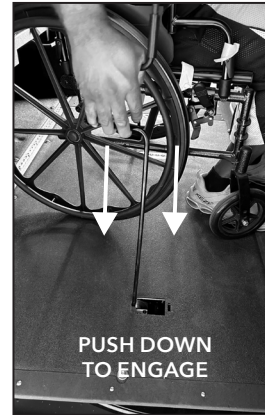
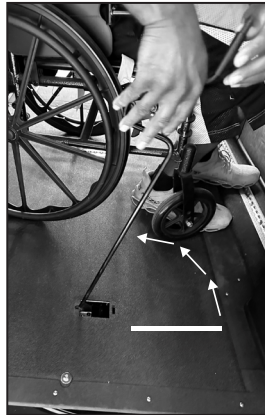
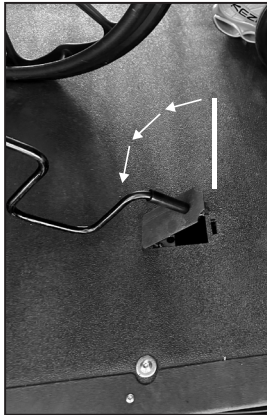

# SEATING AND SECUREMENT

## REMOVABLE INTERCHANGEABLE FRONT SEATS

Your Vantage Mobility Northstar® vehicle is equipped with removable and interchangeable driver and passenger front seats. If you wish to utilize the interchangeable front seat feature of your vehicle, you will need to have a Rigid Lap Belt Extension. If you do not have one, see your Vantage Mobility mobility dealer for details on ordering. Complete operation and installation instructions are included with the kit.

**NOTE:** Disconnect the seat wiring plugs prior to seat base removal from the minivan.

Failure to do so may result in damage to the seat wiring and the seat wiring harness.

**NOTE:** When the driver seat is installed in the passenger position and/or the passenger seat is installed in the driver position, the side seat airbag will be disabled.



### WARNING

The air bag warning light is an indication of a malfunction in the air bag system and must be serviced by an authorized service technician.

### Removing the Front Seats

1. Turn the vehicle ignition OFF.
2. Tilt the seat back forward to keep it from tipping backwards.
3. Disconnect seat wiring. Turn the outer ring of the cable connector counter-clockwise, and pull the cable out of the connector. Place the end of cable in the clip under the seat.

4. Pull the seat base release strap OUT. While holding the seat base release strap OUT, lift up the rear of the seat and pull it backwards.



### WARNING

Make sure ignition is OFF before disconnecting the harness.

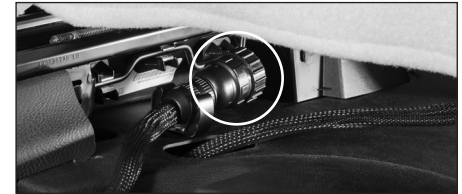

### WARNING

Make sure the seat is in the forward position before removal or it may fall backwards.

- Release the seat base release strap and lower the rear of the seat base to the floor of the vehicle. The rear seat base wheels will automatically lower so that the seat and base can be easily rolled out of the vehicle.



- Pull the seat out of the front securement brackets and remove seat from vehicle or move to the opposite position.

### Installing the Front Seats

The installation procedure is the reverse of the removal procedure.

- Make sure the vehicle ignition is OFF.
- Position the seat by rolling the seat forward over the seat anchors in the floor with the front seat base hooks aligned with the front securement brackets.
- Push the seat forward until the front seat base hooks engage with the front securement brackets.

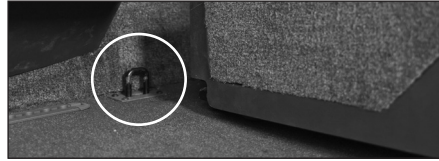

- Align rear seat latches over rear securement brackets.
- Step on wheel retraction lever to raise the rear wheels. The rear seat base latches will drop onto and engage the rear securement brackets.

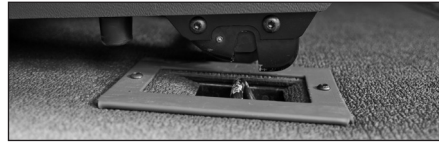

- Grasp the seat at the top of the seat back, pull back, and push forward to ensure the seat base has locked to the floor anchors.



- Align the yellow dot on the plug to the 12:00 position. Insert the seat base plug into the connector outlet and twist the outer ring clockwise until it locks.



### WARNING

Failure to ensure seat is secured to the vehicle floor may result in serious bodily injury.

### WARNING

Failure to reconnect seat base plug into the connector outlet will result in an inoperative power seat and a non-functional seat airbag.

### WHEELCHAIR RESTRAINT SYSTEM

Vantage Mobility includes a wheelchair restraint system in every conversion to secure a wheelchair while the van is in motion. This belt system includes four adjustable over-center buckle belts and one lap belt extension belt. While this manual contains instructions to use the system, the kit included with your conversion contains a more detailed set of instructions. Read both and consult with your Vantage Mobility dealer about the proper use of this system.

#### WARNING

The Vantage Mobility supplied wheelchair restraint system does meet the most widely referenced Federal Motor Vehicle Safety Standards used for contemporary restraint equipment. However, this equipment does not ensure stability of the wheelchair in the event of an accident at any speed.

Over-Center Belt (4 supplied)



Lap Belt Extension (1 supplied)



## VEHICLE LOAD CAPACITY

**SAFETY WARNING:** Loading of passengers and cargo should never exceed vehicle limits.

It is important that any operator of the Vantage Mobility Toyota Sienna conversion vehicle understands that the installation of adaptive equipment has necessarily added weight to the original Toyota vehicle, thereby reducing the load carrying capacity of the original vehicle. While the vehicle, as manufactured by Vantage Mobility, meets all applicable Federal Safety Standards concerning vehicle loading, it is important that the load carrying capacity never be exceeded.

Owners and Operators should carefully monitor their loading of passengers and cargo (defined to include any and all additional weight, added to the vehicle) to ensure that the capacity of the vehicle is never exceeded.

## WARNING

**Modifications to the original Toyota Sienna by Vantage Mobility and by any subsequent mobility dealer have reduced and limited the load capacity of the original vehicle. The total weight of passengers and cargo should never exceed the load capacity posted on the driver side door jamb. Overloading of the vehicle may negatively impact handling and could result in vehicle damage or failure while in use. It may not only cause damage to the tires, but also degrade steering and braking ability, resulting in an accident.**

The load carrying capacity of this modified vehicle is found on the ***Tire and Loading Information Label*** located on the driver side front door jamb. It is important that you know the capacity of your vehicle and that you and any operator of your vehicle monitor the loading of passengers and cargo to ensure that the weight capacity of the vehicle is not exceeded. Damage to the vehicle or vehicle systems from overloading may lead to catastrophic failure, either immediately or in the future, if this vehicle is operated in an overloaded condition.

In addition, a Vantage Mobility dealer or other adaptive equipment supplier may have added or installed adaptive equipment or other equipment to the vehicle. The primary user of the vehicle will likely use a mobility device (wheelchair or scooter). The weight of all this additional equipment and the mobility device must be included when calculating the combined load of cargo and passengers.

**Steps for Determining the Load Limit of This Vehicle**

1. Locate the statement “*The combined weight of the passengers and cargo should never exceed xxx kg or xxx lbs*” on the **Tire and Loading Information Label** in the vehicle, located on the driver side front door jamb.
2. Identify and determine the weight of all added adaptive equipment and mobility devices to be used in the vehicle. Consult your Vantage Mobility dealer if this is not clear to you.
3. Determine the additional combined weight of the driver and passengers and other cargo in the vehicle.
4. Subtract the weight of all added equipment, mobility device, and the combined weight of the driver and passengers from xxx kg or xxx lbs posted on the Tire and Loading Information Label.
5. The resulting figure equals the available amount of cargo and luggage load capacity and should never equal 0 or a negative number.

**Example:** If xxx = 1100 lbs, the added equipment and mobility device = 240 lbs and there will be four 150 lb passengers using this vehicle, the amount of available cargo capacity is 260 lbs (since 4 passengers x 150 lbs = 600 lbs and 1100 lbs - 240 lbs - 600 lbs = 260 lbs). The amount of additional passengers and cargo should not exceed the remaining 260 lbs.

Again, it is important to the safety of your vehicle, your passengers and those operating your vehicle, as well as those around you, that the owner and operator are always aware of the load capacity of your vehicle and confirm that the load capacity of the vehicle is not exceeded. A deterioration in handling, vehicle damage, and failure while in use may occur if systems are overloaded. You are responsible for the safe operation of your vehicle!

**Your Calculations:**

1. Total load capacity of your Vantage Mobility Toyota: \_\_\_\_\_ lbs
2. Weight of your additional adaptive equipment and mobility devices and operator’s weight (including wheelchair or scooter): \_\_\_\_\_ lbs
3. Subtract line 2 from line 1: \_\_\_\_\_ lbs
4. Add 100 lbs for each front seat removed: \_\_\_\_\_ lbs
5. Remaining capacity available for cargo and passengers on any trip: \_\_\_\_\_ lbs

## RESTRAINT BELT POSITIONING

The photos below show the locations of the standard floor tracks.

**NOTE:** Vantage Mobility does not provide wheelchair securement hardware for wheelchair drivers. Contact your mobility dealer for available options on the procedure for each of the four designated positions.

Front Tracks

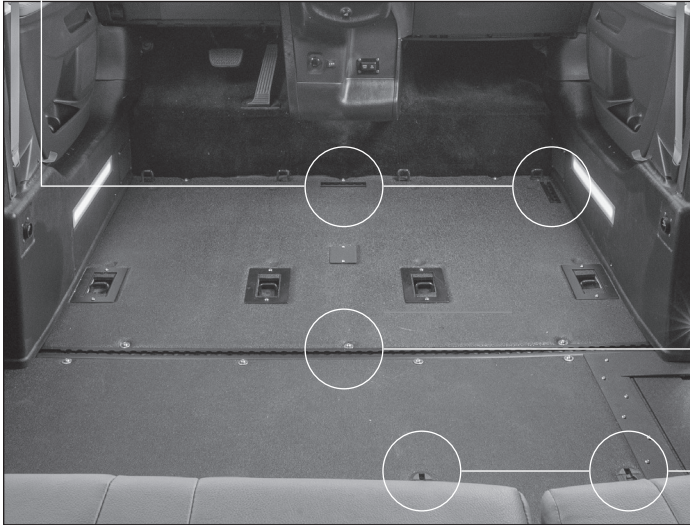

Middle Tracks

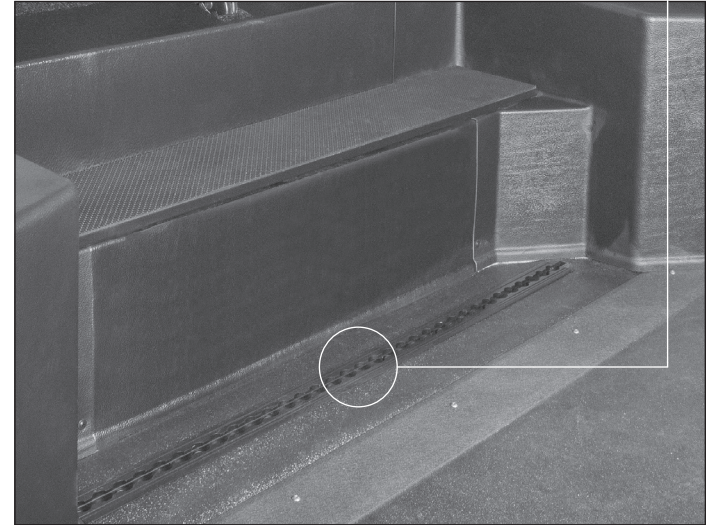

Rear Track

## SEATING AND SECUREMENT

There must be a straight line from the anchorage to the wheelchair attachment for proper belt angles. See **Figure 1** for proper belt angles.

Attach the tie down to a solid frame member of the wheelchair.

Ensure belts are under tension and not loose or sagging.

Install the tie down anchorage with center-to-center distance as shown in **Figure 2**.

Do not allow belts to be twisted inside the belt retractor. The recommended center-to-center distances are based on common wheelchair sizes. Exceptionally large or small wheelchairs may require anchorage spacing that differs from our recommendation. Use the belt angles from **Figure 1** to determine exact placement of the tie down in the "L" track.

Each of the four supplied tie downs secures the wheelchair to the vehicle's "L" tracks. The seat-belt extension is provided to use with the vehicle's seatbelts.

**Figure 1**

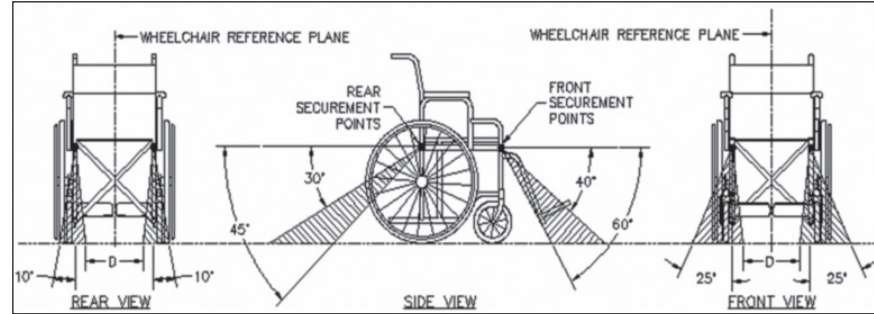

**Figure 2**

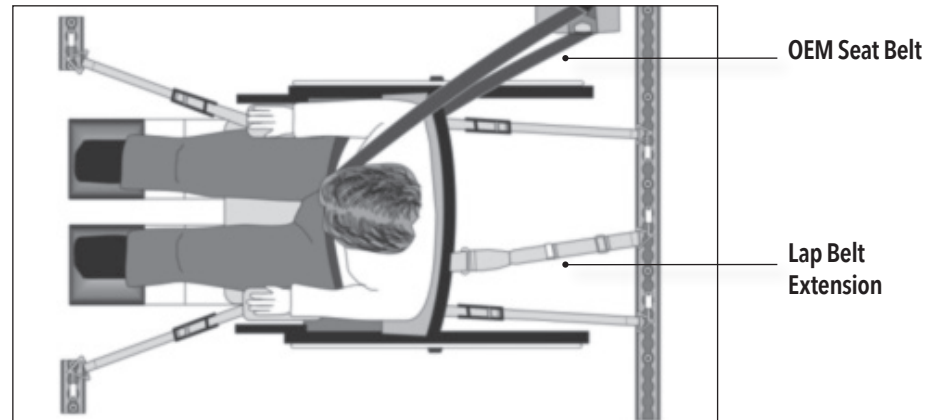

Rear: 13" to 15"    Front: 28" to 30"    Front to Rear: 44" to 54"

## RESTRAINT SYSTEM ATTACHMENT TO FLOOR TRACK

### Instructions for Use

1. Place wheelchair in the vehicle facing forward and in a suitable position.
2. Pre-select a position on the wheelchair to attach the hook and a position on the floor to attach the floor latch end of the strap.
3. Release the buckle latch on the strap. With the buckle released, pull the webbing to create enough slack so that the restraint belt can be attached to the floor and the wheelchair. Attach the restraint belt to the wheelchair.



4. Connect the floor latch to the pre-selected location on the floor track by pushing the fitting with even pressure into the track and slide the fitting in one direction until spring loaded latch drops into place. Pull on the strap to make sure it is secure.



5. Find the handhold strap and pull to tighten the strap. Make sure there are no twists or knots in the strap.



6. Lock buckle by pushing down until the buckle latch locks in place.

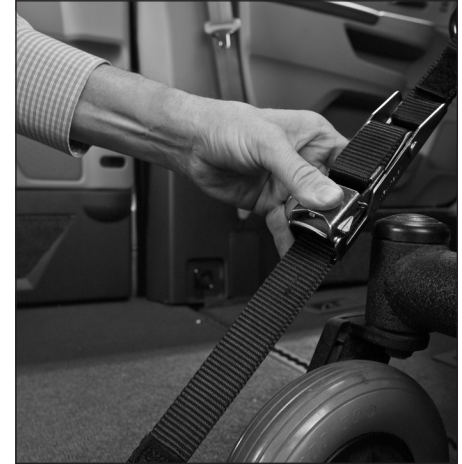

7. Ensure the same procedure is followed for all of the designated positions.

### Lap and Shoulder Belts

To secure an occupant in a wheelchair use the OEM seat belt in conjunction with the supplied lap belt extension. Clip the lap belt extension to the floor of the vehicle behind the wheelchair as shown in **Figure 2** on page 24. Insert the OEM seat belt tongue into the lap belt extension receptacle. When using the lap belt extension, do not route any belt over the side panel or the armrest of the wheelchair. The occupant must wear seat belts against the body and low across the front pelvis with the junction between the lap and shoulder belts located near the occupant's hips as shown in **Figure 3**.

Adjust the extension at the adjuster buckle. The lap and shoulder belts must not be held away from the body by the wheelchair or any of its components.

Adjust the belts firmly, consistent with user comfort. Use the vehicle belt height adjuster if necessary. The belts must not be twisted.

Figure 3

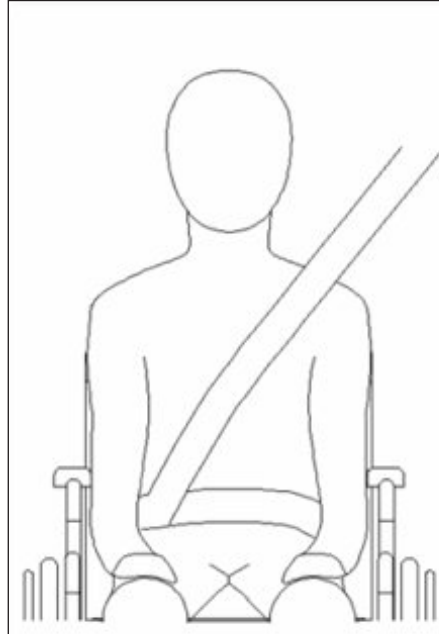

If the supplied lap and shoulder belts cannot secure the wheelchair occupant according to the instructions in this manual, contact your mobility dealer for other options.

### WARNING

If the belts do not restrain the body properly, the wheelchair must not be occupied during operation of the vehicle. Consult your mobility dealer if additional securement measures are necessary to ensure the wheelchair and occupant are secure.

# HYBRID SAFETY PROCEDURES

## WARNING

**Do not attempt to service hybrid related components on your own. Only service with a trained mechanic to avoid damaging the system.**

## HYBRID BATTERY SERVICE DISCONNECT PLUG

In the center of the floor, between the two front seats, there is a small access cover. Beneath that panel is the Hybrid Battery Service Disconnect Plug. This is where you remove power from the HIGH VOLTAGE BATTERY circuits.

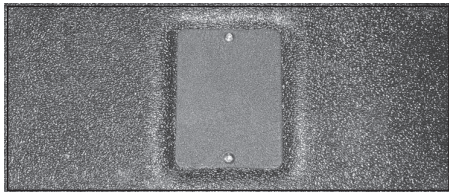

## HYBRID BATTERY PLACEMENT

The hybrid battery is located beneath the front seats under a floor plate. The floor plate should never be removed, and it should not be drilled through. A special plate for E-Z Lock wheelchair securement can be purchased as an accessory that bolts to designated areas of floor. Consult with your Vantage Mobility Authorized Dealer for more information.

## REGULAR BATTERY PLACEMENT

The 12v normal car battery is located in the rear quarter panel behind the rear bench in the passenger side access panel.

## RUNNING OUT OF FUEL

If there is only a small amount of fuel, the hybrid system may not be able to start.

The standard amount of fuel is about 3.1 gal. (11.9 L, 2.6 Imp. gal.), when the vehicle is on a level surface. This value may vary when the vehicle is on a slope. Add extra fuel when the vehicle is inclined.

---

# EMERGENCY PROCEDURES

## POWERKNEEL® OVERRIDE

If the PowerKneel® system becomes stuck in the DOWN position, use the override procedure until the system can be serviced by a Vantage Mobility mobility dealer.

Turn off the PowerKneel® switch located on the driver's side of the rear bench to activate the override procedure.



## VEHICLE TOWING INSTRUCTIONS

Refer to your Toyota Owner's Manual for proper vehicle towing instructions.

**NOTE:** *This vehicle can NOT be towed behind an RV on 4 wheels; it must be towed on a flatbed truck.*

## NORTHSTAR RAMP EMERGENCY MANUAL OPERATION

### NSTAR - WRENCH

In an emergency or manual use, use the NSTAR wrench from under the rear bench to manually deploy the ramp.



### Deploy the Ramp:

**Step 1:** Insert the 3/8" square drive at an angle into the receiver and then pull to the vertical position to engage the gear.

**Step 2:** Push down on the handle as shown while rotating the crank counter-clockwise 90°. Relax your grip and allow the spring in the gear to return the wrench up and return the wrench (only) back 90° to its original starting position.

**Step 3:** Repeat step 2 until the ramp is fully deployed and resting on the ground.

### Retract the Ramp:

**Step 1:** To retract the ramp, repeat the same process as the ramp deployment but in a clockwise manner until the ramp is fully stowed in the conversion floor and the crank reaches its stop point.

**NOTE:** Before turning the drive either clockwise or counter-clockwise, the 3/8" square drive is spring loaded and must be pushed down to ensure proper engagement

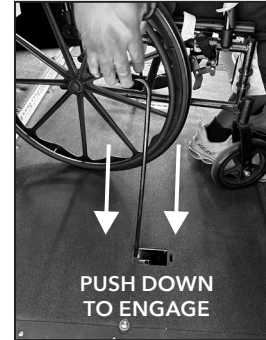
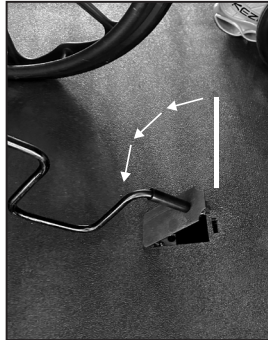

**NOTE:** For emergencies or manual use, the in-floor ramp can be pulled out by hand. First, activate the ramp "OFF" button and ensure the operator is outside the vehicle and physically capable of performing the task.

### EMERGENCY FLAT TIRE REPAIR

Standard equipment on the Vantage Mobility Toyota conversion is a tire sealant and inflation kit. These kits are widely used by auto manufactures in lieu of a spare tire and jack due to space constraints in modern vehicles.

#### Sealant and Inflation Kit

To repair a flat tire using the supplied tire sealant and inflation kit, locate and remove the kit from the storage compartment located in the vehicle's rear cargo area. Open the kit and follow the supplied instruction sheet. Refer to your Toyota Owner's Manual for detailed information concerning safety and the use of this equipment.

### Jack Pad Locations

Because the vehicle frame is modified as part of the conversion, the jacking locations have been relocated and special jack pads installed.

Shown here are the only Vantage Mobility-approved locations for the OEM jack to lift the vehicle safely. Using the OEM jack to lift the minivan from any other location may result in damage to the vehicle frame and/or conversion components and could result in serious bodily injury. The OEM jack should fit securely in the conversion jack pad.

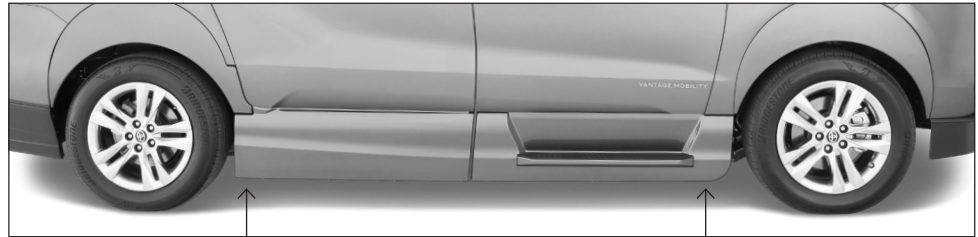
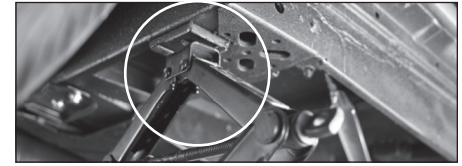

**Rear**  
in front of rear tire

**Front**  
behind front tire

---

## MAINTENANCE AND WARRANTY

It is important to perform scheduled inspection and maintenance on Vantage Mobility conversion products and restraint components to provide safe and trouble-free operation and to comply with the Vantage Mobility Limited Warranty. The following is the required minimum maintenance schedule to be followed.

**NOTE:** *Vehicles operated in environments subject to snow, road sand and salt, dust, rain, and temperature extremes may require maintenance that is more frequent.*



**VANTAGE MOBILITY CONVERSION SCHEDULED MAINTENANCE PLAN**

**NOTE:** If the Vantage Mobility Conversion Stow/Deploy front dash button blinks red 3 times at the end of a cycle, this means your 750-cycle preventative maintenance service is due. See page 8 for complete lighting indicators.

<b>Must be Performed Every 6 Months or 750 Ramp Cycles by an Authorized Vantage Mobility Dealer</b>	
<b>Power Door System</b>	<b>Ramp System</b>
<ul style="list-style-type: none"> <li>• Check proper door operation. Adjust door and/or limit switches as necessary.</li> <li>• Inspect and clean driver side and passenger side lower sliding door tracks and remove any debris from the track to ensure smooth door operation.</li> <li>• Check door cable for unusual wear or fraying. Check lower, middle and upper rollers for wear or damage; replace as required.</li> <li>• Inspect and replace normal wear items as required.</li> </ul>	<ul style="list-style-type: none"> <li>• Remove floor plate and inspect ramp operation.</li> <li>• Inspect ramp mechanism for loose fittings, alignment, and abnormal wear.</li> <li>• Clean and lubricate ramp drive mechanisms as needed.</li> <li>• Inspect and clean ramp sensors and limit switches.</li> <li>• Inspect and replace normal wear items as required.</li> </ul>

<b>Must be Performed Every 12 Months or 1,500 Ramp Cycles by an Authorized Vantage Mobility Dealer</b>	
<b>PowerKneel® System</b>	<b>Undercarriage Inspection</b>
<ul style="list-style-type: none"> <li>• Inspect entire PowerKneel® mechanism for loose fittings, alignment, and abnormal wear</li> <li>• Clean and lubricate kneel drive mechanisms</li> <li>• Inspect kneel switches</li> <li>• Verify PowerKneel® back up operation is functional</li> </ul>	<ul style="list-style-type: none"> <li>• Check undercarriage for component damage</li> <li>• Check undercarriage for rust or corrosion and repair as needed</li> <li>• Check electrical connection at battery for corrosion</li> <li>• Check main ground near Vantage Mobility control module</li> <li>• Inspect and replace normal wear items</li> </ul>

*Expenses associated with the above scheduled maintenance are not covered under the Vantage Mobility limited warranty program.*

## HYBRID BATTERY AIR INTAKE VENTS AND FILTERS

Vantage Mobility has relocated the hybrid battery air intake vents and filters to the lower front corners of the vehicle, underneath the driver and passenger seats.



To access the filter, you will need to remove the vent cover. The vent is located inside the snorkel as shown in the image below.

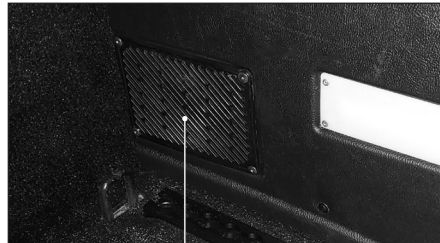
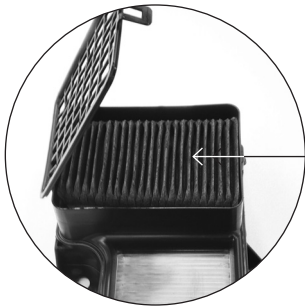

For more information about cleaning and replacing the hybrid battery air filter, consult your Toyota Owner's Manual.

## POWERKNEEL

Underneath the rear bench seat, there are conversion electrical systems including PowerKneel that may need to be serviced periodically. Please see your Vantage Mobility Authorized Dealer for service of these items and do not attempt to remove the rear bench or tamper with these devices.

**MAINTENANCE LOG**

Record maintenance information in the table below.

DATE	DATE	DATE
DESCRIPTION	DESCRIPTION	DESCRIPTION
DEALERSHIP	DEALERSHIP	DEALERSHIP

## MAINTENANCE LOG

Record maintenance information in the table below.

DATE	DATE	DATE
_____	_____	_____
DESCRIPTION	DESCRIPTION	DESCRIPTION
_____	_____	_____
_____	_____	_____
_____	_____	_____
_____	_____	_____
_____	_____	_____
_____	_____	_____
DEALERSHIP	DEALERSHIP	DEALERSHIP
_____	_____	_____

**MAINTENANCE LOG**

Record maintenance information in the table below.

DATE	DATE	DATE
DESCRIPTION	DESCRIPTION	DESCRIPTION
DEALERSHIP	DEALERSHIP	DEALERSHIP

## MAINTENANCE LOG

Record maintenance information in the table below.

DATE	DATE	DATE
_____	_____	_____
DESCRIPTION	DESCRIPTION	DESCRIPTION
_____	_____	_____
_____	_____	_____
_____	_____	_____
_____	_____	_____
_____	_____	_____
_____	_____	_____
DEALERSHIP	DEALERSHIP	DEALERSHIP
_____	_____	_____

**MAINTENANCE LOG**

Record maintenance information in the table below.

DATE	DATE	DATE
DESCRIPTION	DESCRIPTION	DESCRIPTION
DEALERSHIP	DEALERSHIP	DEALERSHIP

## MAINTENANCE LOG

Record maintenance information in the table below.

DATE	DATE	DATE
_____	_____	_____
DESCRIPTION	DESCRIPTION	DESCRIPTION
_____	_____	_____
_____	_____	_____
_____	_____	_____
_____	_____	_____
_____	_____	_____
_____	_____	_____
DEALERSHIP	DEALERSHIP	DEALERSHIP
_____	_____	_____

**MAINTENANCE LOG**

Record maintenance information in the table below.

DATE	DATE	DATE
DESCRIPTION	DESCRIPTION	DESCRIPTION
DEALERSHIP	DEALERSHIP	DEALERSHIP

## MAINTENANCE LOG

Record maintenance information in the table below.

DATE	DATE	DATE
_____	_____	_____
DESCRIPTION	DESCRIPTION	DESCRIPTION
_____	_____	_____
_____	_____	_____
_____	_____	_____
_____	_____	_____
_____	_____	_____
_____	_____	_____
DEALERSHIP	DEALERSHIP	DEALERSHIP
_____	_____	_____

## VANTAGE MOBILITY LIMITED WARRANTY

**The Vantage Mobility LIMITED WARRANTY modifies the standard Toyota LIMITED WARRANTY on this vehicle. Modifications to the vehicle made by Vantage Mobility, components installed by Vantage Mobility, and Toyota components and systems affected by Vantage Mobility modifications and components are NOT covered by the Toyota LIMITED WARRANTY.**

Vantage Mobility offers one of the most extensive conversion service warranties in the mobility industry. Our warranty, outlined herein, warrants the structural metal fabrication on or of the Vantage Mobility frame and components from rust-through corrosion or otherwise fail due to structural perforation for a period of 7 years (unlimited vehicle odometer miles). Surface corrosion on weld joints are excluded. Corrosion that resulted from damage to the conversion are excluded. **Prior to filing a claim for rust-through corrosion, the owner must provide verification of timely maintenance inspection for corrosion outlined in the Maintenance Schedule of this manual.**

**NOTE:** *Applies to 2024 model year chassis and newer with new conversions.*

The time periods will commence upon first delivery of the vehicle from Vantage Mobility or a Vantage Mobility dealer to the initial retail purchaser of the vehicle or the date that the vehicle was first placed into service, whichever comes first. Note that the Vantage Mobility Limited Warranty, which covers the Vantage Mobility conversion, is separate from the Toyota Limited Warranty, which covers components of the Toyota vehicle not affected by the conversion process.

The Vantage Mobility Limited Warranty will commence on the date the converted vehicle is delivered to the end-user. The Vantage Mobility warranty will be 36 months or 36,000 miles from the Odometer reading at the time of conversion. The 36 month, 36,000 mile Toyota Limited Warranty commences when the vehicle was originally sold to the first retail purchaser. Subject to the terms of the Vantage Mobility Limited Warranty, Vantage Mobility will repair or replace any Vantage Mobility factory installed part that is found to be defective within the above stated warranty period. Vantage Mobility will reimburse Vantage Mobility factory authorized repair facilities for labor costs associated in the repair or replacement of defective parts or workmanship. The reimbursement may be based on a Vantage Mobility "Flat Rate Schedule." Warranty work that is performed

at a facility that is NOT an authorized Vantage Mobility Service Facility will only be reimbursed to the amount determined by the flat rate schedule or a labor rate as determined by Vantage Mobility. Vantage Mobility reserves the right to designate where warranty work is to be performed and reserves the right to inspect any claim of defective workmanship or parts prior to authorization of repairs. Vantage Mobility makes no guarantee or representation as to the location of the nearest Vantage Mobility dealer or as to the convenience of having work done at such location. The Vantage Mobility Limited Warranty does not apply to parts or workmanship that becomes defective due to misuse, neglect, abuse, normal wear and tear, or accident by the operator of the vehicle or by unauthorized repair work.

For your approved Vantage Mobility factory authorized repair facility, you can go to our website at **VantageMobility.com** or contact us by mail or telephone:

**Vantage Mobility  
Customer Advocate Center  
5202 S. 28th Place  
Phoenix, AZ 85040  
855-862-VANS (8267)**

### **Transfer of Warranty**

If the vehicle is sold, the remainder of the Vantage Mobility Limited Warranty may be transferred to the second owner within 90 days of the purchase. To transfer the warranty, the new owner must send a written request to Vantage Mobility, including full name, address, phone number, and the Vantage Mobility ID number located on the inside driver door jamb.

### **Design Changes**

Vantage Mobility reserves the right to make design or process changes to improve its current product without any obligation to update or retrofit previously converted vehicles.

**Shipments of parts under the Vantage Mobility Limited Warranty will be sent by ground UPS only. If you request overnight or second-day shipment, that shipment will be sent freight collect.**

### **What Is Not Covered by This Limited Warranty**

The above stated warranty is the entire warranty made by Vantage Mobility to the purchaser. Specifically, Vantage Mobility does not warrant any other part or portion of the vehicle other than that manufactured by Vantage Mobility. Without limitation, this warranty is not intended to cover the vehicle's frame, engine, transmission, transaxle, front and rear wheel drive components, restraint systems (including airbags and seat belts), brakes, battery, heating system, air conditioning system, tires, ignition system, emission system, electronic and computer systems, or any other part of the vehicle, except for those fabricated, modified or altered by Vantage Mobility and then only to the extent of such fabrication, modification or alteration. This warranty is not intended to replace or substitute any other warranties issued by the original manufacturer of the vehicle or other supplier of parts or components thereto. Warranty claims regarding problems with any part of your vehicle not fabricated by Vantage Mobility will be referred to the original manufacturer of your vehicle. Consult the original manufacturer owner's manual for information regarding those warranties.

This warranty shall not cover any defect or problem existing in the vehicle at the time it arrives from the original vehicle manufacturer for subsequent modification by Vantage Mobility. Warranty claims regarding such pre-existing problems must be brought against the original manufacturer of the vehicle. Consult the original manufacturer owner manual for information regarding those warranties.

The Vantage Mobility Limited Warranty will not apply if the Vantage Mobility parts or Vantage Mobility modifications become defective due to use other than what is stated in the Vantage Mobility Owner's Manual.

The Vantage Mobility Limited Warranty does not cover towing, rental or loaner vehicles, lodging, travel expenses, lost wages, or any other incidental expenses associated with warranty repair.

The Vantage Mobility Limited Warranty is void if the vehicle is declared to be a total loss by an insurance company, the vehicle is rebuilt after being declared to be a total loss by an insurance company or the vehicle is issued a certificate of title indicating that it is designated as "salvage," "junk," "rebuilt," or "scrap" or some similar word.

Vantage Mobility will deny warranty coverage without notice if it learns that a vehicle is ineligible for coverage for any of these reasons.

This Warranty does not cover maintenance of the Vantage Mobility conversion. Maintenance shall be performed at owner's expense.

Vantage Mobility neither assumes, nor authorizes, any person to assume for it, any obligation or warranty other than herein stated.

### **Exclusion of Other Warranties**

This warranty is exclusive and in lieu of any warranty of merchantability, fitness for a particular purpose, or other warranty of quality, whether express or implied, and of all other liabilities and obligations on the part of Vantage Mobility.

### **Warranty Registration Requirement**

The warranty registration card must be completed by the Vantage Mobility dealer and returned to Vantage Mobility within 10 days of vehicle delivery to customer along with the Vantage

Mobility Pre Delivery Inspection checklist to validate any of the above stated warranties.

### **Your Rights Under State Law**

This warranty gives you specific legal rights, and you may have other rights that vary from state to state.

### **Summary of Warranty Coverage**

#### **Structural (Rust / Corrosion)\*:**

Warranted for 7-Years (unlimited miles) from rust-through corrosion (perforation) of the structural metal fabrication on or of the Vantage Mobility frame and components on new conversions from vehicle delivery date. Surface corrosion on weld joints are excluded. Corrosion that resulted from damage to the conversion are excluded.

**NOTE:** Applies to 2024 model year chassis and newer with new conversions.

#### **Electrical\*:**

3 Years / 36,000 Miles\*\* Parts and Labor

#### **Electro-Mechanical Kneeling System\*:**

3 Years / 36,000 Miles\*\* Parts and Labor

#### **Modified Seat Bases\*:**

3 Years / 36,000 Miles\*\* Parts and Labor

#### **Power Door Operators\*:**

3 Years / 36,000 Miles\*\* Parts and Labor

#### **Ramp System\*:**

3 Years / 36,000 Miles\*\* Parts and Labor

#### **Vantage Mobility Fabricated & Installed Equipment\*:**

3 Years / 36,000 Miles\*\* Parts and Labor

#### **Vantage Mobility Mechanical & Structural Conversion\*:**

3 Years / 36,000 Miles\*\* Parts and Labor

*\* Must follow the required maintenance schedule as outlined on page 32.*

*\*\* Whichever occurs first*

## How to Obtain Warranty Service

If you encounter any difficulties with your minivan, you should first contact the Vantage Mobility Mobility Equipment Dealer ("MED") from whom you purchased the minivan or, if you are outside that MED's local area, the nearest Vantage Mobility MED. A list of Vantage Mobility MEDs can be obtained by dialing 855-Vantage Mobility-VANS (864-8267).

If the Vantage Mobility MED believes that your problem would more effectively be dealt with by an authorized Toyota dealership (for example, if the problem pertains to automotive parts covered by the Toyota LIMITED WARRANTY), you will be referred to a local Toyota dealership for warranty service. If the minivan cannot be operated safely, transportation of your minivan to and from the Toyota dealership will be arranged by the MED and you will be advised by the MED where and when to pick up your vehicle. If the vehicle can be safely operated, it may be more efficient for you to drive the vehicle to the designated Toyota

dealership for warranty service, in which case you should make certain that the MED fills out the Service Information Form, and you should bring it to the designated Toyota dealership.

If you are unable to bring the vehicle to a MED and need to bring it to a Toyota dealer (for example, if you experience a problem where there is no MED nearby), please present the Service Information Card (pg 46) to the Service Manager of the Toyota Dealer. If you require help with this warranty or have any questions or comments, please contact Vantage Mobility at:

**Vantage Mobility Customer Advocate  
Center  
5202 S. 28th Place  
Phoenix, AZ 85040  
855-Vantage Mobility-VANS (864-8267)**

**VANTAGE MOBILITY/TOYOTA SERVICE INFORMATION FORM**

**Dear Toyota Dealer Service Manager:**

The Toyota customer presenting this form to you is the owner of a Toyota minivan converted by Vantage Mobility Holdings, LLC (Vantage Mobility) for wheelchair access and/or other mobility features. The minivan has been brought by the customer to the Vantage Mobility Mobility Equipment Dealer ("MED") listed below where it has been determined that the repair sought by the customer is most likely covered by the Toyota LIMITED WARRANTY and should be performed by an authorized Toyota Dealer.

**Description of Customer Problem(s):**

---

---

---

---

**MED Diagnosis:**

---

---

---

---

If you have any question about this diagnosis please contact the MED at:

**MED Name:** \_\_\_\_\_

**MED Phone Number:** \_\_\_\_\_

**Contact Person:** \_\_\_\_\_

If you believe that the service sought by the customer involves modifications to the vehicle made by Vantage Mobility, components installed by Vantage Mobility, or Toyota components and systems affected by Vantage Mobility modifications or components, you should contact Vantage Mobility Technical Support at **1-800-488-9082** prior to performing any service to determine whether Vantage Mobility or Toyota is responsible for the repair and whether you should make the repair or have the vehicle shipped to a Vantage Mobility repair facility. If you have any questions relating to this repair, you may also contact Toyota Technical Support at 1-800-331-4331.

Please photocopy this form for your records and return the original to the owner.







855-864-VANS • [VantageMobility.com](http://VantageMobility.com) • 5202 S 28<sup>th</sup> Place **Phoenix**, AZ 85040  
(8267)